

ALUTEC

ALUMINIUM RAINWATER SYSTEMS



Product & Installation Guide

January 2023



Marley Alutec is part of Aliaxis UK, comprising of Durapipe, GPS, Hunter Plastics, Marley Plumbing and Drainage, Multikwik, and Philmac.

About us

Marley Alutec is the UK leader in innovative aluminium guttering, rainwater drainage and eaves solutions.

Providing a complete service and product solution tailored to the needs of each project, we offer the most sustainable, durable and high-performance systems on the market.

Technical support

Our Technical Services team has many years of experience in all aspects of eaves and roof drainage design for both modern and traditional building methods. We can assist with:

- Correct system choice
- Roof drainage design calculation
- Installation advice
- Bespoke design service
- Scheduling quantities
- Fully itemised estimates

All Alutec product specifications and brochures can be downloaded from www.marleyalutec.co.uk

For further technical queries, please call our Technical Services Department on **01234 344108**.

Online calculators

Go to www.marleyalutec.co.uk/calculators to take advantage of our innovative online calculators



- Estimating tool – Produce instant list value estimates for all your Marley Alutec product requirements
- Rainwater drainage design tool – Ensure your pitched and flat roof projects are in full compliance with the rainwater drainage design standard (BS EN12056-3)
- Specification manager – Produce specification documents based on Marley Alutec's wide range of innovative aluminium rainwater products and eaves solutions

Building information modelling (BIM)

Marley Alutec is at the forefront of product and service innovation and has a full suite of BIM files for the rainwater and Evoke fascia and soffit ranges; to download them, visit www.marleyalutec.co.uk

CPD service



Alutec is a leading CPD provider for aluminium rainwater, fascia, soffit and coping systems. Our RIBA accredited CPD covers all aspects of eaves design, selection and correct installation. To date we have presented to over 5,000 construction industry professionals.

Standards

All Alutec systems are manufactured to and in excess of the appropriate BS or EN Standards.

Environmental



Marley Alutec is committed to continually reducing its environmental impact and is accredited to ISO 14001:2015.

Product availability

Our products are available through all major national and regional building, plumbing and roofing merchants, where you will be able to obtain discounts from the list price. Many of our products are delivered in just 2 days to the designated sites.

About Aluminium	04
Overview of Products	05
Colour Options	06
Gutter / Downpipe Selector Chart	07
Gutter Systems	08
Gutter Systems Profiles	09
Evolve Gutter Systems	10
Evolve Gutter Case Studies	11
Evolve Half Round Gutter	13
Evolve Deepflow Gutter	14
Evolve Box Gutter	15
Evolve Ogee Gutter	16
Traditional Gutter Systems	17
Traditional Gutter Case Studies	18
Traditional Half Round	20
Traditional Victorian Ogee	21
Traditional Moulded Ogee	22
Aligator® Gutter Systems	23
Aligator® Gutter Case Studies	24
Aligator® Classic Snap-Fit Ogee Gutter	26
Aligator® Deepflow Snap-Fit Gutter	27
Aligator® Ogee No.46 Snap-Fit Gutter	28
Aligator® Boxer Snap-Fit Gutter	29
Aligator® Giant Snap-Fit Gutter	30
Gutter Flow Capacity	31
Downpipes	33
Evolve 63mmØ Downpipe	34
Tudor Circular Downpipe	35
Flushfit Circular Downpipe	36
Traditional Square & Rectangular Downpipe	37
Flushfit Square & Rectangular Downpipe	38
Vandal Resistant Downpipe	39
Hopper Heads	40
Hopper Heads Case Studies	41
Hopper Heads	42
Hopper Head Flow Capacity	43
Installation Sundries and Sealant Usage Table	44
Fascia & Soffit Systems	45
Fascia and Soffit Case Studies	46
Fascia Type A and Fascia Type B	47
Fascia Type C and Soffit System	48
Installation Sundries	49
Coping Sytems	50
Coping Systems Case Studies	51
Coping Systems	52
Outlets	53
Elite Drainage Systems Info	54
Roof Outlets and Accessories	55
Parapet, Balcony, Car Park Outlets & Accessories	56
Traditional Balcony and Parapet Outlet Systems	57
Installation Guides	58
Installation Guides Contents	59
Evolve Half Round Gutter and 63mmØ Downpipe System	60
Evolve Deepflow Gutter System	62
Evolve Box and Ogee Gutter Systems	64
Traditional Gutter Systems	66
Aligator® Classic Gutter and Downpipe System	68
Aligator® Deepflow, Ogee 46 & Boxer Gutter System	70
Aligator® Giant Gutter System	72
Traditional Top and Side Rafter Arm	74
Tudor Downpipe System	75
Traditional Square & Rectangular Downpipe Systems	76
Flushfit Downpipe Systems	77
Vandal Resistant Downpipe	78
Coping Systems	79
Aluminium Composite Fascia & Soffit Systems	80
Aluminium Fascia & Soffit Systems	82
Outlets Typical Applications	84
General Info, Returns & Cancellation, Delivery Charges & Lead Times ...	90
Contacts	91

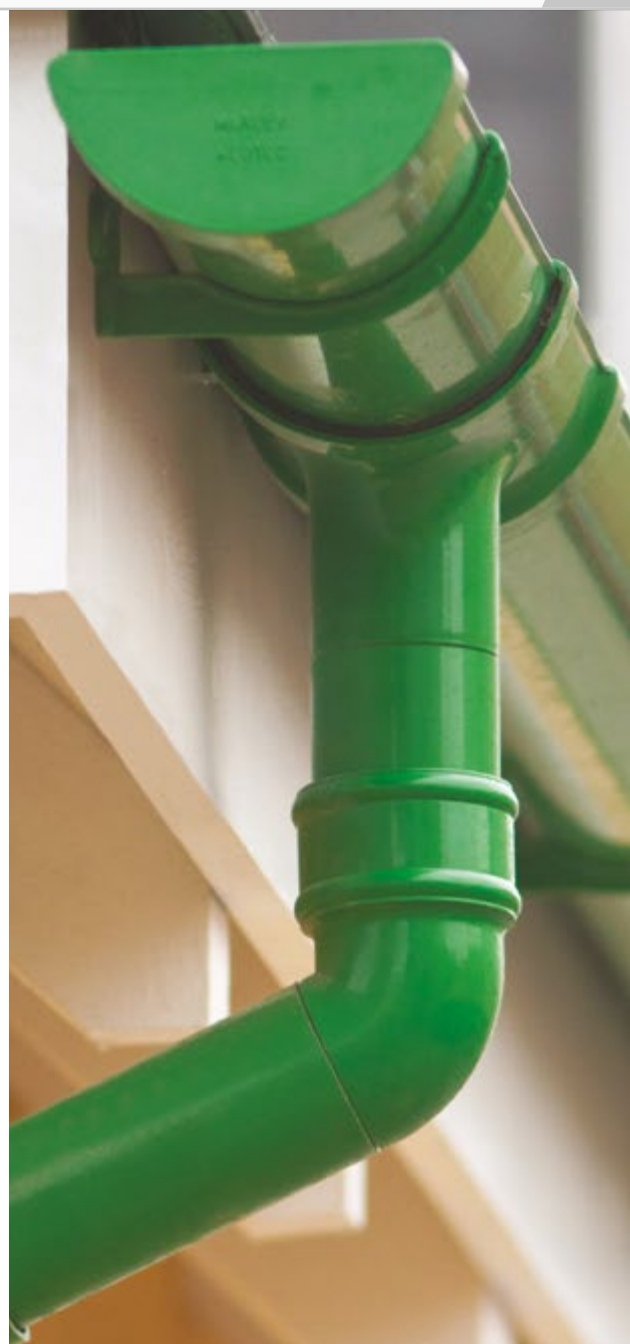



Re-roofing project with the Sheffield City Council, Sheffield

Aluminium - long lasting, low maintenance, sustainable

Made from marine grade aluminium, Alutec's products offer the very best in terms of durability, lasting for many years with minimal maintenance.

The properties of aluminium - a sustainable material

- Low whole life costs – compared to other materials
- Infinitely recyclable – 75% of all the aluminium produced since 1888 is still in use today
- Green energy – hydroelectric or geo-thermal power accounts for 60% of processing requirements

Lightweight, strong and long-lasting

Aluminium is a very light metal, about 65% lighter than steel or cast iron. It has a very high strength to weight ratio and excellent corrosion resistance.

Highly corrosion resistant Aluminium naturally generates a protective oxide coating. Should the surface be damaged, the aluminium simply oxidises again to protect itself. Add a polyester powder coating to provide an attractive and durable finish. This contrasts with steel, where galvanising only offers limited protection and cast iron, which requires regular repainting.

Infinitely recyclable

When the old Wembley Stadium (built in 1923) was demolished, 96% of the aluminium was recovered for recycling. Aluminium can be recycled again and again without loss of quality. The re-melting of aluminium requires little energy; it saves up to 95% of the energy required for primary aluminium production.

Responsible sourcing

Aluminium is the World's third most abundant element. 97% of all bauxite mines in the World operate rehabilitation projects and two thirds of the employees are from the local community. The amount of electrical energy required to produce aluminium has dropped by 70% since the 1880's and 60% of that electricity is provided from renewable green energy.

Gutters, downpipes and hoppers

Marley Alutec's total eaves solutions are available in a wide variety of aesthetics to suit all styles of property.



evolve

- As easy to install as PVC
- Industry leading flow rates reducing number of downpipes required
- Cost effective Heritage Black finish emulates appearance of cast iron



traditional

- Suitable for listed buildings and conservation areas
- Ideal for replacement of old cast iron system or reflect traditional styling of a new building
- Manufactured to original British Standard cast iron dimensions (BS 8530).



aligator

- Sleek and modern solution for rainwater disposal
- Snap-Fit boltless jointing systems reduces installation times by up to 40% compared to traditional bolted systems
- Manufactured using marine grade aluminium to withstand corrosion even in the harshest of environments

Fascia and soffit systems

evoke

Our Evoke range complements perfectly the long-life expectancy and low maintenance of Marley Alutec aluminium gutter and downpipe systems.

- Suitable for use up to 18m in height
- Installs like PVC, no specialist trades required
- Various profiles and sizes available
- Can be fixed directly to roof truss ends
- 12 different PVDF paint colour options that will naturally resist the buildup of dust, grime and algae; keeping maintenance costs to a minimum.

Our standard Fascia and Soffit systems are manufactured from 4mm thick aluminium composite material. These products are suitable for use up to a maximum height of 18m.

For installations carried out above 18 metres in height, and for non-standard colour requirements, our solid sheet aluminium products are available.

Coping systems

evoke

Marine grade aluminium coping system with a decorative polyester powder coated finish. Ideal for use where exceptional durability and aesthetics are key.

- Easy to position and fix without damage to panels
- Thickness of panels is 2mm (for up to 400mm wall width) or 3mm (for over 400mm wall width)
- Weathertight butyl adhesive seal - will maintain a 100% weathertight seal throughout its lifespan and outlast EPDM compression seals normally used in coping systems
- Fire rating A2-s1, d0 (Unlimited use)
- Choice of 19 architectural grade PPC range of standard RAL colours

Drainage outlets

elite

Our Elite range of roof and balcony drainage outlets are compatible with all waterproofing membranes and build-ups.

- Unrivalled flow performance
- Saves on project costs by reducing overall downpipe numbers
- Prevents cold bridging
- Unique and reliable clamping feature
- Simple and fast installation
- Anti-Vortex dome grate available
- Accompanying online roof drainage design software



All Alutec systems are available with an architectural grade polyester powder coat (PPC) paint finish.

Architectural grade PPC paint finishes are designed for exterior use and maintain their colour and gloss level for longer. Paint's life expectancy is enhanced further by Alutec's choice of aluminium.

We only use the highest quality marine grade aluminium, greatly increasing durability. The colour range includes Heritage Black, which has a textured surface to accurately replicate the appearance of traditional cast iron gutters and downpipes.

Standard colours for rainwater and coping systems



Additional colours, finishes and gloss levels are available, price on application. This chart is a representation of the actual colours, for exact match please ask for sample plates. **Mill finish is also available on request.**

The standard range of RAL colours are with 30% gloss level (unless otherwise stated).

Standard colours for fascia and soffit systems

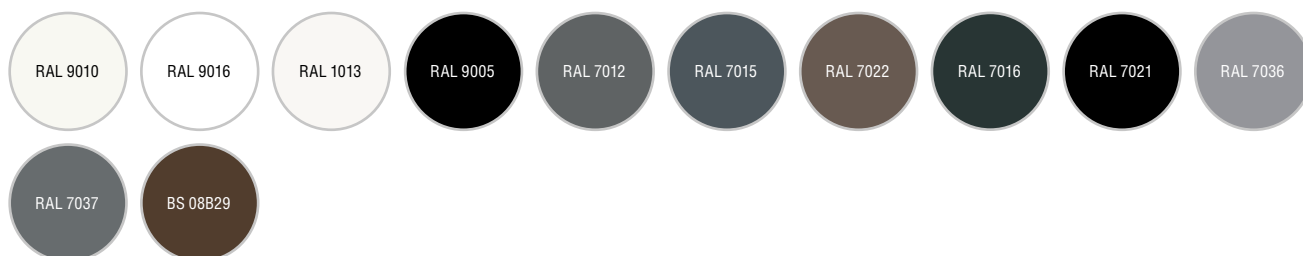













PVDF paint system to a 30-40% gloss level.

We are able to supply our Fascia and Soffit in non-standard colours, using aluminium sheet. Please call 01234 321996 for further information or email projects@marleyalutec.co.uk

Gutter / Downpipe Selector Chart



Use the table below to choose the right gutter and downpipe combination.

				DOWNPIPE SIZE					
				63mm Ø	76mm Ø	102mm Ø	72x72mm	102x76mm	102x102mm
GUTTER SYSTEMS	/ evolve	Half Round		✓	✓				
		Deepflow			✓				
		Box			✓		✓		
		Ogee			✓		✓		
	/ traditional	Half Round*		✓	✓	✓	✓	✓	
		Victorian Ogee*		✓	✓		✓	✓	
		Moulded Ogee*		✓	✓	✓	✓	✓	✓
	/ aligator	Classic		✓	✓		✓		
		Deepflow		✓	✓	✓	✓	✓	✓
		Ogee No. 46		✓	✓	✓	✓	✓	✓
		Boxer*		✓	✓	✓	✓	✓	✓
		Giant			✓	✓	✓	✓	✓















*Compatibility depends on gutter size chosen.



Gutter Systems

 evolve  traditional  aligator

A choice of different profiles to suit all types of applications and aesthetic requirements.

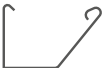
Gutter system profile	 evolve	 traditional	 aligator
Half Round	 123x51mm	 100mm 113mm 125mm	
Deepflow	 128x75mm		 130x80mm
Ogee	 130x95mm	 Victorian 100mm 113mm 125mm	 Classic 120x75mm
		 Moulded 100mm 125mm 150mm	 No. 46 155x100mm
Box	 130x85mm		 Boxer 120x80mm 135x100mm 160x100mm
Giant			 200x150mm



Evolve Ogee



Evolve Half Round



Evolve Deepflow



Evolve Box

Our range of Evolve aluminium guttering systems combine all the benefits of marine grade aluminium with installation as easy as PVC guttering.



Features of the Evolve range

Functional life expectancy of 50 years or more with minimal maintenance, only periodic aesthetic cleaning required.

Concealed fascia brackets on Box and Ogee profiles for a sleek and modern aesthetic.

Unique patented Jurajoint system for quick, simple and secure jointing.

Durable and strong - Marine grade extruded aluminium gutter sections and high pressure castings makes Evolve more corrosion resistant than steel or cast iron systems.

Fade resistant architectural grade polyester powder coat paint finish.

High flow rates reducing the number of downpipes required.

Available in the popular Heritage Black finish, with a textured surface to emulate the appearance of traditional cast iron.

19 standard colours.

Over 65% lighter than cast iron, making Evolve easier and safer to handle and install.

Land at End Rigg, A self-build property in Angus, Scotland



Hornsea School and Language College in Eastgate



Milestone Farm,
A private house in Norfolk





A modern refurbishment in Cawsand, Cornwall



A new eco-friendly property in Suffolk



St Catherine's View Care Home, Winchester







These products are compatible with all 63mmØ and 76mmØ downpipes



For delivery charges and lead times see page 90

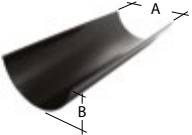
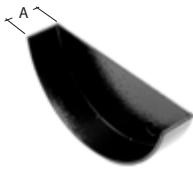
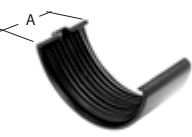
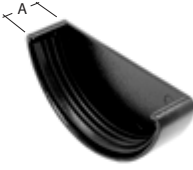
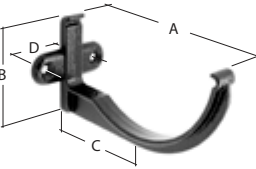
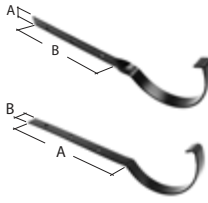

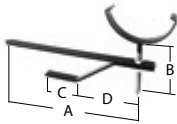
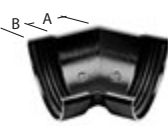
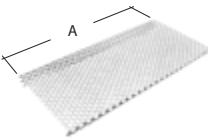
See page 6 for details of our standard colours
Please state colour when ordering

	<p>Gutter 3m</p> <table border="1"> <tr> <td>Code</td> <td>A</td> <td>B</td> </tr> <tr> <td>GT513</td> <td>123</td> <td>51</td> </tr> </table>	Code	A	B	GT513	123	51		<p>Stop end (internal)</p> <table border="1"> <tr> <td>Code</td> <td>A</td> </tr> <tr> <td>GT550</td> <td>25</td> </tr> </table>	Code	A	GT550	25												
Code	A	B																							
GT513	123	51																							
Code	A																								
GT550	25																								
	<p>Union</p> <table border="1"> <tr> <td>Code</td> <td>A</td> </tr> <tr> <td>GT520</td> <td>60</td> </tr> </table>	Code	A	GT520	60		<p>Stop end (external)</p> <table border="1"> <tr> <td>Code</td> <td>A</td> </tr> <tr> <td>GT555</td> <td>31</td> </tr> </table>	Code	A	GT555	31														
Code	A																								
GT520	60																								
Code	A																								
GT555	31																								
	<p>Fascia bracket Fix at 1m centres</p> <table border="1"> <tr> <td>Code</td> <td>A</td> <td>B</td> <td>C</td> <td>D</td> </tr> <tr> <td>GT580</td> <td>135</td> <td>66</td> <td>67</td> <td>38</td> </tr> </table>	Code	A	B	C	D	GT580	135	66	67	38		<p>Fixed rafter arm Fix at 1m centres</p> <table border="1"> <tr> <td>Code</td> <td>Description</td> <td>A</td> <td>B</td> </tr> <tr> <td>AC72</td> <td>Side</td> <td>20</td> <td>233</td> </tr> <tr> <td>AC75</td> <td>Top</td> <td>20</td> <td>233</td> </tr> </table>	Code	Description	A	B	AC72	Side	20	233	AC75	Top	20	233
Code	A	B	C	D																					
GT580	135	66	67	38																					
Code	Description	A	B																						
AC72	Side	20	233																						
AC75	Top	20	233																						
	<p>Angle 90°</p> <table border="1"> <tr> <td>Code</td> <td>A</td> <td>B</td> </tr> <tr> <td>GT532</td> <td>135</td> <td>28</td> </tr> </table>	Code	A	B	GT532	135	28		<p>Rise & fall bracket Fix at 1m centres</p> <table border="1"> <tr> <td>Code</td> <td>A</td> <td>B</td> <td>C</td> <td>D</td> </tr> <tr> <td>AC92</td> <td>360</td> <td>125</td> <td>80</td> <td>168</td> </tr> </table>	Code	A	B	C	D	AC92	360	125	80	168						
Code	A	B																							
GT532	135	28																							
Code	A	B	C	D																					
AC92	360	125	80	168																					
	<p>Angle 135°</p> <table border="1"> <tr> <td>Code</td> <td>A</td> <td>B</td> </tr> <tr> <td>GT537</td> <td>64</td> <td>28</td> </tr> </table>	Code	A	B	GT537	64	28		<p>Leafguard Mill finish</p> <table border="1"> <tr> <td>Code</td> <td>A</td> </tr> <tr> <td>SL70</td> <td>1220</td> </tr> </table>	Code	A	SL70	1220												
Code	A	B																							
GT537	64	28																							
Code	A																								
SL70	1220																								
<p>Angle TBC when ordering</p>	<p>Non standard angle</p> <table border="1"> <tr> <td>Code</td> </tr> <tr> <td>GT539</td> </tr> </table>	Code	GT539		<p>Compatible fixing screws Roundhead fascia bracket screw. Mill finish</p> <table border="1"> <tr> <td>Code</td> <td>Description</td> </tr> <tr> <td>SC201</td> <td>5 x 30mm</td> </tr> </table>	Code	Description	SC201	5 x 30mm																
Code																									
GT539																									
Code	Description																								
SC201	5 x 30mm																								
	<p>Outlet</p> <table border="1"> <tr> <td>Code</td> <td>Size</td> <td>A</td> <td>B</td> <td>C</td> <td>Fascia to outlet centre</td> </tr> <tr> <td>GT522</td> <td>(63mmØ)</td> <td>200</td> <td>140</td> <td>62</td> <td>67</td> </tr> <tr> <td>GT523</td> <td>(76mmØ)</td> <td>200</td> <td>140</td> <td>62</td> <td>67</td> </tr> </table>	Code	Size	A	B	C	Fascia to outlet centre	GT522	(63mmØ)	200	140	62	67	GT523	(76mmØ)	200	140	62	67		<p>Joint sealant 310ml tube, clear. All joints must be sealed using Alutec's SC101. Sealant usage table on page 44</p> <table border="1"> <tr> <td>Code</td> </tr> <tr> <td>SC101</td> </tr> </table>	Code	SC101		
Code	Size	A	B	C	Fascia to outlet centre																				
GT522	(63mmØ)	200	140	62	67																				
GT523	(76mmØ)	200	140	62	67																				
Code																									
SC101																									



These products are compatible with 76mmØ downpipes



For delivery charges and lead times see page 90



See page 6 for details of our standard colours
Please state colour when ordering

	<p>Gutter 3m</p> <table border="1"> <tr> <td>Code</td> <td>A</td> <td>B</td> </tr> <tr> <td>GE513</td> <td>128</td> <td>75</td> </tr> </table>	Code	A	B	GE513	128	75		<p>Stop end (internal)</p> <table border="1"> <tr> <td>Code</td> <td>A</td> </tr> <tr> <td>GE550</td> <td>35</td> </tr> </table>	Code	A	GE550	35												
Code	A	B																							
GE513	128	75																							
Code	A																								
GE550	35																								
	<p>Union</p> <table border="1"> <tr> <td>Code</td> <td>A</td> </tr> <tr> <td>GE520</td> <td>86</td> </tr> </table>	Code	A	GE520	86		<p>Stop end (external)</p> <table border="1"> <tr> <td>Code</td> <td>A</td> </tr> <tr> <td>GE555</td> <td>39</td> </tr> </table>	Code	A	GE555	39														
Code	A																								
GE520	86																								
Code	A																								
GE555	39																								
	<p>Fascia bracket Fix at 1m centres</p> <table border="1"> <tr> <td>Code</td> <td>A</td> <td>B</td> <td>C</td> <td>D</td> </tr> <tr> <td>GE580</td> <td>140</td> <td>90</td> <td>70</td> <td>38</td> </tr> </table>	Code	A	B	C	D	GE580	140	90	70	38		<p>Fixed rafter arm Fix at 1m centres</p> <table border="1"> <tr> <td>Code</td> <td>Description</td> <td>A</td> <td>B</td> </tr> <tr> <td>AE73</td> <td>Side</td> <td>20</td> <td>233</td> </tr> <tr> <td>AE76</td> <td>Top</td> <td>20</td> <td>233</td> </tr> </table>	Code	Description	A	B	AE73	Side	20	233	AE76	Top	20	233
Code	A	B	C	D																					
GE580	140	90	70	38																					
Code	Description	A	B																						
AE73	Side	20	233																						
AE76	Top	20	233																						
	<p>Angle 90°</p> <table border="1"> <tr> <td>Code</td> <td>A</td> <td>B</td> </tr> <tr> <td>GE532</td> <td>144</td> <td>35</td> </tr> </table>	Code	A	B	GE532	144	35		<p>Rise & fall bracket Fix at 1m centres</p> <table border="1"> <tr> <td>Code</td> <td>A</td> <td>B</td> <td>C</td> <td>D</td> </tr> <tr> <td>AE93</td> <td>360</td> <td>125</td> <td>80</td> <td>168</td> </tr> </table>	Code	A	B	C	D	AE93	360	125	80	168						
Code	A	B																							
GE532	144	35																							
Code	A	B	C	D																					
AE93	360	125	80	168																					
	<p>Angle 135°</p> <table border="1"> <tr> <td>Code</td> <td>A</td> <td>B</td> </tr> <tr> <td>GE537</td> <td>64</td> <td>28</td> </tr> </table>	Code	A	B	GE537	64	28		<p>Leafguard Mill finish</p> <table border="1"> <tr> <td>Code</td> <td>A</td> </tr> <tr> <td>SL75</td> <td>1220</td> </tr> </table>	Code	A	SL75	1220												
Code	A	B																							
GE537	64	28																							
Code	A																								
SL75	1220																								
<p>Angle TBC when ordering</p>	<p>Non standard angle</p> <table border="1"> <tr> <td>Code</td> </tr> <tr> <td>GE539</td> </tr> </table>	Code	GE539		<p>Compatible fixing screws Roundhead fascia bracket screw. Mill finish</p> <table border="1"> <tr> <td>Code</td> <td>Description</td> </tr> <tr> <td>SC201</td> <td>5 x 30mm</td> </tr> </table>	Code	Description	SC201	5 x 30mm																
Code																									
GE539																									
Code	Description																								
SC201	5 x 30mm																								
	<p>Outlet 76mmØ Downpipe connection</p> <table border="1"> <tr> <td>Code</td> <td>A</td> <td>B</td> <td>C</td> <td>Fascia to outlet centre</td> </tr> <tr> <td>GE523</td> <td>214</td> <td>150</td> <td>85</td> <td>70</td> </tr> </table>	Code	A	B	C	Fascia to outlet centre	GE523	214	150	85	70		<p>Joint sealant 310ml tube, clear. All joints must be sealed using Alutec's SC101. Sealant usage table on page 44</p> <table border="1"> <tr> <td>Code</td> </tr> <tr> <td>SC101</td> </tr> </table>	Code	SC101										
Code	A	B	C	Fascia to outlet centre																					
GE523	214	150	85	70																					
Code																									
SC101																									



These products are compatible with all 76mmØ and 72x72mm downpipes



For delivery charges and lead times see page 90



See page 6 for details of our standard colours
Please state colour when ordering

Gutter 3m

Code	A	B
GB513	130	85

Outlet
72x72mm

Code	A	B	C	Fascia to outlet centre
GB525	200	133	80	76

Union

Code	A
GB520	72

Outlet spigot extender
for fascia depths greater than 260mm

Description
76mm Ø
72x72mm

Fascia bracket
Fix at 1m centres

Code	A	B	C	D
GB580	138	83	57	38

Stop end
(internal)

Code	A
GB550	35

Angle 90°

Code	A	B
GB532	138	35

Stop end
(external)

Code	A
GB555	37

Angle 135°

Code	A	B
GB537	55	35

Leafguard
Mill finish

Code	A
SL76	1220

Non standard angle

Angle TBC when ordering

Code
GB539

Compatible fixing screws
Roundhead fascia bracket screw. Mill finish

Code	Description
SC201	5 x 30mm

Outlet
(76mm Ø)

Code	A	B	C	Fascia to outlet centre
GB523	200	133	80	76

Joint sealant
310ml tube, clear.
All joints must be sealed using Alutec's SC101.
Sealant usage table on page 44

Code
SC101



These products are compatible with all 76mmØ and 72x72mm downpipes



For delivery charges and lead times see page 90



See page 6 for details of our standard colours
Please state colour when ordering

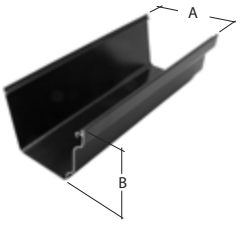

Gutter 3m

Code	A	B
GY513	130	95

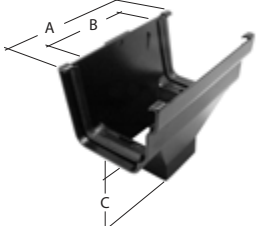

Outlet
(72x72mm)

Code	A	B	C	Fascia to outlet centre
GY525	200	130	69	67

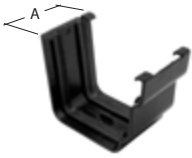

Union

Code	A
GY520	72



Outlet spigot extender
for fascia depths greater than 260mm

Description
76mm Ø
72x72mm

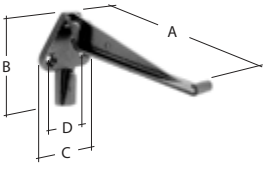

Fascia bracket
Fix at 1m centres

Code	A	B	C	D
GY580	138	83	57	38

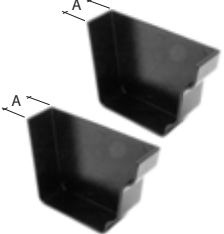

Stop end
(internal)

Code	Description	A
GY558	Right hand	35
GY557	Left hand	35

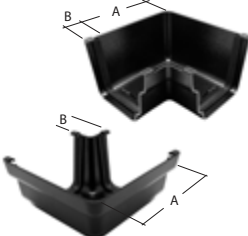

Angle 90°

Code	Description	A	B
GY530	Internal	145	35
GY531	External	35	31



Stop end
(external)

Code	Description	A
GY555	Right hand	37
GY550	Left hand	37



Angle 135°

Code	Description	A	B
GY535	Internal	60	35
GY536	External	35	



Leafguard
Mill finish

Code	A
SL77	1220

Non standard angle

Angle TBC when ordering

Code
GY539



Compatible fixing screws
Roundhead fascia bracket screw. Mill finish

Code	Description
SC201	5 x 30mm

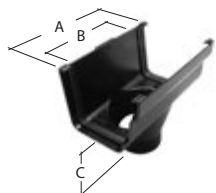

Outlet
(76mm Ø)

Code	A	B	C	Fascia to outlet centre
GY523	200	130	69	69



Joint sealant
310ml tube, clear.
All joints must be sealed using Alutec's SC101.
Sealant usage table on page 44

Code
SC101



Traditional Moulded Ogee



Traditional Half Round



Traditional Victorian Ogee

Using marine grade aluminium for ultimate longevity and low maintenance, three distinct bolted gutter systems manufactured to original British Standard cast iron dimensions BS8530.



Features of the Traditional range

Functional life expectancy of 50 years or more with minimal maintenance, only periodic aesthetic cleaning required

Manufactured to BS 8530:2010, the design standard for Traditional Half Round, Victorian Ogee and Moulded Ogee aluminium rainwater systems

Each profile available in three different sizes

Durable and strong - Manufactured from marine grade aluminium making our Traditional range more corrosion resistant than other grade aluminium systems and cast iron products

Fade resistant architectural grade polyester powder coat paint finish

19 standard colours

65% lighter than equivalent cast iron systems, making it easier and safer to handle and install



St Augustines Church Bermondsey



Shepherd Neame, The Faversham Brewery, Kent



Private House, East Sussex

The Prince's Foundation for Building Community, Dumfries House Estate in Scotland



A private family home in Insch in the Scottish countryside



St John the Baptist Church in Smalley, Derbyshire

These products are compatible with 63mmØ, 76mmØ, 102mmØ, 72x72mm and 102x76mm downpipes



For delivery charges and lead times see page 90



See page 6 for details of our standard colours
Please state colour when ordering

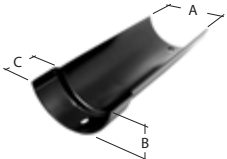

Gutter

Code	Size	Nominal Length (mm)	A	B	C
GC406	100	1.83	105	46	45
GC106	113	1.83	119	51	45
GC506	125	1.83	131	56	45

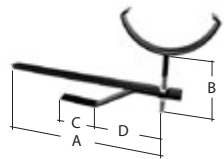

Rise & fall bracket
Fix at 915mm centres

Code	Size	A	B	C	D
AC91	100	360	125	80	168
AC92	113	360	125	80	168
AC93	125	360	125	80	168

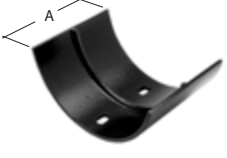

Union
External

Code	Size	A
GC420	100	95
GC120	113	95
GC520	125	95



Leafguard
Mill Finish

Code	Size	A
SL71	100	1220
SL72	113	1220
SL73	125	1220

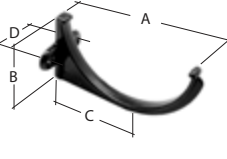

Fascia bracket
Fix at 915mm centres

Code	Size	A	B	C	D
GC480	100	112	62	59	38
GC180	113	126	68	66	38
GC580	125	139	74	72	38



Compatible fixing screws
Roundhead fascia bracket screw. Mill finish

Code	Description
SC201	5 x 30mm

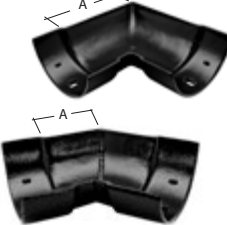

Angle

Code	Size	Angle	A
GC432	100	90°	124
GC437	100	135°	59
GC439	100	Non standard	
GC132	113	90°	137
GC137	113	135°	63
GC139	113	Non standard	
GC532	125	90°	139
GC537	125	135°	55
GC539	125	Non standard	



Aluminium nuts, bolts and washers
For jointing gutters & fittings

Code	Description
SC501	M6 x20mm aluminium bolt PPC Pack 25
SC531	M6 Aluminium nut & washer set Pack 100 - Mill finish

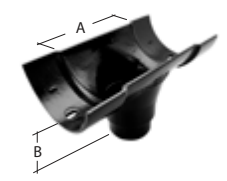

Outlet

Code	Size	Outlet Size	A	B	Fascia to Outlet Centre
GC422	100	63Ø	134	80	61
GC423	100	76Ø	134	42	61
GC425	100	72x72	134	88	61
GC122	113	63Ø	132	83	67
GC123	113	76Ø	132	47	67
GC125	113	72x72	134	88	67
GC522	125	63Ø	133	98	73
GC523	125	76Ø	133	68	73
GC524	125	102Ø	133	36	73
GC525	125	72x72	134	88	73
GC526	125	102x76	133	103	73



Joint sealant
310ml tube, clear
All joints must be sealed using Alutec's SC101.
Sealant usage table on page 44

Code
SC101

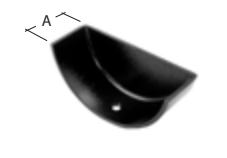

Stop end

Code	Size	Description	A
GC450	100	Internal	45
GC455	100	External	45
GC150	113	Internal	45
GC155	113	External	52
GC550	125	Internal	52
GC555	125	External	50

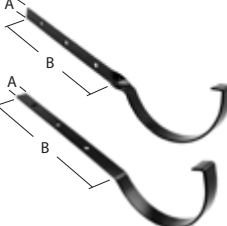

Fixed rafter arm
Fix at 915mm centres

Code	Size	Description	A	B
AC71	100	Side	20	240
AC72	113	Side	20	240
AC73	125	Side	20	240
AC74	100	Top	20	240
AC75	113	Top	20	240
AC76	125	Top	20	240



These products are compatible with 63mmØ, 76mmØ, 72x72mm and 102x76mm downpipes



For delivery charges and lead times see page 90



See page 6 for details of our standard colours
Please state colour when ordering



Gutter

Code	Size	Nominal Length (m)	A	B	C
GV406	100	1.83	109	54	45
GV106	113	1.83	121	61	45
GV506	125	1.83	134	68	45

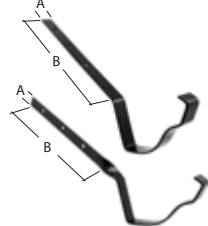

Fixed rafter arm
Fix at 915mm centres

Code	Size	Description	A	B
AV71	100	Side	20	240
AV72	113	Side	20	240
AV73	125	Side	20	240
AV74	100	Top	20	240
AV75	113	Top	20	240
AV76	125	Top	20	240

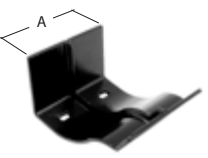

Union
External

Code	Size	A
GV420	100	96
GV120	113	96
GV520	125	96

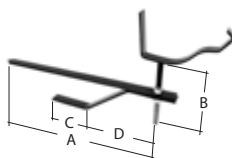

Rise & fall bracket
Fix at 915mm centres

Code	Size	A	B	C	D
AV91	100	360	125	80	168
AV92	113	360	125	80	168
AV93	125	360	125	80	168

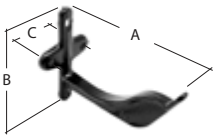

Fascia bracket
Fix at 915mm centres

Code	Size	A	B	C
GV480	100	115	97	38
GV180	113	130	97	38
GV580	125	150	105	45

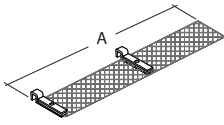

Leafguard
Mill Finish

Code	Size	A
SL111	100	1220
SL113	113	1220
SL125	125	1220

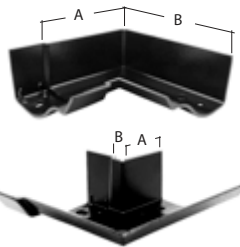

Angle
90° Internal angle 100mm illustrated
90° External angle 100mm illustrated

Code	Size	Angle	A	B
GV430	100	90° Int.	125	176
GV431	100	90° Ext.	68	16
GV435	100	135° Int.	60	114
GV436	100	135° Ext.	75	16
GV439	100	Non standard	-	-
GV130	113	90° Int.	134	186
GV131	113	90° Ext.	63	14
GV135	113	135° Int.	124	67
GV136	113	135° Ext.	70	23
GV139	113	Non standard	-	-
GV530	125	90° Int.	152	212
GV531	125	90° Ext.	77	18
GV535	125	135° Int.	69	125
GV536	125	135° Ext.	64	22
GV539	125	Non standard	-	-



Compatible fixing screws
Mill Finish

Code	Description
SC201	5 x 30mm, roundhead for fascia bracket
SC231	No. 12x50mm, domehead for direct fixing of gutter

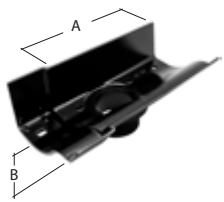

Outlet

Code	Size	Outlet	A	Outlet Centre		B
				Dr/fix	Brkt/fix	
GV422	100	63Ø	195	54	63	27
GV423	100	76Ø	195	54	63	27
GV425	100	72x72	195	54	63	58
GV122	113	63Ø	187	54	63	68
GV123	113	76Ø	187	54	63	68
GV125	113	72x72	187	54	63	31
GV522	125	63Ø	190	54	63	27
GV523	125	76Ø	190	54	63	27
GV525	125	72x72	190	54	63	68
GV526	125	102x76	190	54	63	68



Aluminium nuts, bolts and washers
For jointing gutters & fittings

Code	Description
SC501	M6 x20mm aluminium bolt PPC Pack 25
SC531	M6 Aluminium nut & washer set Pack 100 - Mill finish

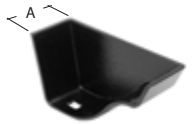

Stop end

Code	Size	Description	A
GV450	100	Left hand (int.)	47
GV455	100	Right hand (ext.)	47
GV150	113	Left hand (int.)	45
GV155	113	Right hand (ext.)	45
GV550	125	Left hand (int.)	45
GV555	125	Right hand (ext.)	45



Joint sealant
310ml tube, clear
All joints must be sealed using Alutec's SC101.
Sealant usage table on page 44

Code
SC101



These products are compatible with 63mmØ, 76mmØ, 102mmØ, 72x72mm, 102x76mm and 102x102mm downpipes



For delivery charges and lead times see page 90



See page 6 for details of our standard colours
Please state colour when ordering

Gutter

Code	Size	Nominal Length (m)	A	B	C
GM406	100	1.83	107	76	60
GM506	125	1.83	139	102	40
GM606	150	1.83	161	102	51

Stop end

Code	Size	Description	A
GM450	100	Left hand (ext.)	47
GM455	100	Right hand (int.)	47
GM550	125	Left hand (ext.)	46
GM555	125	Right hand (int.)	46
GM650	150	Left hand (int.)	47
GM655	150	Right hand (ext.)	47

Union

Internal

Code	Size	A
GM420	100	92
GM520	125	85
GM620	150	90

Fixed rafter arm

Fix at 915mm centres

Code	Size	Description	A	B
AM71	100x75	Side	20	240
AM73	125x100	Side	20	240
AM75	150x100	Side	20	240
AM74	100x75	Top	20	240
AM76	125x100	Top	20	240
AM77	150x100	Top	20	240

Fascia bracket

Fix at 915mm centres

Code	Size	A	B	C	D
GM480	100	117	99	30	38
GM580	125	137	115	38	36
GM680	150	155	121	38	38

Rise & fall bracket

Fix at 915mm centres

Code	Size	A	B	C	D
AM91	100	360	125	80	168
AM93	125	360	125	80	168
AM94	150	360	125	80	168

Direct fix bracket

Fix at 610mm centres

Code	Size	A	B	C
GM481	100	69	24	9
GM581	125	70	34	11
GM681	150	92	35	12

Leafguard

Mill Finish

Code	Size
SL114	100x75
SL115	125x100
SL116	150x100

Angle

90° Internal angle 100mm illustrated
90° External angle 100mm illustrated

Code	Size	Angle	A	B
GM430	100	90° Int.	127	183
GM431	100	90° Ext.	75	19
GM435	100	135° Int.	60	119
GM436	100	135° Ext.	75	18
GM439	100	Non standard	-	-
GM530	125	90° Int.	160	205
GM531	125	90° Ext.	68	23
GM535	125	135° Int.	80	135
GM536	125	135° Ext.	85	27
GM539	125	Non standard	-	-
GM630	150	90° Int.	183	235
GM631	150	90° Ext.	77	24
GM635	150	135° Int.	88	140
GM636	150	135° Ext.	75	24
GM639	150	Non standard	-	-

Compatible fixing screws

Mill finish

Code	Description
SC201	5 x 30mm, roundhead, for fascia bracket
SC231	No. 12x50mm domehead, for direct fixing of gutter

Outlet

Code	Size	Outlet	A	B	Fascia to Outlet Centre
GM422	100	63Ø	192	50	50
GM423	100	76Ø	192	50	64
GM425	100	72x72	192	58	41
GM426	100	102x76	192	58	41
GM522	125	63Ø	190	57	55
GM523	125	76Ø	190	57	55
GM524	125	102Ø	190	57	72
GM525	125	72x72	190	125	65
GM526	125	102x76	190	125	65
GM527	125	102x102	190	56	72
GM622	150	63Ø	190	58	52
GM623	150	76Ø	190	58	67
GM624	150	102Ø	190	58	87
GM625	150	72x72	190	58	42
GM626	150	102x76	190	58	46
GM627	150	102x102	190	58	46

Aluminium nuts, bolts and washers

For jointing gutters & fittings

Code	Description
SC501	M6 x20mm aluminium bolt PPC Pack 25
SC531	M6 Aluminium nut & washer set Pack 100 - Mill finish

Joint sealant

310ml tube, clear
All joints must be sealed using Alutec's SC101.
Sealant usage table on page 44

Code
SC101



The Aligator range offers two distinctive design solutions:

Aligator Classic profile is a domestic size ogee style gutter system with external unions and brackets. The Deepflow, Ogee No.46, Boxer and Giant profiles with internal joints and concealed brackets, offering a sleek and unobtrusive solution for modern building design.

Features of the Aligator® range

Functional life expectancy of 50 years or more with minimal maintenance, only periodic aesthetic cleaning required

Durable and strong - Manufactured from marine grade aluminium making the Aligator range more corrosion resistant than other grade aluminium systems, steel or cast iron products

Patented Aligator Snap-Fit joint system, proven to reduce installation times by up to 40% compared to traditional bolted systems

Fade resistant architectural grade polyester powder coat paint finish

19 standard colours

Sleek and modern solutions developed with the architects in mind



Warren Wood Manor,
private house in Hertfordshire



Ardgartan Hotel,
Scotland



East Sussex Golf Club



Sissinghurst VA Church of England Primary School, Kent



A historic farmhouse in the Dartmoor National Park



A social housing development in Basingstoke



These products are compatible with 63mmØ, 76mm Ø and 72x72mm downpipes



For delivery charges and lead times see page 90



See page 6 for details of our standard colours
Please state colour when ordering

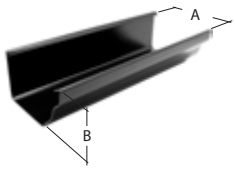

Gutter

Code	Nominal Length (m)	A	B
GK413	3	120	75

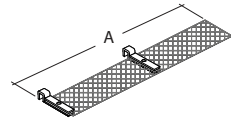

Leafguard
Mill Finish

Code	A
SL101	1220

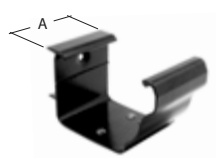

Union
External

Code	A
GK420	75



Compatible fixing screws
Mill finish

Code	Description
SC201	5 x 30mm roundhead - for gutter fascia bracket
SC202	No.10x30mm countersunk - gutter union, angle and outlet screw

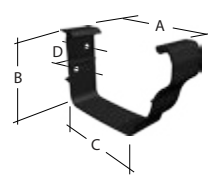

Fascia bracket
Fix at 1m centres

Code	A	B	C	D
GK480	137	82	96	15



Joint sealant
310ml tube, clear
All joints must be sealed using Alutec's SC101.
Sealant usage table on page 44

Code
SC101

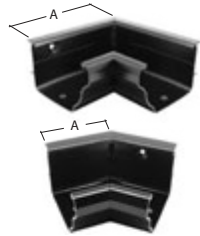

Angle
(internal)

Code	Angle	A
GK430	90°	183
GK435	135°	100
GK439	Non standard	-

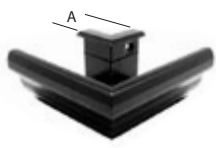

Angle
(external)

Code	Angle	A
GK431	90°	63
GK436	135°	63
GK439	Non standard	-

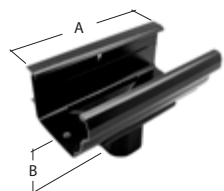

Outlet

Code	Outlet	Fascia to Outlet Centre	A	B
GK421	63Ø	58	200	70
GK423	76Ø	58	200	70
GK425	72x72	56	200	70



Stop end
(external)

Code	Description	A
GK450	Left hand	35
GK455	Right hand	35



These products are compatible with 63mmØ, 76mmØ, 102mmØ, 72x72mm, 102x76mm and 102x102mm downpipes



For delivery charges and lead times see page 90



See page 6 for details of our standard colours
Please state colour when ordering

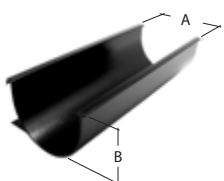

Gutter

Code	Nominal Length (m)	A	B
GD513	3	130	80

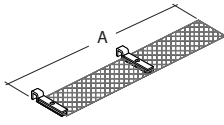

Leafguard
Mill Finish

Code	A
SL102	1220

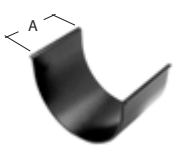

Union
Internal

Code	A
GD520	70



Compatible fixing screws
Roundhead fascia bracket screw. Mill finish

Code	Description
SC201	5 x 30mm - for gutter fascia bracket

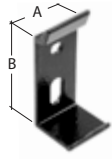

Fascia bracket
For linear alignment of brackets use packing shim, SC380
Fix at 750mm centres

Code	A	B
GD580	25	52



Joint sealant
310ml tube, clear
All joints must be sealed using Alutec's SC101.
Sealant usage table on page 44

Code
SC101

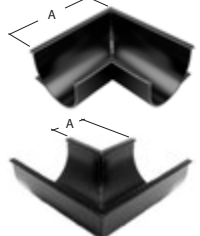

Angle
90° Internal angle illustrated
90° External angle illustrated

Code	Angle	A
GD530	90° internal	200
GD531	90° external	70
GD535	135° internal	120
GD536	135° external	66
GD539	Non standard	-

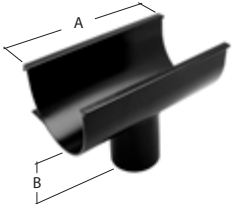

Outlet
63mm Ø outlet illustrated

Code	Outlet Size	A	B	Fascia to Outlet Centre
GD522	63 Ø	200	70	70
GD523	76 Ø	200	70	70
GD524	102 Ø	200	70	70
GD525	72x72	200	70	70
GD526	102x76	200	70	70
GD527	102x102	200	70	70

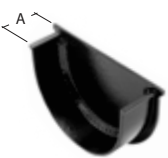

Stop end
Internal

Code	A
GD550	33



Packing shim
For use with GD580 fascia bracket
Mill finish

Code
SC380

These products are compatible with 63mmØ, 76mmØ, 102mmØ, 72x72mm, 102x76mm and 102x102mm downpipes



For delivery charges and lead times see page 90



See page 6 for details of our standard colours
Please state colour when ordering

Gutter

Code	Nominal Length (m)	A	B
GG513	3	155	100

Leafguard
Mill Finish

Code	A
SL103	1220

Union
Internal

Code	A
GG520	70

Compatible fixing screws
Roundhead fascia bracket screw. Mill finish

Code	Description
SC201	5 x 30mm - for gutter fascia bracket

Fascia bracket
For linear alignment of brackets use packing shim, SC381
Fix at 750mm centres

Code	A	B
GG580	30	85

Joint sealant
310ml tube, clear
All joints must be sealed using Alutec's SC101.
Sealant usage table on page 44

Code
SC101

Angle
90° Internal angle illustrated
90° External angle illustrated

Code	Angle	A	B
GG530	90° internal	200	45
GG531	90° external	45	200
GG535	135° internal	135	71
GG536	135° external	71	135
GG539	Non standard	-	-

Outlet

Code	Outlet Size	A	B	Fascia to Outlet Centre
GG522	63 Ø	200	70	73
GG523	76 Ø	200	70	73
GG524	102 Ø	200	70	73
GG525	72x72	200	70	73
GG526	102x76	200	70	73
GG527	102x102	200	70	73

Stop end
Internal

Code	Description	A
GG550	Left hand	33
GG555	Right hand	33

Packing shim
For use with GG580 fascia bracket
Mill finish

Code
SC381

These products are compatible with 63mmØ, 76mmØ, 102mmØ, 72x72mm, 102x76mm and 102x102mm downpipes



For delivery charges and lead times see page 90



See page 6 for details of our standard colours
Please state colour when ordering

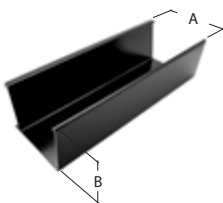

Gutter

Code	Nominal Length (m)	A	B
GF413	3	120	80
GF513	3	135	100
GF613	3	160	100



Packing shim
Mill finish
For use with GF480 and GF080 fascia bracket

Code	Gutter Size
SC382	120x80
SC381	135x100
	160x100

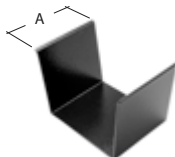

Union
Internal

Code	Size	A
GF420	120	70
GF520	135	70
GF620	160	70

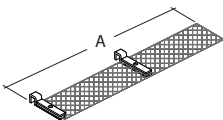

Leafguard
Mill Finish

Code	Gutter Size	A
SL105	120x80	1220
SL106	135x100	1220
SL107	160x100	1220

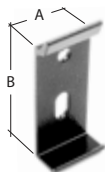

Fascia bracket
[†]Use with 120x80 Gutter
 For linear alignment use shim plate SC382
[‡]Use with 135x100 and 160x100 Gutters
 For linear alignment use shim plate SC381
 Fix at 750mm centres

Code	A	B
GF480 [†]	30	65
GF080 [‡]	30	85



Compatible fixing screws
Roundhead fascia bracket screw. Mill finish

Code	Description
SC201	5 x 30mm - for gutter fascia bracket

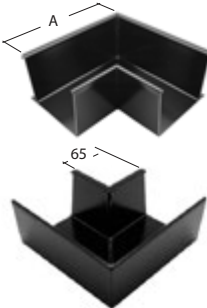

Angle
90° Internal angle illustrated
90° External angle illustrated

Code	Size	Angle	A
GF430	120	90° internal	185
GF431	120	90° external	65
GF435	120	135° internal	115
GF436	120	135° external	65
GF439	120	Non standard	-
GF530	135	90° internal	200
GF531	135	90° external	65
GF535	135	135° internal	120
GF536	135	135° external	64
GF539	135	Non standard	-
GF630	160	90° internal	225
GF631	160	90° external	65
GF635	160	135° internal	135
GF636	160	135° external	69
GF639	160	Non standard	-



Joint sealant
310ml tube, clear
All joints must be sealed using Alutec's SC101.
Sealant usage table on page 44

Code
SC101

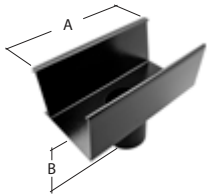

Outlet

Code	Size	Outlet	A	B	Fascia to Outlet Centre
GF422	120	63 Ø	200	70	66
GF423	120	76 Ø	200	70	66
GF425	120	72x72	200	70	66
GF426	120	102x76	200	70	66
GF522	135	63 Ø	200	70	75
GF523	135	76 Ø	200	70	75
GF524	135	102 Ø	200	70	75
GF525	135	72x72	200	70	75
GF526	135	102x76	200	70	75
GF527	135	102x102	200	70	75
GF622	160	63 Ø	200	70	88
GF623	160	76 Ø	200	70	88
GF624	160	102 Ø	200	70	88
GF625	160	72x72	200	70	88
GF626	160	102x76	200	70	88
GF627	160	102x102	200	70	88

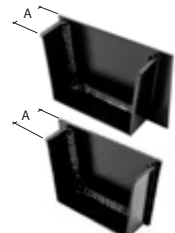

Stop end
Internal

Code	Size	Description	A
GF450	120	Left hand	33
GF455	120	Right hand	33
GF550	135	Left hand	33
GF555	135	Right hand	33
GF650	160	Left hand	33
GF655	160	Right hand	33

These are compatible with 76mmØ, 102mmØ, 72x72mm, 102x76mm and 102x102mm downpipes



For delivery charges and lead times see page 90



See page 6 for details of our standard colours
Please state colour when ordering

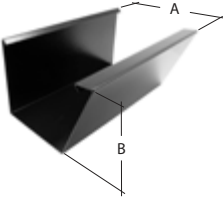

Gutter

Code	Nominal Length (m)	A	B
GH813	3	200	150



Compatible fixing screws
Mill finish

Code	Description
SC202	No.10x30mm countersunk - gutter union, angle and outlet screw
SC231	50mm x No.12 x 50mm, domehead for use with stiffener bracket GH885

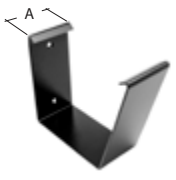

Union
External

Code	A
GH820	70



Aluminium washer
Pack of 100qty
Mill finish

Code	Description
SC521	M6 x 20mm aluminium washer set

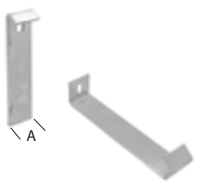

Stiffener bracket & spacer assembly
4 stiffener brackets and spacers required to each 3m gutter length
Mill finish
Fix at 750mm centres

Code	A
GH885	25



Joint sealant
310ml tube, clear
All joints must be sealed using Alutec's SC101.
Sealant usage table on page 44

Code
SC101

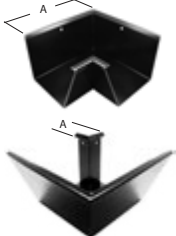

Angle
90° Internal angle illustrated
90° External angle illustrated

Code	Angle	A
GH830	90° internal	250
GH831	90° external	50
GH835	135° internal	150
GH836	135° external	67
GH839	Non standard	-

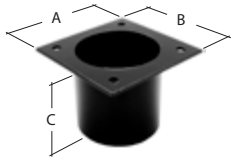

Patch outlet
Includes fixing bolts and nuts. All joints must be sealed using Alutec Joint sealant SC101.

Code	Outlet Size	A	B	C
GH823	76 Ø	100	100	70
GH824	102 Ø	128	128	70
GH825	72x72	120	120	70
GH826	102x76	160	120	70
GH827	102x102	140	140	70



Stop end
External





Code	Description	A
GH850	Left hand	33
GH855	Right hand	33





Leafguard
Mill Finish

Code	A
SL225	1220

Gutter flow rates







Gutter Profile	Downpipe Size	End Outlet		Centre Outlet	
		Capacity l/s	Effective Roof Area m ²	Capacity l/s	Effective Roof Area m ²
Half Round 123x51mm 	63mm Ø	0.85	41	1.8	87
Deepflow 128x75mm 	76mm Ø	2.5	120	4.9	232
Box 130x85mm 	76mm Ø	3.0	142	6.0	286
	72x72mm	3.5	167	7.0	333
Ogee 130x95mm 	76mm Ø	3.0	142	6.0	286
	72x72mm	3.5	167	7.0	333

Gutter flow rates

Gutter Profile	Downpipe Size	End Outlet		Centre Outlet	
		Capacity l/s	Effective Roof Area m ²	Capacity l/s	Effective Roof Area m ²
100mm Half Round	63mmØ, 76mmØ, 72x72mm	0.70	33	1.40	66
113mm 	63mmØ, 76mmØ, 72x72mm	0.85	40	1.70	80
125mm	63mmØ, 76mmØ, 102mmØ, 72x72mm, 102x76mm	1.27	60	2.54	120
100mm Victorian Ogee	63mmØ, 76mmØ, 72x72mm	0.54	25	1.08	51
113mm 	63mm Ø	0.62	29	1.20	57
	76mm Ø, 72x72mm	0.62	29	1.24	59
	63mm Ø	0.75	35	1.60	76
	76mm Ø, 72x72mm, 102x76mm	0.80	38	1.70	80
100mm Moulded Ogee	63mmØ, 76mmØ, 72x72mm, 102x76mm	1.15	55	2.25	108
125mm 	63mm Ø	2.21	105	3.77	179
	76mm Ø	2.21	105	3.77	179
	102mm Ø	2.21	105	4.48	213
	72x72mm	2.21	105	3.53	168
	102x76mm	2.21	105	4.49	213
	102x102mm	2.21	105	4.51	214
	150mm	63mm Ø	2.75	131	4.90
150mm	76mm Ø	2.75	131	4.90	236
	102mm Ø	2.75	131	5.50	263
	72x72mm	2.75	131	3.60	174
	102x76mm	2.75	131	5.47	263
	102x102mm	2.75	131	5.47	263

Gutter Flow Capacity

Gutter flow rates

Gutter Profile	Downpipe Size	End Outlet		Centre Outlet	
		Capacity l/s	Effective Roof Area m ²	Capacity l/s	Effective Roof Area m ²
Aligator® Classic 120x75mm 	63mm Ø	2.15	102	4.13	196
	76mm Ø	2.15	102	4.13	196
	72x72mm	2.15	102	4.13	196
Aligator® Deepflow 130x80mm 	63mm Ø, 76mm Ø	2.10	100	4.00	190
	102mm Ø, 72x72mm	2.20	104	4.20	200
	102x76mm	2.20	104	4.20	200
	102x102mm	2.30	109	4.40	209
Aligator® Ogee No. 46 155x100mm 	63mm Ø	3.50	166	5.90	280
	76mm Ø	3.80	180	5.90	280
	102mm Ø	4.00	190	7.60	361
	72x72mm, 102x76mm	3.90	185	7.50	357
	102x102mm	4.10	195	7.60	361
Aligator® Boxer 120x80mm 	63mm Ø	2.27	108	3.39	161
	76mm Ø	2.27	108	3.75	178
	72x72mm	2.27	108	4.26	202
	102x76mm	2.27	108	4.34	206
Aligator® Boxer 135x100mm 	63mm Ø	4.17	198	4.17	198
	76mm Ø	4.38	208	5.92	281
	102mm Ø	4.38	208	5.97	284
	72x72mm	4.38	208	6.49	309
	102x76mm	4.38	208	7.09	337
Aligator® Boxer 160x100mm 	102x102mm	4.38	208	7.14	340
	63mm Ø	4.22	200	4.22	200
	76mm Ø	5.25	249	6.06	288
	102mm Ø	5.25	249	6.11	290
	72x72mm	5.25	249	6.68	318
	102x76mm	5.25	249	7.35	350
Aligator® Giant 200x150mm 	102x102mm	5.25	249	7.41	352
	76mm Ø	7.84	373	8.67	412
	102mm Ø	7.91	376	8.75	416
	72x72mm	7.92	377	9.59	456
	102x76mm	7.92	377	10.60	504
	102x102mm	7.92	377	10.76	512



Downpipes

To view compatible gutter systems, see page 7



For delivery charges and lead times see page 90



See page 6 for details of our standard colours
Please state colour when ordering

Downpipe
Non socketed pipe

Code	A
RT213	3000

Pipe clip

Code	A	B	C
RT280	94	118	59

Pipe socket
(eared)

Code	A	B	C	D	E
RT220	82	52	94	116	59

Rainwater diverter

Code	A	B	C	D
TRD25	134	500	74	30

Pipe socket
(non eared)

Code	A	B
RT220NE	82	52

Compatible fixing screws

Code	Description
SC205	No.12 x 50mm domehead screw for downpipe
SC208	M6 x 70mm hexagonal coach screw for hopper

Bend

Code	Description	A	B	C
RT232	Top 112.5°	50	35	46
RT292	Bottom 112.5°	40	64	40
RT230	92.5°	37	27	46

Joint sealant
310ml tube, clear
All joints must be sealed using Alutec's SC101.
Sealant usage table on page 44

Code
SC101

Branch 112.5°

Code	A	B	C
RT242	95	26	115

Shoe

Code	A	B
RT250	92	104

Access pipe

Code	A	B	C
RT260	300	140	105



To view compatible gutter systems, see page 7



For delivery charges and lead times see page 90



See page 6 for details of our standard colours
Please state colour when ordering

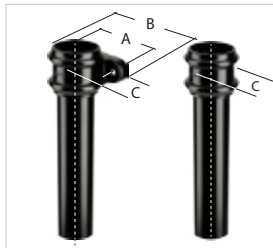

Downpipe

Code	Size	Nominal Length (m)	A	B	C
TR212	63	2	110	145	45
TR212NE	63	2	-	-	45
TR213	63	3	110	145	45
TR213NE	63	3	-	-	45
TR312	76	2	115	160	52
TR312NE	76	2	-	-	52
TR313	76	3	115	160	52
TR313NE	76	3	-	-	52
TR412	102	2	141	186	65
TR412NE	102	2	-	-	65
TR413	102	3	141	186	65
TR413NE	102	3	-	-	65

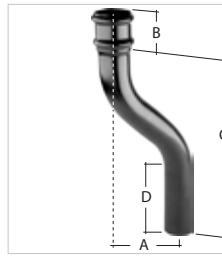

Fixed offset

Code	Size	A	B	C	D
TR2903	63	75	70	370	100
TR2904	63	100	70	355	100
TR2906	63	150	70	400	100
TR3903	76	75	70	380	130
TR3904	76	100	70	380	130
TR3906	76	150	70	400	130
TR4903	102	75	94	512	150
TR4904	102	100	94	516	150
TR4906	102	150	94	566	150

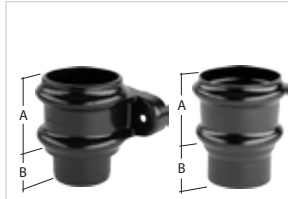

Pipe socket

Code	Size	A	B	Description
TR220	63	75	30	eared
TR220NE	63	75	30	non eared
TR320	76	81	30	eared
TR320NE	76	81	30	non eared
TR420	102	94	30	eared
TR420NE	102	94	50	non eared

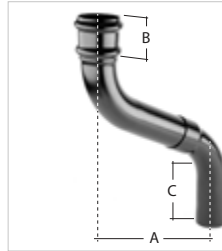

Adjustable offset

Code	Size	A min	A max	B	C
TR2945	63	150	450	70	100
TR2990	63	150	900	70	100
TR3945	76	200	450	70	163
TR3990	76	200	900	70	163
TR4945	102	280	450	94	150
TR4990	102	280	900	94	150

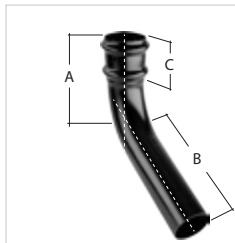

Bend

Code	Size	Angle	A	B	C
TR230	63	92.5°	150	240	70
TR232	63	112.5°	190	230	70
TR330	76	92.5°	180	250	70
TR332	76	112.5°	220	250	70
TR430	102	92.5°	290	325	94
TR432	102	112.5°	230	270	94

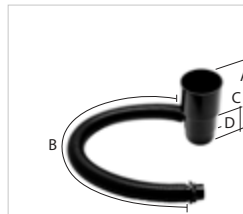

Rainwater diverter

Code	Size	A	B	C	D
TRD25	63	134	500	74	30
TRD35	76	134	500	74	30

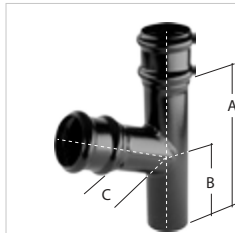

Branch

Code	Size	Angle	A	B	C
TR240	63	92.5°	215	138	75
TR242	63	112.5°	215	138	75
TR340	76	92.5°	250	138	70
TR342	76	112.5°	250	119	90
TR440	102	92.5°	260	150	110
TR442	102	112.5°	260	130	130



Compatible fixings

Code	Description
SC208	M6 x 70mm hexagonal coach screw - for downpipe and hopper
SC209	M6 x 100mm hexagonal coach screw - for wall spacer

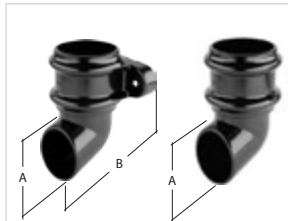

Shoe

Code	Size	Angle	A	B
TR250	63	112.5°	85	90
TR250NE	63	non eared	85	-
TR350	76	112.5°	103	106
TR350NE	76	non eared	103	-
TR450	102	112.5°	125	131
TR450NE	102	non eared	125	-



Wall spacer

30mm projection

Code	Description
SC712	Pack of 2

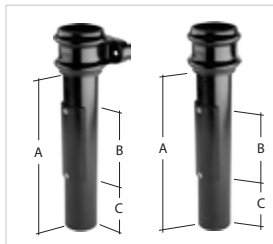

Access pipe

Code	Size	A	B	C
TR260	63	300	140	105
TR260NE	63	300	140	105
TR360	76	300	140	105
TR360NE	76	300	140	105
TR460	102	300	140	105
TR460NE	102	300	140	105



Joint sealant

310ml tube, clear
All joints must be sealed using Alutec's SC101.
Sealant usage table on page 44

Code	Description
SC101	



Pipe clip

Code	Size	A	B	C
TR280	63	117.5	93.5	45
TR380	76	136	111	52
TR480	102	168	143	65



Flushfit Circular Downpipe

To view compatible gutter systems, see page 7



For delivery charges and lead times see page 90



See page 6 for details of our standard colours
Please state colour when ordering

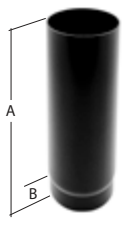

Downpipe
3m

Code	Size	A	B
RE213	63	3000	30
RE313	76	3000	30
RE413	102	3000	50

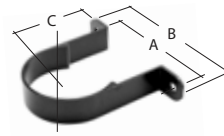

Pipe clip

Code	Size	A	B	C
RE280	63	94	118	59
RE380	76	112	137	69
RE480	102	110	140	91



Internal joint spigot

Code	Size	A
RE220	63	64
RE320	76	69
RE420	102	104

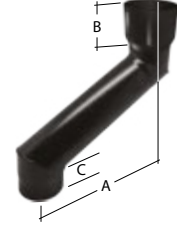

Adjustable eaves offset

Code	Size	A min	A max	B	C
RE2925	63	90	250	50	30
RE2950	63	90	500	50	30
RE29100	63	90	1000	50	30
RE3925	76	90	250	50	30
RE3950	76	90	500	50	30
RE39100	76	90	1000	50	30
RE4925	102	90	250	64	50
RE4950	102	90	500	64	50
RE49100	102	90	1000	64	50



Socket to spigot connector
For connecting straight pipe directly to gutter outlets

Code	Size	A
RE224	63	50
RE324	76	50
RE424	102	64

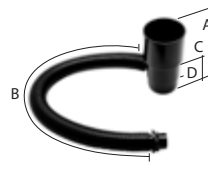

Rainwater diverter

Code	Size	A	B	C	D
TRD25	63	125	500	45	25
TRD35	76	125	500	45	25

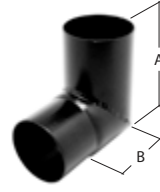

Bend

Code	Size	Angle	A	B
RE230	63	92.5°	115	51
RE232	63	112.5°	90	56
RE330	76	92.5°	115	51
RE332	76	112.5°	90	56
RE430	102	92.5°	160	106
RE432	102	112.5°	130	76



Compatible fixing screws

Code	Description
SC208	M6 x 70mm hexagonal coach screws - for downpipe and hopper

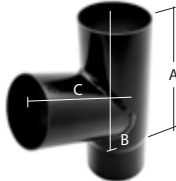

Branch 112.5°

Code	Size	A	B	C
RE242	63	176	65	107
RE342	76	180	180	120
RE442	102	310	150	196



Joint sealant
310ml tube, clear
All joints must be sealed using Alutec's SC101.
Sealant usage table on page 44

Code
SC101



Shoe

Code	Size	A	B
RE250	63	167	58
RE350	76	173	62
RE450	102	203	75

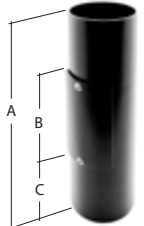

Access pipe

Code	Size	A	B	C
RE260	63	345	140	105
RE360	76	345	138	104
RE460	102	345	140	105



To view compatible gutter systems, see page 7



For delivery charges and lead times see page 90



See page 6 for details of our standard colours
Please state colour when ordering

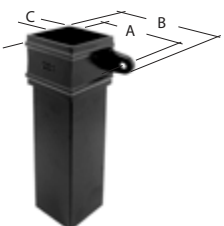

Downpipe

Code	Size	Nominal Length (m)	A	B	C
RSR313	72x72	3	125	151	42
RSR313NE	72x72	3	-	-	42
RSR113	102x76	3	154	182	44
RSR113NE	102x76	3	-	-	44
RSR413	102x102	3	154	182	56
RSR413NE	102x102	3	-	-	56

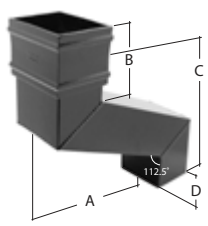

Fixed offset
For 102x76mm size, add suffix R or L to product code if right or left hand projection is required

Code	Size	A	B	C	D
RSR3903	72x72	75	80	160	60
RSR3904	72x72	100	80	173	60
RSR3906	72x72	150	80	193	60
RSR1903	102x76	75	82	160	60
RSR1904	102x76	100	82	175	60
RSR1906	102x76	150	82	185	60
RSR4903	102x102	75	82	180	60
RSR4904	102x102	100	82	188	60
RSR4906	102x102	150	82	220	60

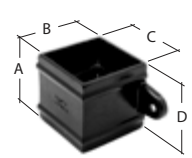

Pipe socket

Code	Size	A	B	C	D
RSR320	72x72	80	83	83	40
RSR320NE	72x72x	80	83	83	40
RSR120	102x76	80	87	112	40
RSR120NE	102x76	80	87	112	40
RSR420	102x102	80	112	112	40
RSR420NE	102x102	80	112	112	40

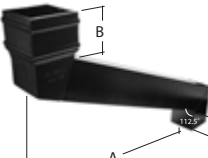

Adjustable offset
For 102x76mm size, add suffix R or L to product code if right or left hand projection is required

Code	Size	A min	A max	B	C
RSR3945	72x72	75	450	82	60
RSR3990	72x72	75	900	82	60
RSR1945	102x76	75	450	82	60
RSR1990	102x76	75	900	82	60
RSR4945	102x102	100	450	82	60
RSR4990	102x102	100	900	82	60

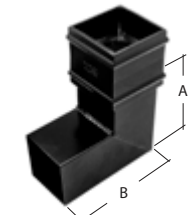

Bend
For 102x76mm size, add suffix R or L to product code if right or left hand projection is required

Code	Size	Angle	A	B
RSR330	72x72	92.5°	150	150
RSR332	72x72	112.5°	60	135
RSR335	72x72	135°	43	110
RSR130	102x76	92.5°	175	175
RSR132	102x76	112.5°	63	140
RSR135	102x76	135°	55	132
RSR430	102x102	92.5°	198	198
RSR432	102x102	112.5°	75	155
RSR435	102x102	135°	55	140

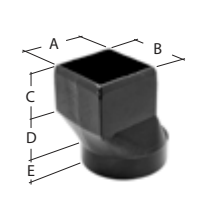

Drain connector
(slip socket)
Adapts to 110mm Ø drain pipe socket

Code	Size	A	B	C	D	E
RSR370	72x72	85	85	65	41	30
RSR170	102x76	90	116	65	41	30
RSR470	102x102	115	115	65	41	30

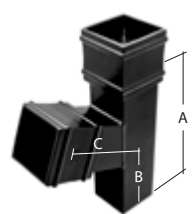

Branch
For 102x76mm size, add suffix R or L to product code if right or left hand projection is required

Code	Size	Angle	A	B	C
RSR340	72x72	92.5°	260	140	114
RSR342	72x72	112.5°	260	127	130
RSR345	72x72	135°	260	95	160
RSR140	102x76	92.5°	280	130	140
RSR142	102x76	112.5°	280	112	156
RSR145	102x76	135°	280	72	164
RSR440	102x102	92.5°	280	130	140
RSR442	102x102	112.5°	280	112	156
RSR445	102x102	135°	280	72	164



Cast spacer bobbin
30mm projection

Code	Description
SC711	For use with downpipe

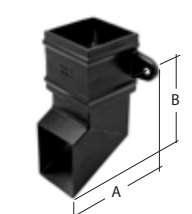

Shoe

Code	Size	Angle	A	B
RSR350	72x72	120°	96	100
RSR350NE	72x72	120°	96	100
RSR150	102x76	120°	108	170
RSR150NE	102x76	120°	108	170
RSR450	102x102	120°	132	198
RSR450NE	102x102	120°	132	198

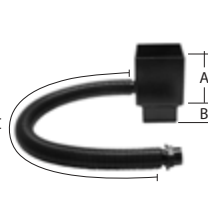

Rainwater diverter

Code	Size	A	B	C
RSRD35	72x72	98	30	500
RSRD15	102x76	98	30	500

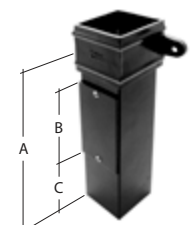

Access pipe

Code	Size	A	B	C
RSR360	72x72	300	140	105
RSR360NE	72x72	300	140	105
RSR160	102x76	300	140	105
RSR160NE	102x76	300	140	105
RSR460	102x102	300	140	105
RSR460NE	102x102	300	140	105



Compatible fixing screws

Code	Description
SC208	M6 x 70mm hexagonal coach screw - for downpipe and hopper
SC209	M6 x 100mm hexagonal coach screw - for cast spacer bobbin

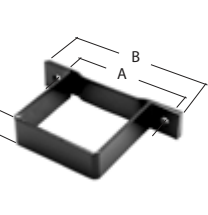

Pipe clip

Code	Size	A	B	C
RSR380	72x72mm	103	128	25
RSR180	102x76	134	159	25
RSR480	102x102	134	159	25



Joint sealant
310ml tube, clear
All joints must be sealed using Alutec's SC101.
Sealant usage table on page 44

Code
SC101

Flushfit Square & Rectangular Downpipe

To view compatible gutter systems, see page 7



For delivery charges and lead times see page 90



See page 6 for details of our standard colours
Please state colour when ordering

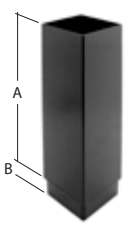

Downpipe
3m

Code	Size	A	B
RJ313	72x72	3000	30
RJ113	102x76	3000	34
RJ413	102x102	3000	34

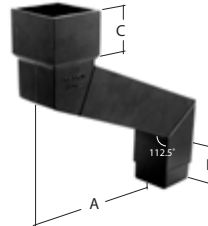

Adjustable eaves offset

Code	Size	A min	A max	B	C
RJ3925	72x72	75	250	75	60
RJ3950	72x72	75	500	75	60
RJ39100	72x72	75	1000	75	60
RJ1925	102x76	75	250	83	60
RJ1950	102x76	75	500	83	60
RJ19100	102x76	75	1000	83	60
RJ4925	102x102	75	250	83	60
RJ4950	102x102	75	500	83	60
RJ49100	102x102	75	1000	83	60

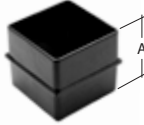

Internal joint spigot

Code	Size	A
RJ320	72x72	62
RJ120	102x76	70
RJ420	102x102	70

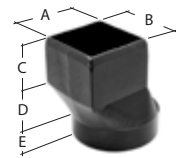

Drain connector
(Slip socket)
Adapts to 110mm Ø drain pipe socket

Code	Size	A	B	C	D	E
RSR370	72x72	85	85	65	41	30
RSR170	102x76	90	116	65	41	30
RSR470	102x102	115	115	65	41	30

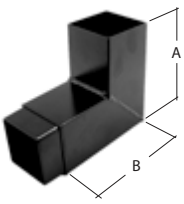

Bend

Code	Size	Angle	A	B
RJ330	72x72	92.5°	150	150
RJ332	72x72	112.5°	128	128
RJ130	102x76	92.5°	175	175
RJ132	102x76	112.5°	150	150
RJ430	102x102	92.5°	198	198
RJ432	102x102	112.5°	154	154

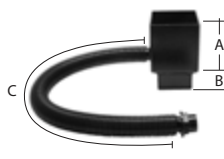

Rainwater diverter

Code	Size	A	B	C
RSRD35	72x72	98	30	500
RSRD15	102x76	98	30	500

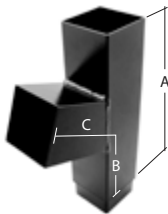

Branch 112.5°

Code	Size	A	B	C
RJ342	72x72	260	127	154
RJ142	102x76	280	112	190
RJ442	102x102	280	112	190



Compatible fixing screws

Code	Description
SC208	M6 x 70mm hexagonal coach screw - for downpipe and hopper



Shoe

Code	Size	A	B
RJ350	72x72	96	160
RJ150	102x76	104	187
RJ450	102x102	130	202



Joint sealant
310ml tube, clear
All joints must be sealed using Alutec's SC101.
Sealant usage table on page 44

Code
SC101

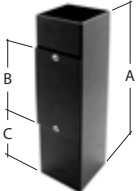

Access pipe

Code	Size	A	B	C
RJ360	72x72	300	140	105
RJ160	102x76	300	140	105
RJ460	102x102	300	140	105

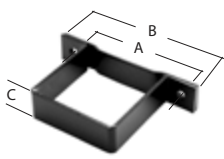

Pipe clip

Code	Size	A	B	C
RJ380	72x72	103	128	25
RJ180	102x76	134	159	25
RJ480	102x102	134	159	25



To view compatible gutter systems, see page 7



For delivery charges and lead times see page 90



See page 6 for details of our standard colours
Please state colour when ordering

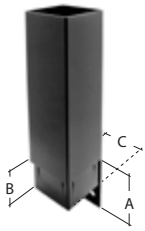

Downpipe

Code	Size	Nominal Length (m)	A	B	C
RVR313	72x72	3	100	50	72
RVR113	102x76	3	100	50	102
RVR413	102x102	3	100	50	102

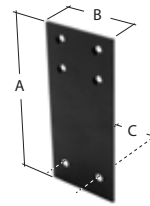

Fixing plate

Supplied complete with fixing kit

Code	Size	A	B	C
RVR380	72x72	150	68	38
RVR180	102x76	150	98	58
RVR480	102x102	150	98	58

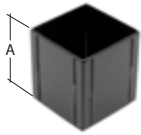

Internal joint spigot

Code	Size	A
RVR320	72x72	70
RVR120	102x76	70
RVR420	102x102	70

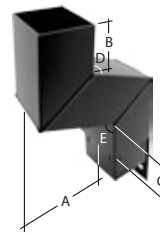

Wall offset

Complete with fixing plate
Provide required dimensions with order

Code	POA

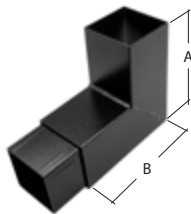

Bend

For gutter outlet connection, use Adjustable eaves offset

Code	Size	Angle	A	B
RVR330	72x72	92.5°	150	150
RVR332	72x72	112.5°	128	128
RVR335	72x72	135°	110	110
RVR130	102x76	92.5°	175	175
RVR132	102x76	112.5°	150	150
RVR135	102x76	135°	132	132
RVR430	102x102	92.5°	198	198
RVR432	102x102	112.5°	154	154
RVR435	102x102	135°	141	141

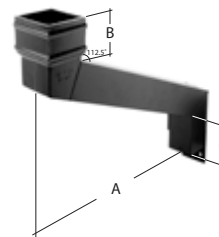

Adjustable eaves offset

Non-standard projections available on request

Code	Size	A min	A max	B	C
RVR3945	72x72	75	450	82	60
RVR3990	72x72	75	900	82	60
RVR1945	102x76	75	450	82	60
RVR1990	102x76	75	900	82	60
RVR4945	102x102	100	450	82	60
RVR4990	102x102	100	900	82	60

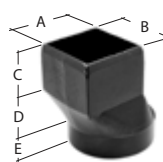

Drain connector

(Slip socket)
Adapts to 110mm Ø drain pipe socket

Code	Size	A	B	C	D	E
RSR370	72x72	85	85	65	41	30
RSR170	102x76	90	116	65	41	30
RSR470	102x102	115	115	65	41	30

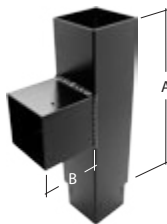

Branch

Code	Size	Angle	A	B
RVR340	72x72	92.5°	260	114
RVR342	72x72	112.5°	260	130
RVR345	72x72	135°	260	160
RVR140	102x76	92.5°	280	140
RVR142	102x76	112.5°	280	156
RVR145	102x76	135°	280	164
RVR440	102x102	92.5°	280	140
RVR442	102x102	112.5°	280	156
RVR445	102x102	135°	280	164



Downpipe fixing plate screw

Description

Code	Description
SC241	No. 12 X 50mm countersunk screw for fixing plate

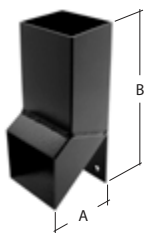

Shoe

Code	Size	A	B
RVR350	72x72	101	270
RVR150	102x76	108	270
RVR450	102x102	140	270



Joint sealant

310ml tube, clear
All joints must be sealed using Alutec's SC101.
Sealant usage table on page 44

Code
SC101

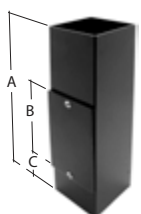

Access pipe

Code	Size	A	B	C
RVR360	72x72	300	140	105
RVR160	102x76	300	140	105
RVR460	102x102	300	140	105



Hopper Heads





For delivery charges and lead times see page 90



See page 6 for details of our standard colours
Please state colour when ordering

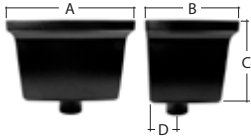

Hopper head
(Standard)

Code	Downpipe system size Ø	A	B	C	D
RH110	Evolve 63	250	180	180	59
TH101	Tudor 63	250	180	180	45
TH102	Tudor 76	250	180	180	52
TH103	Tudor 102	250	180	180	65
RH104	Traditional 72x72	250	180	180	42
RH105	Traditional 102x76	250	180	180	44
RH106	Traditional 102x102	250	180	180	54
RH113	Flushfit 63	250	180	180	59
RH111	Flushfit 76	250	180	180	70
RH114	Flushfit 102	250	180	180	91
RH112	Flushfit 72x72	250	180	180	42
RH115	Flushfit 102x76	250	180	180	44
RH116	Vandal Res. 102x102	250	180	180	57

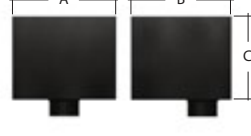

Hopper head
(Contemporary standard)

Code	Downpipe system size Ø	A	B	C
RH610	Evolve 63	250	240	200
TH601	Tudor 63	250	240	200
TH602	Tudor 76	250	240	200
TH603	Tudor 102	250	240	200
RH604	Traditional 72x72	250	240	200
RH605	Traditional 102x76	250	240	200
RH606	Traditional 102x102	250	240	200
RH613	Flushfit 63	250	240	200
RH611	Flushfit 76	250	240	200
RH614	Flushfit 102	250	240	200
RH612	Flushfit 72x72	250	240	200
RH615	Flushfit 102x76	250	240	200
RH616	Flushfit 102x102	250	240	200

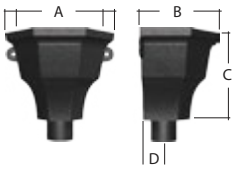

Hopper head
(Fluted)

Code	Downpipe system size Ø	A	B	C	D
TH401	Tudor 63	285	210	225	45
TH402	Tudor 76	285	210	225	52
RH404	Traditional 72x72	285	210	227	42

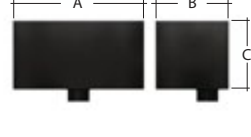

Hopper head
(Contemporary large)

Code	Downpipe system size Ø	A	B	C
RH710	Evolve 63	430	240	225
TH701	Tudor 63	430	240	225
TH702	Tudor 76	430	240	225
TH703	Tudor 102	430	240	225
RH704	Traditional 72x72	430	240	225
RH705	Traditional 102x76	430	240	225
RH706	Traditional 102x102	430	240	225
RH713	Flushfit 63	430	240	225
RH711	Flushfit 76	430	240	225
RH714	Flushfit 102	430	240	225
RH712	Flushfit 72x72	430	240	225
RH715	Flushfit 102x76	430	240	225
RH716	Flushfit 102x102	430	240	225

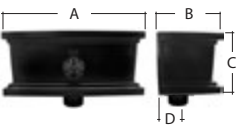

Hopper head
(Ornamental)

Code	Downpipe system size Ø	A	B	C	D
TH301	Tudor 63	410	190	185	45
TH302	Tudor 76	410	190	185	52
TH303	Tudor 102	410	190	185	65
RH304	Traditional 72x72	410	190	185	42
RH305	Traditional 102x76	410	190	185	44
RH306	Traditional 102x102	410	190	185	56

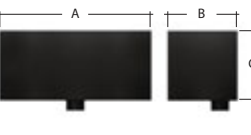

Hopper head
(Contemporary extended)

Code	Downpipe system size Ø	A	B	C
RH810	Evolve 63	600	275	275
TH801	Tudor 63	600	275	275
TH802	Tudor 76	600	275	275
TH803	Tudor 102	600	275	275
RH804	Traditional 72x72	600	275	275
RH805	Traditional 102x76	600	275	275
RH806	Traditional 102x102	600	275	275
RH813	Flushfit 63	600	275	275
RH811	Flushfit 76	600	275	275
RH814	Flushfit 102	600	275	275
RH812	Flushfit 72x72	600	275	275
RH815	Flushfit 102x76	600	275	275
RH816	Flushfit 102x102	600	275	275



Compatible fixing screws

Code	Description
SC208	M6 x 70mm hexagonal coach screw - for downpipe and hopper



Joint sealant
310ml tube, clear
All joints must be sealed using Alutec's SC101.
Sealant usage table on page 44

Code
SC101



FM Mosque, Peterborough

Hopper Heads	Downpipe Size	Capacity, l/s
Standard	63mmØ	3.01
	76mmØ	4.46
	102mmØ	7.94
	72x72mm	4.37
	102x76mm	7.17
	102x102mm	9.49
Fluted	63mmØ	3.01
	76mmØ	4.46
	72x72mm	4.37
Ornamental	63mmØ	3.01
	76mmØ	4.46
	102mmØ	7.94
	72x72mm	4.37
	102x76mm	7.17
	102x102mm	9.49
Contemporary Standard	63mmØ	3.5
	76mmØ	5.1
	102mmØ	9.3
	72x72mm	5.8
	102x76mm	8.6
	102x102mm	11.6

Hopper Heads	Downpipe Size	Capacity, l/s
Contemporary Large	63mmØ	3.8
	76mmØ	5.5
	102mmØ	10
	72x72mm	6.2
	102x76mm	9.3
	102x102mm	12.5
Contemporary Extended	63mmØ	4.3
	76mmØ	6.2
	102mmØ	11.2
	72x72mm	7
	102x76mm	10.5
	102x102mm	14.1

Non-Standard Hoppers

Individually designed hoppers can be fabricated from sheet aluminium and a variety of decorative cast motifs and embellishments can be added to enhance the appearance if required.





Installation Sundries and Sealant Usage Table



For delivery charges and lead times see page 90



See page 6 for details of our standard colours
Please state colour when ordering

	<p>Joint sealant 310ml tube, clear All joints must be sealed using Alutec's SC101.</p> <p>Code SC101</p>		<p>Sealant gun</p> <p>Code SC105</p>
	<p>Solvent cleaner 1 litre</p> <p>Code SC108</p>		<p>Touch up paint 250ml</p> <p>Code SC880</p>

IMPORTANT: ONLY USE ALUTEC SUNDRIES TO ENSURE SYSTEM LIFE EXPECTANCY

Sealant usage table

Approximate number of joints per tube of Alutec sealant



<p>Evolve Half Round 30</p> <p>Evolve Deepflow 30</p> <p>Evolve Box 30</p> <p>Evolve Ogee 30</p> <p>Evolve 63mm Ø pipe 30</p>	<p>Aligator® Classic Ogee 5</p> <p>Aligator® Deepflow 6</p> <p>Aligator® Ogee No. 46..... 4</p> <p>Aligator® Boxer 120x80mm 5</p> <p>Aligator® Boxer 135x100mm 4</p> <p>Aligator® Boxer 160x100mm 4</p> <p>Aligator® Giant 3</p> <p>Tudor 63mm Ø pipe 30</p> <p>Tudor 76mm Ø pipe 30</p> <p>Tudor 102mm Ø pipe 30</p> <p>Traditional 72x72mm pipe 17</p> <p>Traditional 102x76mm pipe 13</p> <p>Traditional 102x102mm pipe 12</p> <p>Flushfit all pipe sizes 30</p> <p>Vandal Resistant all pipe sizes 30</p>
<p>Traditional Half Round 100mm 18</p> <p>Traditional Half Round 113mm 16</p> <p>Traditional Half Round 125mm 14</p> <p>Traditional Victorian Ogee 100mm 14</p> <p>Traditional Victorian Ogee 113mm 12</p> <p>Traditional Victorian Ogee 125mm 11</p> <p>Traditional Moulded Ogee 100mm 11</p> <p>Traditional Moulded Ogee 125mm 9</p> <p>Traditional Moulded Ogee 150mm 7</p>	



Evolve range

Bracket Centres

Gutter brackets must be fixed at maximum of 1m centres.

Jurajoint

Jurajoint is our patented innovative method of joining aluminium gutter, combining the simplicity of a rubber seal with the security of Alutec Sealant. Sealant SC101 is simply applied in one band into the central channel of the rubber seal. When the joint is snapped together it bonds the rubber seal to the gutter surface achieving a durable, thermally flexible and leak free joint.



Aligator range

Bracket Centres

Gutter brackets must be fixed at a maximum of 750mm centres, except Aligator Classic which should be at a maximum of 1m centres.

Snap-Fit

The patented Aligator® Snap-Fit joint system is proven to reduce installation times by up to 40% compared to traditional boited systems. The 'no-bolt' design provides a secure, leak free installation. Each joint is made using four 8mm beads of Alutec sealant.



Traditional range

Bracket Centres

Fascia brackets must be installed at 915mm centres. Direct fix option is only available on Moulded Ogee gutter with fixings at 610mm centres.



Fascia & Soffit Systems

Fascia and Soffit Case Studies



St Michael's primary school in Southfields, London



Housing development for over 55s
in Arbourthorne, Sheffield



A new church hall in
Twentown, Cheddar



For delivery charges and lead times see page 90



See page 6 for details of our standard colours
Please state colour when ordering

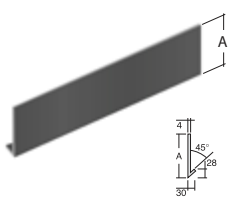

Fascia A - 3m
30mm Return, 45°

Code	A
FA1120	120
FA1165	165
FA1200	200
FA1250	250
FA1325	325
FA1450	450

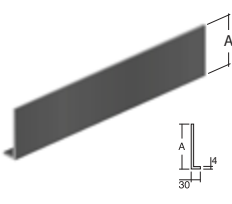

Fascia B - 3m
30mm Return, 90°

Code	A
FB1150	150
FB1175	175
FB1210	210
FB1260	260
FB1335	335
FB1460	460

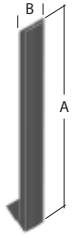

H-Section joint trim
Site cut as required

Code	A	B
FA21	300	31
FA22	500	31

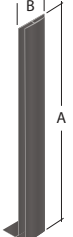

H-Section joint trim
Site cut as required

Code	A	B
FB21	300	31
FB22	500	31

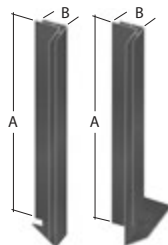

H-Section corner joint trim 90°
Site cut as required

Code	Description	A	B
FA61	External	300	31
FA62	External	500	31
FA71	Internal	300	31
FA72	Internal	500	31

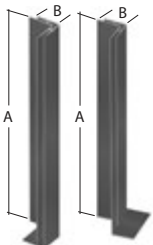

H-Section corner joint trim 90°
Site cut as required

Code		A	B
FB61	External	300	31
FB62	External	500	31
FB71	Internal	300	31
FB72	Internal	500	31

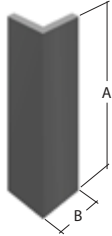

Universal angle cover trim
Site cut and bend as required. Install using rubber roller or equivalent

Code	A	B
FA30	1000	31

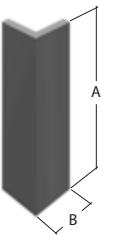

Universal angle cover trim
Site cut and bend as required. Install using rubber roller or equivalent

Code	A	B
FB30	1000	31

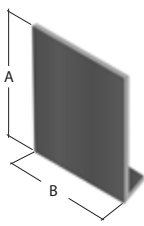

Gable box end
Site cut as required

Code	A	B
FA51	350	450
FA52	350	600
FA53	650	600

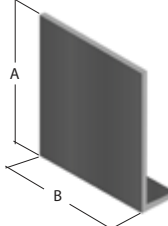

Gable box end
Site cut as required

Code	A	B
FB51	350	450
FB52	350	600
FB53	650	600



Corner gable box end

Code
POA



Corner gable box end

Code
POA



For delivery charges and lead times see page 90



See page 6 for details of our standard colours
Please state colour when ordering

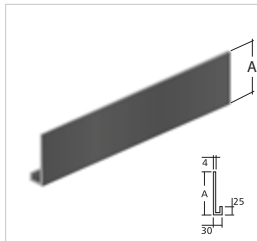

Fascia C - 3m

30x25mm Return

Code	A
FC1150	150
FC1185	185
FC1235	235
FC1310	310
FC1435	435

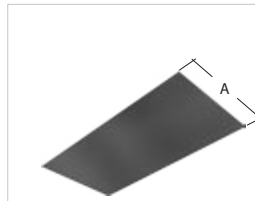

Soffit panel unvented - 3m

Code	A
FF1100	100
FF1180	180
FF1240	240
FF1365	365
FF1490	490
FF1740	740

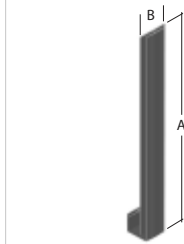

H-Section joint trim

Site cut as required

Code	A	B
FC21	300	31
FC22	500	31

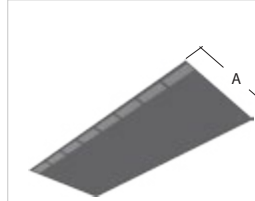

Soffit panel vented - 3m

Slotted to give 25mm continuous ventilation area.

Code	A
FV1100	100
FV1180	180
FV1240	240
FV1365	365
FV1490	490
FV1740	740

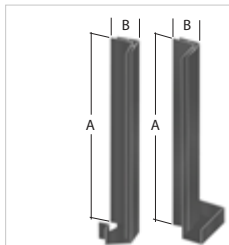

H-Section corner joint trim 90°

Site cut as required

Code		A	B
FC61	External	300	31
FC62	External	500	31
FC71	Internal	300	31
FC72	Internal	500	31

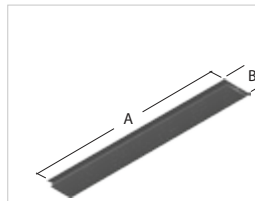

H-Section joint trim

Site cut as required

Code	Description	A	B
FF21	H-Section joint trim	1000	31
FF23	H-Section joint trim	3000	31

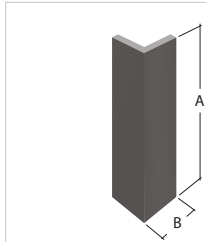

Universal angle cover trim

Site cut and bend as required. Install using rubber roller or equivalent

Code	A	B
FC30	1000	31

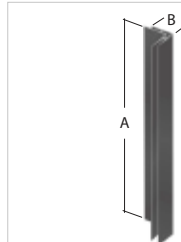

H-Section Corner Joint Trim 90° - 3m

Code	A	B
FF50	3000	31

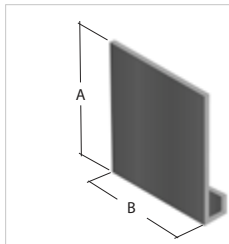

Gable box end

Site cut as required

Code	A	B
FC51	350	450
FC52	350	600
FC53	650	600

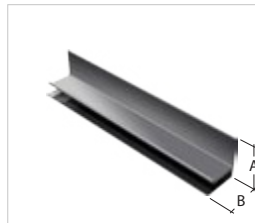

Soffit support trim - 3m

Code	A	B
FF30	30	25



Corner gable box end

Code
POA



For delivery charges and lead times see page 90



See page 6 for details of our standard colours
Please state colour when ordering



Joint sealant

310ml tube, clear
All joints must be sealed using Alutec's SC101.

Code
SC101



Solvent cleaner

1 litre

Code
SC108



Silicone sealant colour matched

For use with Fascia and Soffit Systems only

Code
SC103

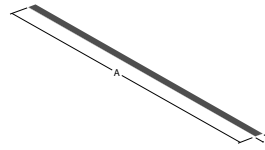

Bonding back plate

70mm x 3m

Code	Description
FY40	For use with Sikatak™ Panel System - Site cut as required Contact Alutec Technical Services department for further details



Compatible pin fixing

Code	Description
SC670	Polypin 2 x 30mm - colour matched (100 per bag)



Compatible pin fixing

Code	Description
SC280	Poly nail 3 x 50mm - colour matched fixing fascia and soffit panels to rafter feet (100 per bag)



Compatible fixing screws

Code	Description
SC675	No. 8x25mm flangehead screw - alternative to polypin fixing (colour matched)

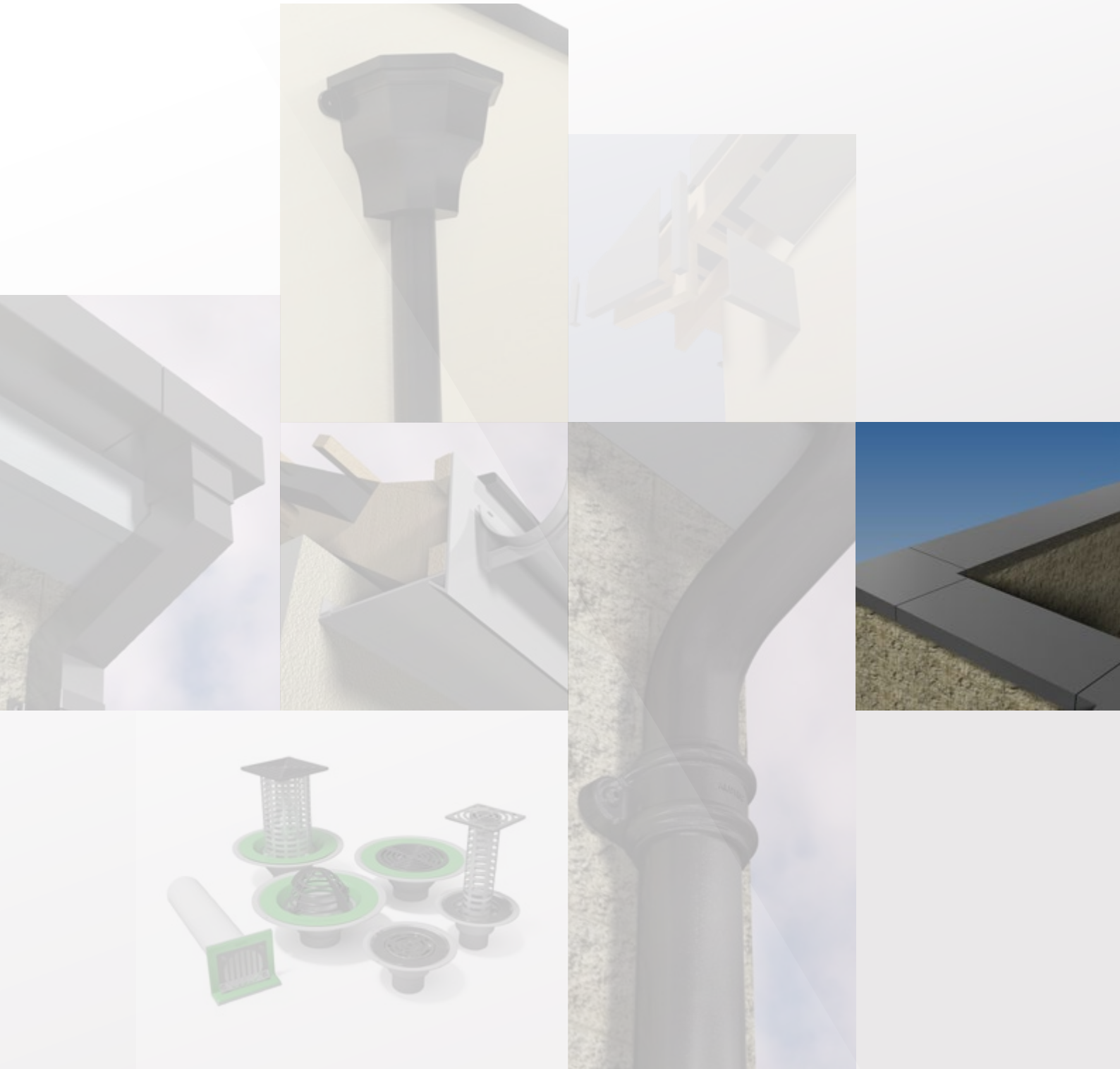

Coping Systems



Magnolia house, support centre at Birmingham Children's Hospital



Joint civil services in Llandrindod Wells



SouthWater visitor centre, Telford



For delivery charges and lead times see page 90



See page 6 for details of our standard colours
Please state colour when ordering

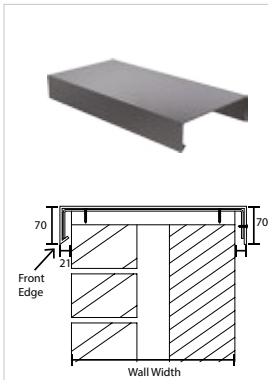

Coping - 3m

Code	Description
CT1160	Coping Length To Fit 100-160mm Wall Width
CT1220	Coping Length To Fit 161-220mm Wall Width
CT1280	Coping Length To Fit 221-280mm Wall Width
CT1340	Coping Length To Fit 281-340mm Wall Width
CT1400	Coping Length To Fit 341-400mm Wall Width
CT1460	Coping Length To Fit 401-460mm Wall Width
CT1520	Coping Length To Fit 461-520mm Wall Width
CT1580	Coping Length To Fit 521-580mm Wall Width
CT1640	Coping Length To Fit 581-640mm Wall Width
CT1700	Coping Length To Fit 641-700mm Wall Width
CT1760	Coping Length To Fit 701-760mm Wall Width
CT1820	Coping Length To Fit 761-820mm Wall Width
CT1880	Coping Length To Fit 821-880mm Wall Width



Stop end upstand - Left hand

Code	Wall Width Ranges
CT7160	100-160mm
CT7220	161-220mm
CT7280	221-280mm
CT7340	281-340mm
CT7400	341-400mm
CT7460	401-460mm
CT7520	461-520mm
CT7580	521-580mm
CT7640	581-640mm
CT7700	641-700mm
CT7760	701-760mm
CT7820	761-820mm
CT7880	821-880mm



Angle 90° External

Code	Wall Width Ranges
CT2160	100-160mm
CT2220	161-220mm
CT2280	221-280mm
CT2340	281-340mm
CT2400	341-400mm
CT2460	401-460mm
CT2520	461-520mm
CT2580	521-580mm
CT2640	581-640mm
CT2700	641-700mm
CT2760	701-760mm
CT2820	761-820mm
CT2880	821-880mm



Stop end upstand - Right hand

Code	Wall Width Ranges
CT8160	100-160mm
CT8220	161-220mm
CT8280	221-280mm
CT8340	281-340mm
CT8400	341-400mm
CT8460	401-460mm
CT8520	461-520mm
CT8580	521-580mm
CT8640	581-640mm
CT8700	641-700mm
CT8760	701-760mm
CT8820	761-820mm
CT8880	821-880mm



Angle 90° Internal

Code	Wall Width Ranges
CT3160	100-160mm
CT3220	161-220mm
CT3280	221-280mm
CT3340	281-340mm
CT3400	341-400mm
CT3460	401-460mm
CT3520	461-520mm
CT3580	521-580mm
CT3640	581-640mm
CT3700	641-700mm
CT3760	701-760mm
CT3820	761-820mm
CT3880	821-880mm



Fixing bracket

Fix at maximum 1.5m centres. Brackets are also used as a jointer to span abutting sections.



Stop end - Left hand

Code	Wall Width Ranges
CT4160	100-160mm
CT4220	161-220mm
CT4280	221-280mm
CT4340	281-340mm
CT4400	341-400mm
CT4460	401-460mm
CT4520	461-520mm
CT4580	521-580mm
CT4640	581-640mm
CT4700	641-700mm
CT4760	701-760mm
CT4820	761-820mm
CT4880	821-880mm



Corner Angle Half Fixing Bracket

Mill finish

Code	Size
CT9070	70



Stop end - Right hand

Code	Wall Width Ranges
CT5160	100-160mm
CT5220	161-220mm
CT5280	221-280mm
CT5340	281-340mm
CT5400	341-400mm
CT5460	401-460mm
CT5520	461-520mm
CT5580	521-580mm
CT5640	581-640mm
CT5700	641-700mm
CT5760	701-760mm
CT5820	761-820mm
CT5880	821-880mm



T-Junction 90°

Code	Wall Width Ranges
CT6160	100-160mm
CT6220	161-220mm
CT6280	221-280mm
CT6340	281-340mm
CT6400	341-400mm
CT6460	401-460mm
CT6520	461-520mm
CT6580	521-580mm
CT6640	581-640mm
CT6700	641-700mm
CT6760	701-760mm
CT6820	761-820mm
CT6880	821-880mm

Compatible fixing screws

Code	Description
SC204	No. 8 x 25mm flangehead screw for use with fixing brackets
SC250	No. 8 x 15mm colour matched flangehead screw for fixing copings to fixing brackets



Marley Alutec has developed a revolutionary range of aluminium roof and balcony drainage outlets compatible with all waterproofing membranes and roof build-ups.

Elite rainwater drainage outlets, together with ancillary components, are suitable for use with bituminous, hot melt, GRP, single ply, asphalt and cold liquid applied membranes to:

- Cold roofs
- Warm roofs
- Inverted roofs
- Green roofs
- Terraces
- Balconies
- Podiums
- Walkways
- Paved areas
- Car parks

Unbeatable drainage flow performance

Elite outlets have been engineered for unbeatable drainage flow performance and in most cases are only restricted by the maximum allowed water capacity of the connecting pipework!

Save on project costs by reducing rainwater pipe requirements

Compared to many conventional outlets, Elite performance figures reduce the number of outlets required to drain an area, thereby reducing the rainwater pipe and underground drainage requirements, offering significant savings.

Optimum watertight seal

Elite outlets membrane compression clamp design, combined with a high-performance butyl sealing ring, securely lock the waterproof membrane to the outlet body ensuring a durable watertight seal.

Sustainable material with 50 year life expectancy

All outlet components are manufactured from marine grade aluminium to give an extensive life expectancy of at least 50 years. Aluminium is well known for its durable characteristics and will never corrode or degrade. Marine grade aluminium, together with the 304 grade stainless steel fixings, ensures compatibility and durability.

Tested to extremes!

Typically, within roof drainage design, the peak rainwater design depth at an outlet will not exceed 35mm. To ensure ultimate reliability and confidence, the Elite outlet range has been rigorously tested to withstand water depths surpassing 1m.

Prevents cold bridging

The Elite range incorporates PVCu pipe connectors, providing an air tight seal and thermal break between the outlet body and connecting pipework.

Connects to all common pipe sizes

Our roof outlet range connects to all common PVCu, HDPE and socketless cast iron pipework sizes.

Balcony outlets connect to aluminium (76mmØ & 72x72mm), PVCu (82mmØ & 110mmØ) and socketless cast iron (70mmØ & 100mmØ) pipework.

Fire protection

The threaded PVCu pipe connectors are manufactured from BS EN 1329 pipework and are therefore suitable for use with pipe wraps and fire collars.



For delivery charges and lead times see page 90

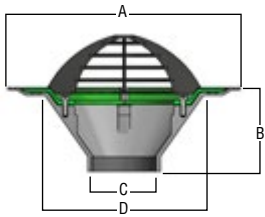

Roof Outlet with Dome Grate

Supplied with PVCu pipe connector

SC101 sealant
Required to seal the supplied PVCu threaded pipe connector to the underside of an outlet.
1 tube seals approx. 10 outlet joints.

Code	Description	A	B	C	D
AR82	Pipe Connection 82mmØ (OD)	377	111	82	255
AR110	Pipe Connection 110mmØ (OD)	377	136	110	255
AR160	Pipe Connection 160mmØ (OD)	377	111	160	255



Roof outlet flat grate

With bolts (2 off)

Code

ARG2

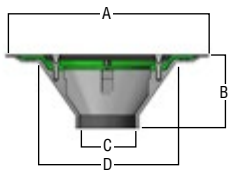

Roof Outlet with Flat Grate

Supplied with PVCu pipe connector

SC101 sealant
Required to seal the supplied PVCu threaded pipe connector to the underside of an outlet.
1 tube seals approx. 10 outlet joints.

Code	Description	A	B	C	D
AR82F	Pipe Connection 82mmØ (OD)	377	111	82	255
AR110F	Pipe Connection 110mmØ (OD)	377	136	110	255
AR160F	Pipe Connection 160mmØ (OD)	377	111	160	255

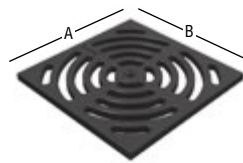

Roof outlet terrace grate

With screw (1 off)

Code

ARTG1

A B

200 200

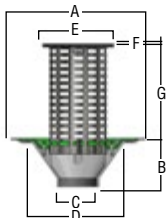

Roof Outlet with Extended Grate 300mm height

Supplied with PVCu pipe connector

SC101 sealant
Required to seal the supplied PVCu threaded pipe connector to the underside of an outlet.
1 tube seals approx. 10 outlet joints.

Code	Description	A	B	C	D	E	F	G
AR82TG	Pipe Connection 82mmØ (OD)	377	111	82	255	200	10	305
AR110TG	Pipe Connection 110mmØ (OD)	377	136	110	255	200	10	305
AR160TG	Pipe Connection 160mmØ (OD)	377	111	160	255	200	10	305



Roof outlet extension piece

Code

ARX1

Description

ARX1 350mm height

ARX1B Extension piece bracket



Bluroof Restriction Device

Fully adjustable to suit project requirements.
Only to be used with Extended Grate Roof Outlets AR82TG, AR110TG and AR160TG.

Code

ARBR



Threaded PVCu pipe connector

For Elite outlets

Code

PTA82

Size

82mmØ

Length

500mm

PTA110

110mmØ

500mm

PTA160

160mmØ

500mm



Refurbishment adaptor

Allows 82mmØ connection outlets to push into 110mmØ outlets

Code

DRH8



Joint sealant

310ml tube, clear

All joints must be sealed using Alutec's SC101.

Code

SC101



Roof outlet clamping ring

Code

ARC1



Roof outlet dome grate

With bolts (2 off)

Code

ARG1



For delivery charges and lead times see page 90

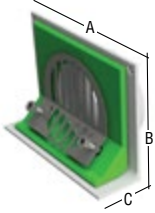

Parapet outlet 110mmØ
Supplied with threaded adaptor

SC101 sealant
Required to seal the supplied PVCu threaded pipe connector to the underside of an outlet.
1 tube seals approx. 10 outlet joints.

Code	A	B	C
AP110L	210	150	60



Balcony outlet flat grate
With screw (3 off)

Code
ABG1



Parapet chute
Designed for use with bituminous, multi-layer and single ply waterproofing membranes

Code	Width
PC300	300x150mm
PC500	500x150mm



Balcony outlet clamping ring

Code
ABC1

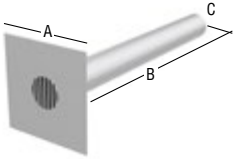

Horizontal parapet overflow outlet

Code	Size	A	B	C
PC063	63mm Ø - 700mm long	210	700	63.5
PC076	76mm Ø - 700mm long	223	700	76.2

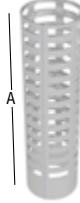

Balcony outlet extension piece

Code	A
ABX1	350



Parapet outlet grate

Code
APG1L

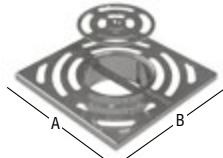

Balcony outlet terrace grate assembly

Code	A	B
ABTG12	150	150



Parapet outlet clamping ring

Code
APC1L



Balcony outlet adaptor with Jubilee clip

Code	Description
ABD12	For connection to 76mmØ and 72x72mm pipe

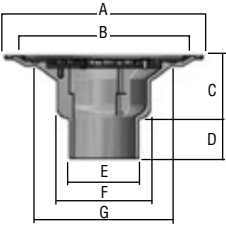

Balcony outlet with flat grate
Connects to 76mmØ, 82mmØ, 110mmØ and 72x72mm pipe

Code	A	B	C	D	E	F	G
ABO1	234	196	77	45	82	110	158

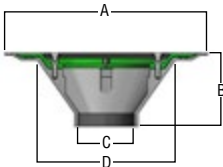

Car park outlet
SC101 sealant
Required to seal the supplied PVCu threaded pipe connector to the underside of an outlet.
1 tube seals approx. 10 outlet joints.

Code	Pipe connection size (O.D)	A	B	C	D
AC82	82mm Ø	377	111	82	255
AC110	110mm Ø	377	136	110	255
AC160	160mm Ø	377	111	160	255

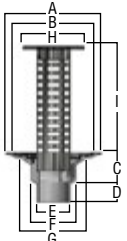

Balcony outlet with terrace grate assembled
Connects to 76mmØ, 82mmØ, 110mmØ and 72x72mm pipe

Code	A	B	C	D	E	F	G	H	I
ABO1TG	234	196	77	45	82	110	158	150	300



Joint sealant
310ml tube, clear
All joints must be sealed using Alutec's SC101.
Sealant usage table on page 44

Code
SC101



For delivery charges and lead times see page 90

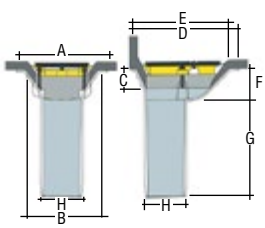

Balcony outlet (Vertical spigot)

Code	Nominal size Ø	Connection size (mm)	A	B	C	D	E	F	G	H
DR360	75	82	230	190	50	265	240	85	260	83
DR460	100	110	230	190	50	265	240	85	260	110



Joint sealant

310ml tube, clear
All joints must be sealed using Alutec's SC101.
Sealant usage table on page 44

Code
SC101

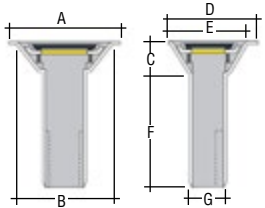

Shallow balcony outlet (Vertical spigot)

Code	Nominal size Ø	Connection size (mm)	A	B	C	D	E	F	G
DR365	75	82	215	172	55	172	152	220	83

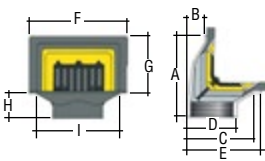

Two-way parapet outlet (Threaded) Threaded adaptor DRA4 sold separately

Code	Nominal size Ø	Connection size (mm)	A	B	C	D	E	F	G	H	J
DR450	100	110	215	50	170	130	193	255	148	70	217



Threaded adaptor

Code	Description
DRA4	500 long



Installation Guides



Installation Guides

- Installation Guides Contents 59
- Evolve Half Round Gutter and 63mmø Downpipe System 60
- Evolve Deepflow Gutter System 62
- Evolve Box and Ogee Gutter Systems 64
- Traditional Gutter Systems 66
- Aligator® Classic Gutter and Downpipe System 68
- Aligator® Deepflow, Ogee 46 & Boxer Gutter System 70
- Aligator® Giant Gutter System 72
- Traditional Top and Side Rafter Arm 74
- Tudor Downpipe System 75
- Traditional Square & Rectangular Downpipe Systems 76
- Flushfit Downpipe Systems 77
- Vandal Resistant Downpipe 78
- Coping Systems 79
- Aluminium Composite Fascia & Soffit Systems 80
- Aluminium Fascia & Soffit Systems 82
- Outlets Typical Applications 84

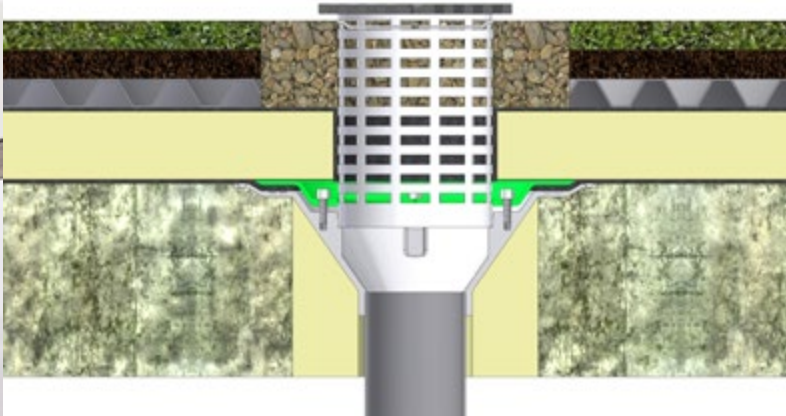



1. Set gutter height by laying a straight batten on the lowest profile of the roof. Place the fascia bracket under the batten so that they are touching and mark the screw holes.



2. Fix fascia brackets with Marley Alutec No. 10 x 32mm roundhead screws, code SC201 or Marley Alutec No. 10 x 15mm countersunk screw, code SC203 if fixing to Marley Alutec aluminium composite fascia. Drilling pilot holes first is recommended.



3. Fix fascia brackets at 1 metre centres. For best flow rate fix to a fall of 1:600 or alternatively nominally level.

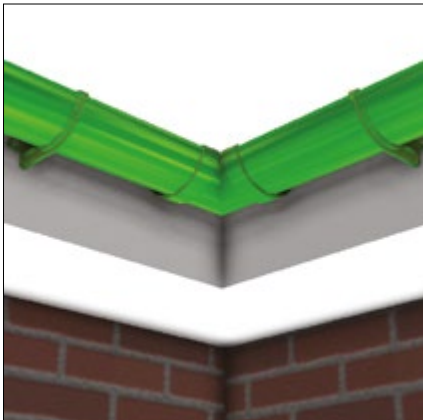

4. Support all corner angles by fixing fascia brackets a maximum of 150mm from each side.



5. Prior to assembling gutter joints, apply sealant to the central grooves to both sides of the ribbed rubber gasket. Use only Marley Alutec sealant, code SC101.

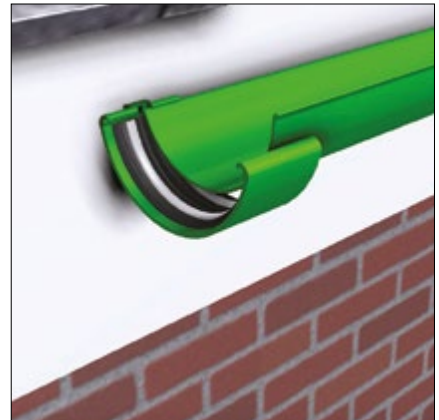

6. Place the gutter into the fascia brackets without clipping the front down. Position the union onto the rear of the gutter then snap the gutter fully into the fascia brackets. Finally apply upward pressure to the union clip from the bottom, whilst pulling the front gutter edge into the union clip.

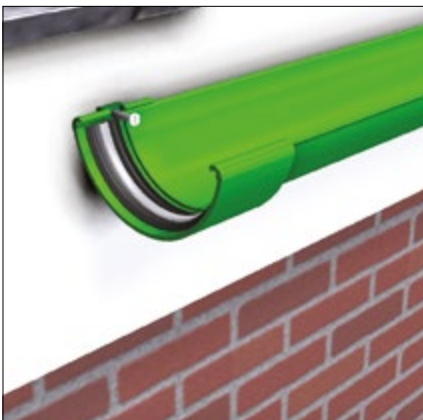

7. Anchor joint union to fascia board using Marley Alutec No. 10 x 32mm roundhead screws SC201 or Marley Alutec No. 10 x 15mm countersunk screw, code SC203 if fixing to Marley Alutec aluminium composite fascia. Drilling a pilot hole first is recommended.

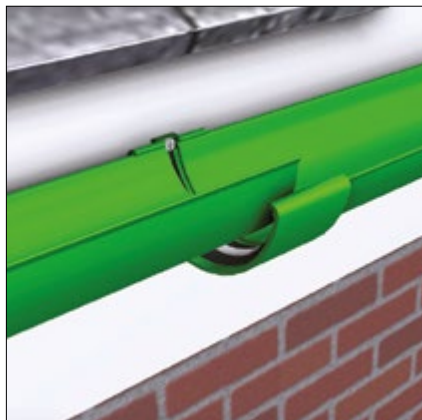

8. Repeat stages 5 & 6 and joint the gutter length to the one previously fixed. Ensure a 3mm expansion gap is left between the gutter ends.



9. Anchor outlets to fascia board using Marley Alutec No. 10 x 32mm roundhead screws SC201 or Marley Alutec No. 10 x 15mm countersunk screw, code SC203 if fixing to Marley Alutec aluminium composite fascia. Drilling a pilot hole first is recommended.

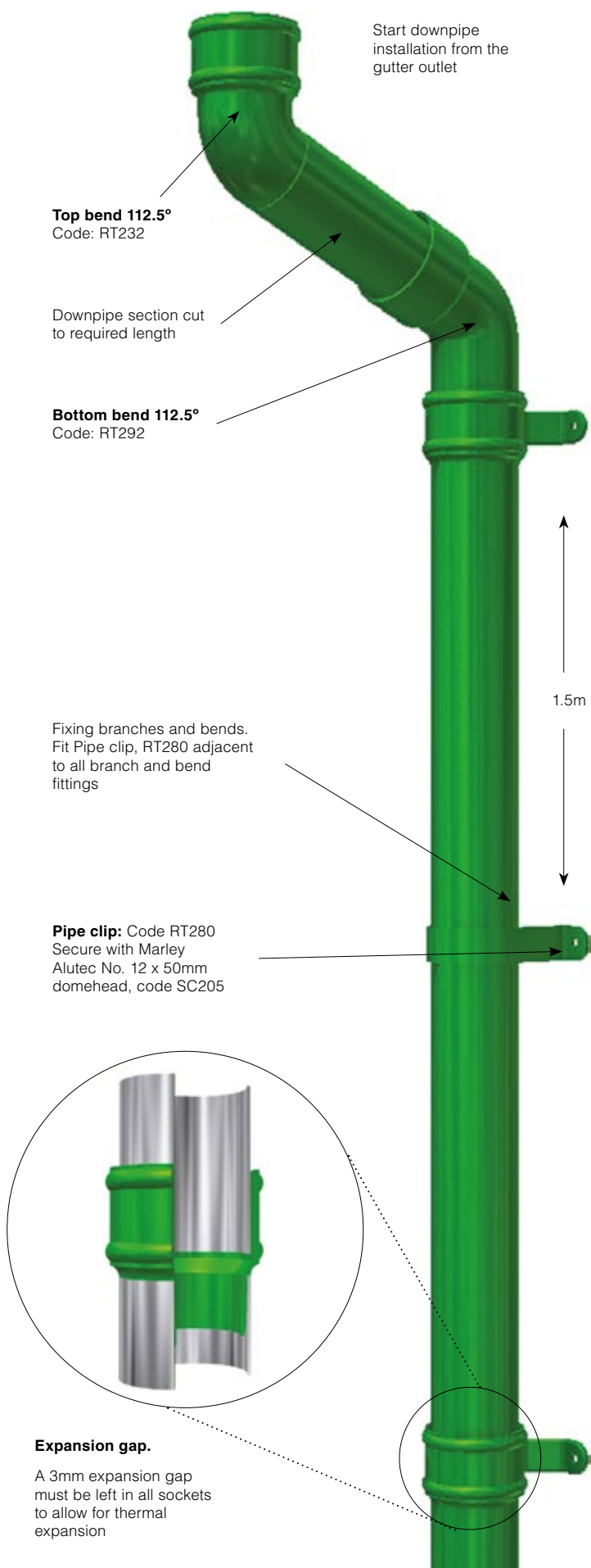

General Guidance

Preparation

Fascia boards should be in good condition, level and in linear alignment (straight). If required, packing shim plates should be fixed behind gutter brackets to achieve good alignment. The fascia should be capable of supporting the gutter when full of water, ice or snow. Where gutter is fixed to PVC-ue cellular fascia board, it is recommended that a timber support framework is installed behind the fascia to provide a straight and secure fixing surface.

Use standard metal work tools to cut or drill aluminium gutters. Angle grinders are not recommended. Where gutter or fittings are polyester powder coated, cut edges should be deburred and repainted with touch up paint, SC880.

Gutter position

Gutters must be installed level or to a fall of 1:600. The gutter should not be positioned at a level which causes rainfall to overshoot the gutter, i.e. too low, or where it is damaged by the high velocity impact of sliding snow, i.e. too high.

Snowloading

Heavy snowfall coupled with highly insulated roofs is causing accumulation of snow on roofs. A sudden thaw will then cause the snow to slide down the roof and rest against the gutters if they are fixed too high. Greater care must be taken to make sure the gutters will not impede sliding snow. However, for the ultimate protection, snow guards must be installed.

Joining

Joint sealing must not be carried out in wet weather or in temperatures below 5°C or above 40°C. Joint surfaces must be perfectly clean and dry. Use a clean cloth and solvent cleaner SC108 to remove all traces of dirt or grease, which may not be visible.

Ensure that the gutter joint sockets/spigots are correctly aligned with each other to ensure free thermal movement within the gutter joint. Only Marley Alutec high performance low modulus sealant SC101 must be used. Use of other sealants may result in early joint failure. Sealant over nine months old must not be used.

Fixing

To ensure the long term durability of aluminium gutter systems, it is vitally important to ensure that the fixing components are equally durable and capable of providing the necessary support. They must therefore be non corrosive, of a compatible material to ensure no electrolytic corrosion occurs and of the appropriate size. Only the recommended austenitic stainless steel screws must be used to fix gutters, whether direct, fascia or rafter bracket fixed.

If fixing to fascia boards made of materials other than wood or Marley Alutec aluminium composites, please call the Marley Alutec Technical Services Department.

Testing

On completion of an installation, blank off all gutter outlets. Fill gutter to overflow level and leave for 5 minutes, then check for leakage. Discharging the flood test water into rainwater pipes will identify any leaks in rainwater pipe joints. Any joints that fail should be taken apart, all sealant cleaned off, then re-sealed and re-tested.

Fixing gutters to rafters

For top or side rafter fixings, use traditional one piece rafter brackets available for all sizes and profiles of gutters.

Traditional top & side rafter arm brackets are supplied to a 45° roof pitch and if required should be site bent to the required roof pitch prior to fixing.

Bracket centres will be dictated by the rafters, which should not exceed 1m. Internal/external gutter corner angles and outlets should be independently supported. It is recommended that a timber bridge between adjacent rafters should be provided to which a rafter bracket can be fixed to fully support the outlet or angle.

Rise & fall drive in brackets

Fix directly into the brickwork/masonry by drilling out an opening in the mortar, inserting a hardwood or plastic spacer, then hammering the spike into the opening. Care should be taken to ensure that the vertical threaded rods are all in line to achieve the correct line of gutter. Bracket centres should not exceed 1m, with additional brackets either side of each outlet and corner angle. Reduce bracket centres in locations where heavy snow loading is anticipated.

General Guidance

Preparation

Fascia boards should be in good condition, level and in linear alignment (straight). If required, packing shim plates should be fixed behind gutter brackets to achieve good alignment. The fascia should be capable of supporting the gutter when full of water, ice or snow. Where gutter is fixed to PVC-ue cellular fascia board, it is recommended that a timber support framework is installed behind the fascia to provide a straight and secure fixing surface.

Use standard metal work tools to cut or drill aluminium gutters. Angle grinders are not recommended. Where gutter or fittings are polyester powder coated, cut edges should be deburred and repainted with touch up paint, SC880.

Gutter position

Gutters must be installed level or to a fall of 1:600. The gutter should not be positioned at a level which causes rainfall to overshoot the gutter, i.e. too low, or where it is damaged by the high velocity impact of sliding snow, i.e. too high.

Snowloading

Heavy snowfall coupled with highly insulated roofs is causing accumulation of snow on roofs. A sudden thaw will then cause the snow to slide down the roof and rest against the gutters if they are fixed too high. Greater care must be taken to make sure the gutters will not impede sliding snow. However, for the ultimate protection, snow guards must be installed.

Jointing

Joint sealing must not be carried out in wet weather or in temperatures below 5°C or above 40°C. Joint surfaces must be perfectly clean and dry. Use a clean cloth and solvent cleaner SC108 to remove all traces of dirt or grease, which may not be visible.

Ensure that the gutter joint sockets/spigots are correctly aligned with each other to ensure free thermal movement within the gutter joint.

Only Alutec high performance low modulus sealant SC101 must be used. Use of other sealants may result in early joint failure. Sealant over nine months old must not be used.

Fixing

To ensure the long term durability of aluminium gutter systems, it is vitally important to ensure that the fixing components are equally durable and capable of providing the necessary support. They must therefore be non corrosive, of a compatible material to ensure no electrolytic corrosion occurs and of the appropriate size. Only the recommended austenitic stainless steel screws must be used to fix gutters, whether direct, fascia or rafter bracket fixed.

If fixing to fascia boards made of materials other than wood or Alutec aluminium composites, please call the Alutec Technical Services Department.

Testing

On completion of an installation, blank off all gutter outlets. Fill gutter to overflow level and leave for 5 minutes, then check for leakage. Discharging the flood test water into rainwater pipes will identify any leaks in rainwater pipe joints. Any joints that fail should be taken apart, all sealant cleaned off, then re-sealed and re-tested.



1. Set gutter height by laying a straight batten on the lowest profile of the roof.

Place the fascia bracket under the batten so that they are touching and mark the screw holes.



2. Fix fascia brackets with Alutec 32mm x No. 10 roundhead screws, code SC201 or Alutec 15mm x No. 10 countersunk screw, code SC203 if fixing to Alutec aluminium composite fascia. Drilling pilot holes first is recommended.



3. Fix fascia brackets at 1 metre centres.

For best flow rate fix to a fall of 1:600 or alternatively nominally level.



4. Support all corner angles by fixing fascia brackets a maximum of 150mm from each side.

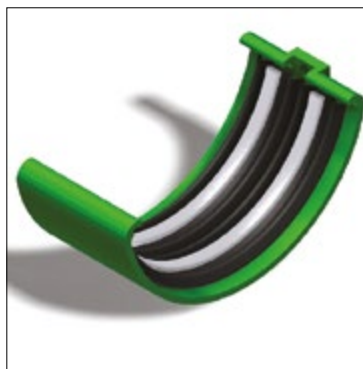

5. Prior to assembling gutter joints, apply sealant to the central grooves to both sides of the ribbed rubber gasket. Use only Alutec sealant, code SC101.

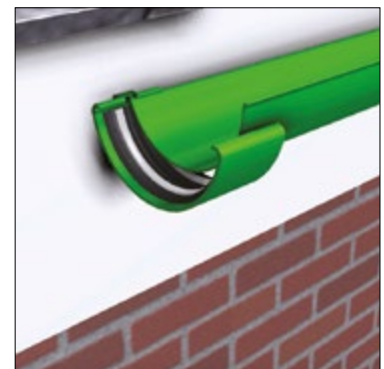

6. Place the gutter into the fascia brackets without clipping the front down. Position the union onto the rear of the gutter then snap the gutter fully into the fascia brackets.

Finally apply upward pressure to the union clip from the bottom, whilst pulling the front gutter edge into the union clip.

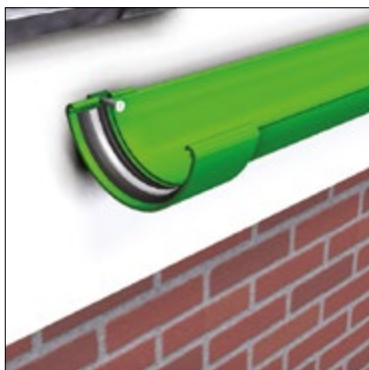

- Anchor joint union to fascia board using Alutec 32mm x No. 10 roundhead screws SC201 or Alutec 15mm x No. 10 countersunk screw, code SC203 if fixing to Alutec aluminium composite fascia.

Drilling a pilot hole first is recommended.

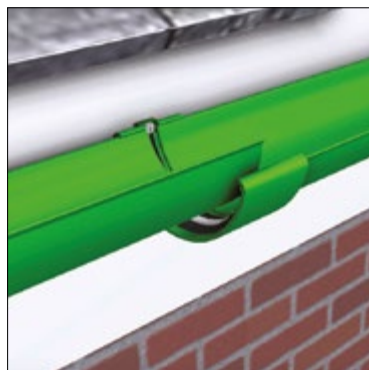

- Repeat stages 5 & 6 and joint the gutter length to the one previously fixed.

Ensure a 3mm expansion gap is left between the gutter ends.



- Anchor outlets to fascia board using Alutec 32mm x No. 10 roundhead screws SC201 or Alutec 15mm x No. 10 countersunk screw, code SC203 if fixing to Alutec aluminium composite fascia. Drilling a pilot hole first is recommended.

Fixing gutters to rafters

For top or side rafter fixings, use traditional one piece rafter brackets available for all sizes and profiles of gutters.

Traditional top & side rafter arm brackets are supplied to a 45° roof pitch and if required should be site bent to the required roof pitch prior to fixing.

Bracket centres will be dictated by the rafters, which should not exceed 1m. Internal/external gutter corner angles and outlets should be independently supported. It is recommended that a timber bridge between adjacent rafters should be provided to which a rafter bracket can be fixed to fully support the outlet or angle.

Rise & fall drive in brackets

Fix directly into the brickwork/masonry by drilling out an opening in the mortar, inserting a hardwood or plastic spacer, then hammering the spike into the opening. Care should be taken to ensure that the vertical threaded rods are all in line to achieve the correct line of gutter. Bracket

centres should not exceed 1m, with additional brackets either side of each outlet and corner angle. Reduce bracket centres in locations where heavy snow loading is anticipated.

General Guidance

Preparation

Fascia boards should be in good condition, level and in linear alignment (straight). If required, packing shim plates should be fixed behind gutter brackets to achieve good alignment. The fascia should be capable of supporting the gutter when full of water, ice or snow. Where gutter is fixed to PVC-ue cellular fascia board, it is recommended that a timber support framework is installed behind the fascia to provide a straight and secure fixing surface.

Use standard metal work tools to cut or drill aluminium gutters. Angle grinders are not recommended. Where gutter or fittings are polyester powder coated, cut edges should be deburred and repainted with touch up paint, SC880.

Gutter position

Gutters must be installed level or to a fall of 1:600. The gutter should not be positioned at a level which causes rainfall to overshoot the gutter, i.e. too low, or where it is damaged by the high velocity impact of sliding snow, i.e. too high.

Snowloading

Heavy snowfall coupled with highly insulated roofs is causing accumulation of snow on roofs. A sudden thaw will then cause the snow to slide down the roof and rest against the gutters if they are fixed too high. Greater care must be taken to make sure the gutters will not impede sliding snow. However, for the ultimate protection, snow guards must be installed.

Jointing

Joint sealing must not be carried out in wet weather or in temperatures below 5°C or above 40°C. Joint surfaces must be perfectly clean and dry. Use a clean cloth and solvent cleaner SC108 to remove all traces of dirt or grease, which may not be visible.

Ensure that the gutter joint sockets/spigots are correctly aligned with each other to ensure free thermal movement within the gutter joint.

Only Alutec high performance low modulus sealant SC101 must be used. Use of other sealants may result in early joint failure. Sealant over nine months old must not be used.

Fixing

To ensure the long term durability of aluminium gutter systems, it is vitally important to ensure that the fixing components are equally durable and capable of providing the necessary support. They must therefore be non corrosive, of a compatible material to ensure no electrolytic corrosion occurs and of the appropriate size. Only the recommended austenitic stainless steel screws must be used to fix gutters, whether direct, fascia or rafter bracket fixed.

If fixing to fascia boards made of materials other than wood or Alutec aluminium composites, please call the Alutec Technical Services Department.

Testing

On completion of an installation, blank off all gutter outlets. Fill gutter to overflow level and leave for 5 minutes, then check for leakage. Discharging the flood test water into rainwater pipes will identify any leaks in rainwater pipe joints. Any joints that fail should be taken apart, all sealant cleaned off, then re-sealed and re-tested.



1. Set gutter height by laying a straight batten on the lowest profile of the roof. Place the fascia bracket under the batten so that they are touching and mark the screw holes.



2. Fix fascia brackets with Alutec 32mm x No. 10 roundhead screws, code SC201 or Alutec 15mm x No. 10 countersunk screw, code SC203 if fixing to Alutec aluminium composite fascia. Drilling pilot holes first is recommended.



3. Fix fascia brackets at 1 metre centres. For best flow rate fix to a fall of 1:600 or alternatively nominally level.



4. Hook the front edge of the gutter into the front of the fascia brackets.



5. Swing the rear of the gutter upwards and engage into the fascia brackets.



6. Prior to assembling gutter joints, apply sealant to the central grooves. Use only Alutec sealant, code SC101.

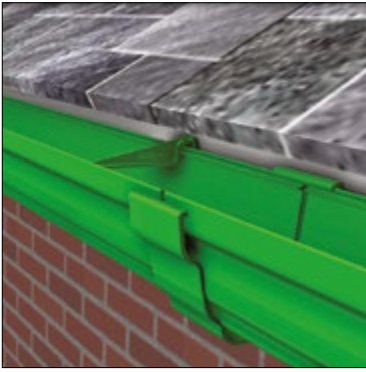

7. Push the union from below upwards over the gutter, clipping over the rear first, followed by the front of the gutter. Follow the same fitting process for outlets, angles and stop-ends.

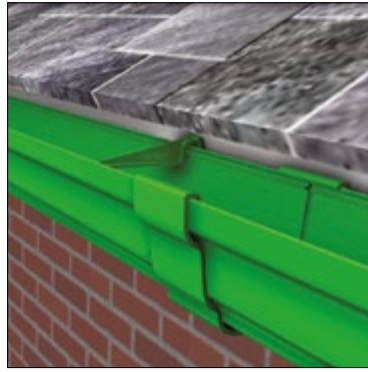

8. Repeat stages 5 & 6 and joint the gutter length to the one previously fixed. Ensure a 3mm expansion gap is left between the gutter ends.



9. Anchor all fittings to fascia board using Alutec 32mm x No. 10 roundhead screws, code SC201 or Alutec 15mm x No. 10 countersunk screw, code SC203 if fixing to Alutec aluminium composite fascia.

Drilling a pilot hole first is recommended.

General Guidance

Preparation

Fascia boards should be in good condition, level and in linear alignment (straight). If required, packing shim plates should be fixed behind gutter brackets to achieve good alignment. The fascia should be capable of supporting the gutter when full of water, ice or snow. Where gutter is fixed to PVC-ue cellular fascia board, it is recommended that a timber support framework is installed behind the fascia to provide a straight and secure fixing surface.

Use standard metal work tools to cut or drill aluminium gutters. Angle grinders are not recommended. Where gutter or fittings are polyester powder coated, cut edges should be deburred and repainted with touch up paint, SC880.

Gutter position

Gutters must be installed level or to a fall of 1:600. The gutter should not be positioned at a level which causes rainfall to overshoot the gutter, i.e. too low, or where it is damaged by the high velocity impact of sliding snow, i.e. too high.

Snowloading

Heavy snowfall coupled with highly insulated roofs is causing accumulation of snow on roofs. A sudden thaw will then cause the snow to slide down the roof and rest against the gutters if they are fixed too high. Greater care must be taken to make sure the gutters will not impede sliding snow. However, for the ultimate protection, snow guards must be installed.

Jointing

Joint sealing must not be carried out in wet weather or in temperatures below 5°C or above 40°C. Joint surfaces must be perfectly clean and dry. Use a clean cloth and solvent cleaner SC108 to remove all traces of dirt or grease, which may not be visible.

Ensure that the gutter joint sockets/spigots are correctly aligned with each other to ensure free thermal movement within the gutter joint.

Only Alutec high performance low modulus sealant SC101 must be used. Use of other sealants may result in early joint failure. Sealant over nine months old must not be used.

Fixing

To ensure the long term durability of aluminium gutter systems, it is vitally important to ensure that the fixing components are equally durable and capable of providing the necessary support.

They must therefore be non corrosive, of a compatible material to ensure no electrolytic corrosion occurs and of the appropriate size.

Only the recommended austenitic stainless steel screws must be used to fix gutters, whether direct, fascia or rafter bracket fixed.

If fixing to fascia boards made of materials other than wood or Alutec aluminium composites, please call the Alutec Technical Services Department.

Testing

On completion of an installation, blank off all gutter outlets. Fill gutter to overflow level and leave for 5 minutes, then check for leakage. Discharging the flood test water into rainwater pipes will identify any leaks in rainwater pipe joints. Any joints that fail should be taken apart, all sealant cleaned off, then re-sealed and re-tested.



1. Set gutter height by laying a straight batten on the lowest profile of the roof. Place the fascia bracket under the batten so that they are touching and mark the screw holes.



2. Fix fascia brackets with Alutec 32mm x No. 10 roundhead screws, code SC201 or Alutec 15mm x No. 10 countersunk screw, code SC203 if fixing to Alutec aluminium composite fascia. Drilling pilot holes first is recommended.



3. Fix fascia brackets at 915mm centres. For best flow rate, fix to a fall of 1:600 or alternatively nominally level.



4. Support all corner angles and outlets by fixing fascia brackets a maximum of 150mm from each side.



5. Place gutters into the fascia brackets and press down to engage into fascia brackets. Do not slide the gutter into the fascia brackets, as this may result in the gutter surface being marked.



6. Clean all joint surfaces using a clean cloth and Alutec solvent cleaner, code SC108. Ensure all surfaces are dry and then apply two 8mm parallel beads of Alutec sealant, code SC101 to the gutter socket and around the bolt hole.

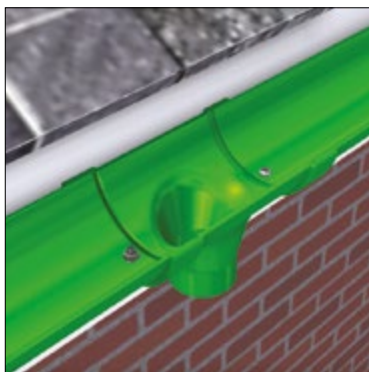

7. Nuts and washers can be located inside or outside the gutter. Bolt heads outside the gutter will appear neater, but the internally projecting thread will have a minor effect on flow rate performance. Both options are illustrated.

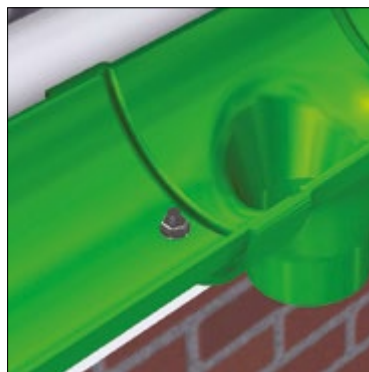

8. Finger tighten nut and bolt only, pull the joint apart sideways to ensure a minimum 3mm expansion gap is achieved. Then tighten one full turn only, with a spanner or screwdriver.

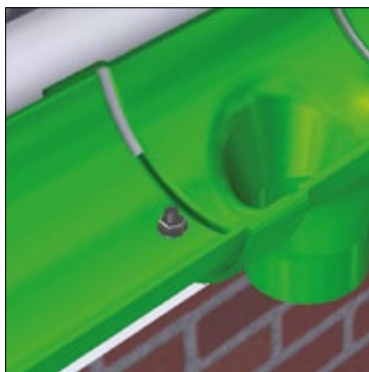

9. Point sealant onto joint gap, adding additional Alutec sealant, code SC101 if required. Clean off any excess with Alutec solvent cleaner, code SC108.

Fixing gutters to rafters

For top or side rafter fixings, use traditional one piece rafter brackets available for all sizes and profiles of gutters.

Bracket centres will be dictated by the rafters which should not exceed 915mm. Internal/external gutter corner angles and outlets should be independently supported. It is recommended that a timber bridge between adjacent rafters should be provided to which a rafter bracket can be fixed to fully support the outlet or angle.

Rise & fall drive in brackets

Fix directly into the brickwork/masonry by drilling out an opening in the mortar, inserting a hardwood or plastic spacer, then hammering the spike into the opening. Care should be taken to ensure that the vertical threaded rods are all in line to achieve the correct line of gutter. Bracket centres should not exceed 915mm, with additional brackets either side of each outlet and corner angle. Reduce bracket centres in locations where heavy snow loading is anticipated.

Direct fixing

Victorian Ogee. Screw to fascia through slots provided to the rear of the gutter, with screws, SC201 and backing washers, SC521.

Moulded Ogee. Screw to fascia through slots provided to the rear of the gutter, with direct fix spacer brackets, GM581, using screws, SC201 and backing washers, SC521.

General Guidance

Preparation

Fascia boards should be in good condition, level and in linear alignment (straight). If required, packing shim plates should be fixed behind gutter brackets to achieve good alignment.

The fascia should be capable of supporting the gutter when full of water, ice or snow.

Where gutter is fixed to PVC-ue cellular fascia board, it is recommended that a timber support framework is installed behind the fascia to provide a straight and secure fixing surface.

Use standard metal work tools to cut or drill aluminium gutters. Angle grinders are not recommended. Where gutter or fittings are polyester powder coated, cut edges should be deburred and repainted with touch up paint, SC880.

Gutter position

Gutters must be installed level or to a fall of 1:600. The gutter should not be positioned at a level which causes rainfall to overshoot the gutter, i.e. too low, or where it is damaged by the high velocity impact of sliding snow, i.e. too high.

Snowloading

Heavy snowfall coupled with highly insulated roofs is causing accumulation of snow on roofs.

A sudden thaw will then cause the snow to slide down the roof and rest against the gutters if they are fixed too high. Greater care must be taken to make sure the gutters will not impede sliding snow. However, for the ultimate protection, snow guards must be installed.

Jointing

Joint sealing must not be carried out in wet weather or in temperatures below 5°C or above 40°C. Joint surfaces must be perfectly clean and dry. Use a clean cloth and solvent cleaner SC108 to remove all traces of dirt or grease, which may not be visible.

Ensure that the gutter joint sockets/spigots are correctly aligned with each other to ensure free thermal movement within the gutter joint.

Only Alutec high performance low modulus sealant SC101 must be used. Use of other sealants may result in early joint failure. Sealant over nine months old must not be used.

Fixing

To ensure the long term durability of aluminium gutter systems, it is vitally important to ensure that the fixing components are equally durable and capable of providing the necessary support.

They must therefore be non corrosive, of a compatible material to ensure no electrolytic corrosion occurs and of the appropriate size.

Only the recommended austenitic stainless steel screws must be used to fix gutters, whether direct, fascia or rafter bracket fixed.

If fixing to fascia boards made of materials other than wood or Alutec aluminium composites, please call the Alutec Technical Services Department.

Testing

On completion of an installation, blank off all gutter outlets. Fill gutter to overflow level and leave for 5 minutes, then check for leakage. Discharging the flood test water into rainwater pipes will identify any leaks in rainwater pipe joints. Any joints that fail should be taken apart, all sealant cleaned off, then re-sealed and re-tested.



1. Set gutter height by laying a straight batten on the lowest profile of the roof.

Place the fascia bracket under the batten so that they are touching and mark the screw holes.



2. Fix fascia brackets with Alutec 32mm x No. 10 roundhead screws, code SC201 or Alutec 15mm x No. 10 countersunk screw, code SC203 if fixing to Alutec aluminium composite fascia. Drilling pilot holes first is recommended.



3. Fix fascia brackets at 1m centres. For best flow rate, fix to a fall of 1:600 or alternatively nominally level.

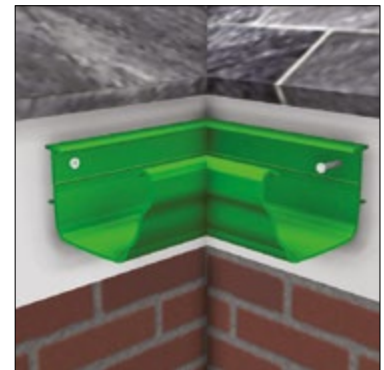

4. Fix all gutter angles with 2 no. Alutec 32mm x No. 10 countersunk screw, code SC202 or Alutec 15mm x No. 10 countersunk screw, code SC203 if fixing to Alutec aluminium composite fascia.



5. Position outlets and fix using Alutec 32mm x No. 10 countersunk screw, code SC202 or Alutec 15mm x No. 10 countersunk screw, code SC203 if fixing to Alutec aluminium composite fascia.

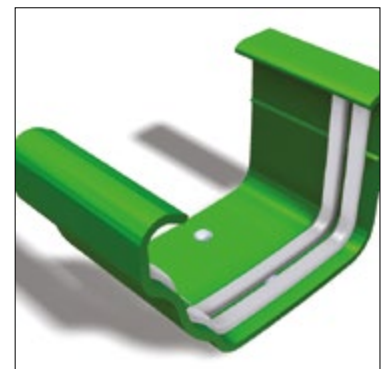

6. Ensure the factory fitted rubber compression spacers are attached to the inside of the union. Clean all joint surfaces using a clean cloth and Alutec solvent cleaner, code SC108. Ensure all surfaces are dry and then apply two 8mm parallel beads of Alutec sealant, code SC101 to each side of the union.

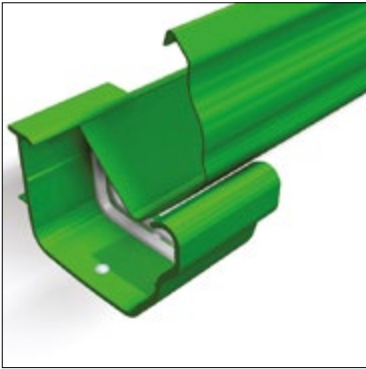

7. Fit union to end of gutter as illustrated.

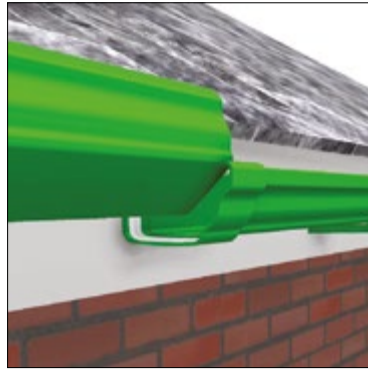

8. Fit gutter into fascia brackets by inserting the rear upstand, then snapping down the front. Repeat steps 6, 7 & 8.



9. Anchor union to fascia board using Alutec 32mm x No. 10 screw, code SC202 or Alutec 15mm x No. 10 countersunk screw, code SC203 if fixing to Alutec aluminium composite fascia. Ensure a 3-4mm expansion gap is left.

Point excess sealant well into the joint edges adding additional sealant if required. Clean off surplus with Alutec solvent cleaner, code SC108.

Installation of Aligator® 63mm Ø and 62x62mm downpipe



Start downpipe installation from the gutter outlet

Top bend 112.5°
Code: RT232

Downpipe section
cut to required length

Bottom bend 112.5°
Code: RT292

Fixing branches and bends. Fit pipe clip adjacent to all branch and bend fittings
Code: RT280

Pipe clip:
Code RT280
Secure with Alutec 50mm x No. 12 domehead, code SC205

1.5m

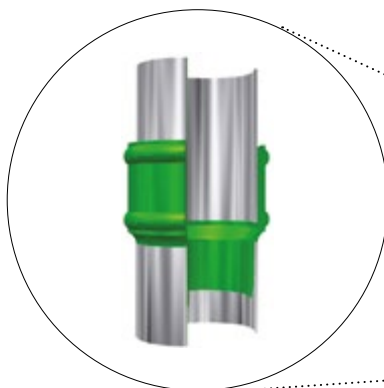

Expansion gap.
A 3mm expansion gap must be left in all sockets to allow for thermal expansion. Aligator® Classic 62x62mm sockets must be sealed with Alutec sealant, code SC101.

General Guidance

Preparation

Fascia boards should be in good condition, level and in linear alignment (straight). If required, packing shim plates should be fixed behind gutter brackets to achieve good alignment.

The fascia should be capable of supporting the gutter when full of water, ice or snow. Where gutter is fixed to PVC-ue cellular fascia board, it is recommended that a timber support framework is installed behind the fascia to provide a straight and secure fixing surface.

Use standard metal work tools to cut or drill aluminium gutters. Angle grinders are not recommended. Where gutter or fittings are polyester powder coated, cut edges should be deburred and repainted with touch up paint, SC880.

Gutter position

Gutters must be installed level or to a fall of 1:600. The gutter should not be positioned at a level which causes rainfall to overshoot the gutter, i.e. too low, or where it is damaged by the high velocity impact of sliding snow, i.e. too high.

Snowloading

Heavy snowfall coupled with highly insulated roofs is causing accumulation of snow on roofs. A sudden thaw will then cause the snow to slide down the roof and rest against the gutters if they are fixed too high. Greater care must be taken to make sure the gutters will not impede sliding snow. However, for the ultimate protection, snow guards must be installed.

Jointing

Joint sealing must not be carried out in wet weather or in temperatures below 5°C or above 40°C. Joint surfaces must be perfectly clean and dry. Use a clean cloth and solvent cleaner SC108 to remove all traces of dirt or grease, which may not be visible.

Ensure that the gutter joint sockets/spigots are correctly aligned with each other to ensure free thermal movement within the gutter joint.

Only Alutec high performance low modulus sealant SC101 must be used. Use of other sealants may result in early joint failure. Sealant over nine months old must not be used.

Fixing

To ensure the long term durability of aluminium gutter systems, it is vitally important to ensure that the fixing components are equally durable and capable of providing the necessary support. They must therefore be non corrosive, of a compatible material to ensure no electrolytic corrosion occurs and of the appropriate size.

Only the recommended austenitic stainless steel screws must be used to fix gutters, whether direct, fascia or rafter bracket fixed. If fixing to fascia boards made of materials other than wood or Alutec aluminium composites, please call the Alutec Technical Services Department.

Testing

On completion of an installation, blank off all gutter outlets. Fill gutter to overflow level and leave for 5 minutes, then check for leakage. Discharging the flood test water into rainwater pipes will identify any leaks in rainwater pipe joints. Any joints that fail should be taken apart, all sealant cleaned off, then re-sealed and re-tested.

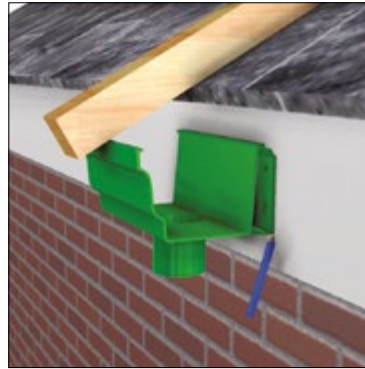

1. Set gutter height by laying a straight batten on the lowest profile of the roof.

Place the gutter outlet under the batten so that they are touching and mark the screw holes.



2. Fix fascia brackets with Alutec 32mm x No. 10 roundhead screws, code SC201 or Alutec 15mm x No. 10 countersunk screw, code SC203 if fixing to Alutec aluminium composite fascia. Insert screw into lower slot and adjust to the string line.

Drilling pilot holes first is recommended.

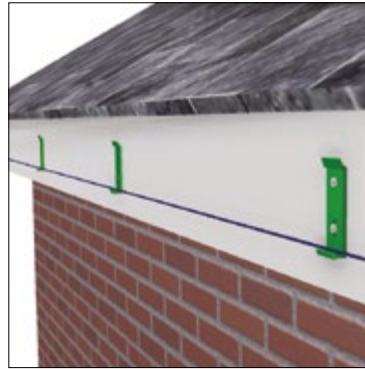

3. Fix fascia brackets at 750mm centres.

For best flow rate, fix to a fall of 1:600 or alternatively nominally level.



4. Fix an additional fascia bracket centrally to one side of each angle and centrally to each outlet.



5. Check fascia board alignment; if required, shim out brackets using appropriate shim plates. Deepflow: SC380, Ogee No. 46, Boxer 135x100mm and Boxer 160x100mm: SC381, Boxer 120x80mm: SC382.

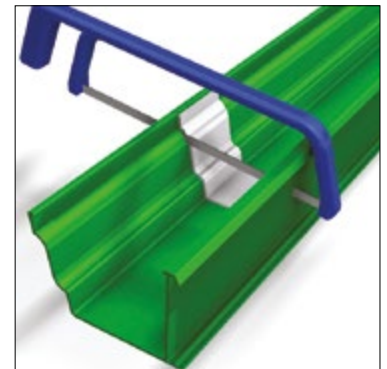

6. To achieve a neat cut through the gutter, place a union into the gutter and use as a cutting guide.



7. Hook the rear of the gutter over the top of the fascia brackets and then swing down to secure into the base of the fascia brackets.

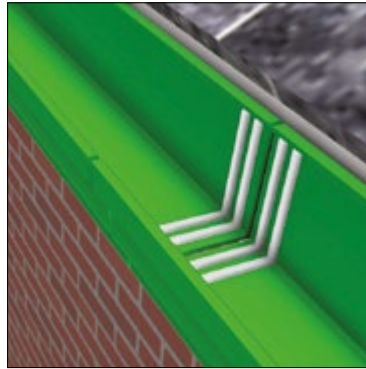

8. Clean all joint surfaces using a clean cloth and Alutec solvent cleaner, code SC108. Ensure all surfaces are dry and then apply two 8mm parallel beads of Alutec sealant, code SC101 to each gutter end.

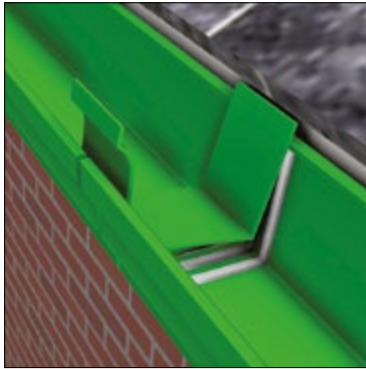

9. Check that the factory fitted rubber compression spacers are fitted to the underside of the unions. Insert union, taking care not to remove sealant from the vertical faces.

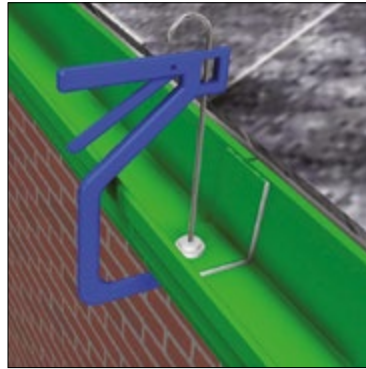

10. Secure union into gutter by engaging into the rear upstand and then the front using Alutec gutter compression tool, code SC104.

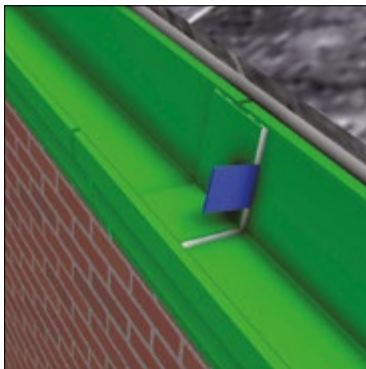

11. Point excess sealant well into the joint edges adding additional sealant if required.

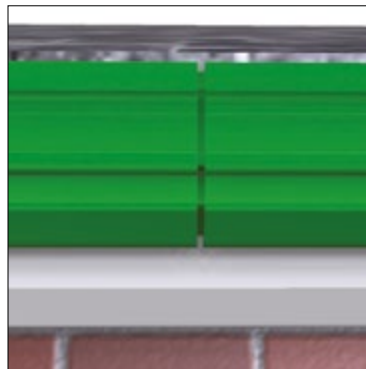

12. Clean off any excess sealant to visible surfaces using Alutec solvent cleaner, code SC108 and ensure that all joints have a 3-4mm expansion gap.

General Guidance

Preparation

Fascia boards should be in good condition, level and in linear alignment (straight). If required, packing shim plates should be fixed behind gutter brackets to achieve good alignment. The fascia should be capable of supporting the gutter when full of water, ice or snow.

Where gutter is fixed to PVC-ue cellular fascia board, it is recommended that a timber support framework is installed behind the fascia to provide a straight and secure fixing surface.

Use standard metal work tools to cut or drill aluminium gutters. Angle grinders are not recommended. Where gutter or fittings are polyester powder coated, cut edges should be deburred and repainted with touch up paint, SC880.

Gutter position

Gutters must be installed level or to a fall of 1:600. The gutter should not be positioned at a level which causes rainfall to overshoot the gutter, i.e. too low, or where it is damaged by the high velocity impact of sliding snow, i.e. too high.

Snowloading

Heavy snowfall coupled with highly insulated roofs is causing accumulation of snow on roofs. A sudden thaw will then cause the snow to slide down the roof and rest against the gutters if they are fixed too high. Greater care must be taken to make sure the gutters will not impede sliding snow. However, for the ultimate protection, snow guards must be installed.

Jointing

Joint sealing must not be carried out in wet weather or in temperatures below 5°C or above 40°C. Joint surfaces must be perfectly clean and dry. Use a clean cloth and solvent cleaner SC108 to remove all traces of dirt or grease, which may not be visible.

Ensure that the gutter joint sockets/spigots are correctly aligned with each other to ensure free thermal movement within the gutter joint.

Only Alutec high performance low modulus sealant SC101 must be used. Use of other sealants may result in early joint failure. Sealant over nine months old must not be used.

Fixing

To ensure the long term durability of aluminium gutter systems, it is vitally important to ensure that the fixing components are equally durable and capable of providing the necessary support. They must therefore be non corrosive, of a compatible material to ensure no electrolytic corrosion occurs and of the appropriate size. Only the recommended austenitic stainless steel screws must be used to fix gutters, whether direct, fascia or rafter bracket fixed.

If fixing to fascia boards made of materials other than wood or Alutec aluminium composites, please call the Alutec Technical Services Department.

Testing

On completion of an installation, blank off all gutter outlets. Fill gutter to $\frac{3}{4}$ full and leave for 5 minutes, then check for leakage. Discharging the flood test water into rainwater pipes will identify any leaks in rainwater pipe joints. Any joints that fail should be taken apart, all sealant cleaned off, then re-sealed and re-tested.

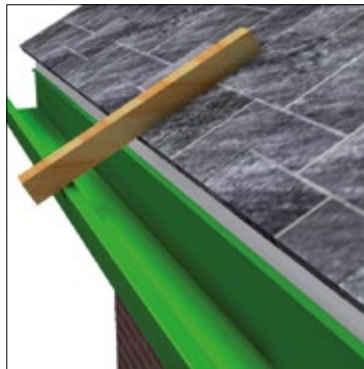

1. Set gutter height by laying a straight batten on the lowest profile of the roof. Place the gutter under the batten so that they are touching and mark the top lip. Use a chalk line or equivalent to set level as a reference for fixing gutters.

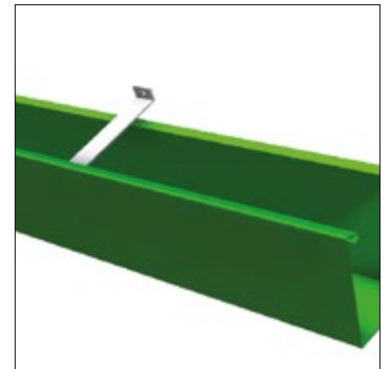

2. Secure stiffener brackets into the top front recess of the gutter in line with the pre-drilled holes at 750mm centres.



3. Clean all jointing surfaces with a clean cloth and Alutec solvent cleaner, code SC108.

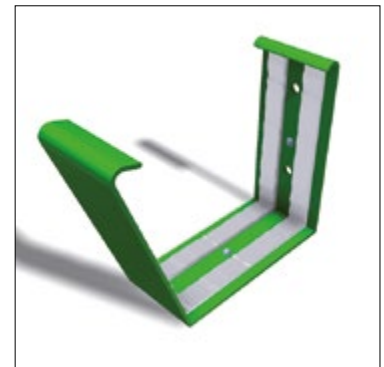

4. Check that factory fitted rubber compression spacers are fitted, then apply two 8mm parallel beads of Alutec sealant, code SC101 to both sides of the union.

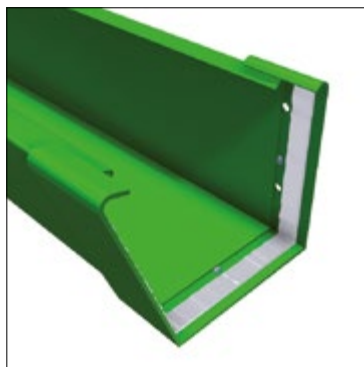

5. Fit the union to the end of the gutter by placing it onto the rear gutter edge first, bend in slightly the front face of the gutter and clip the union over the gutter's front edge.

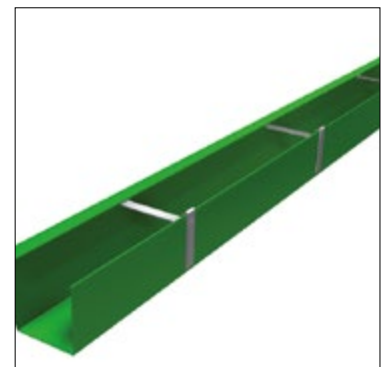

6. Hook rear spacer assemblies over rear upstand of gutter in line with pre-drilled holes and stiffener brackets.

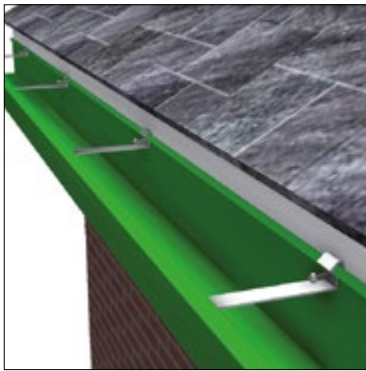

7. Fix the gutter to the fascia through the stiffener bracket fixing holes using Alutec 50mm x No. 12 screw, code SC231 and Alutec washer, code SC521.

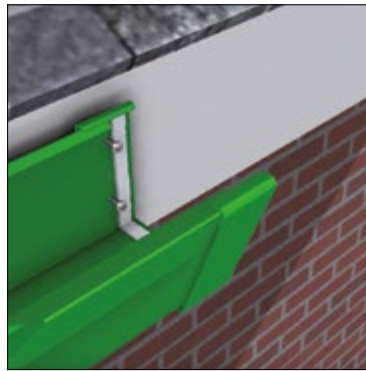

8. Anchor the unions and angles to the fascia using Alutec 32mm x No. 10 screw, code SC202.



9. Repeat steps 2, 3, 4, 5, & 6. Clip next gutter section into place, ensure a 3-4mm expansion gap and then fix gutter as described in step 7.

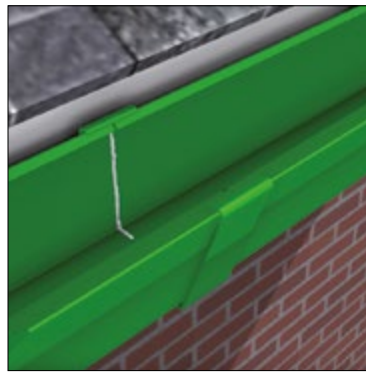

10. Add additional sealant if required and point any excess sealant well into the expansion gap. Dress sealant level with faces of gutter.

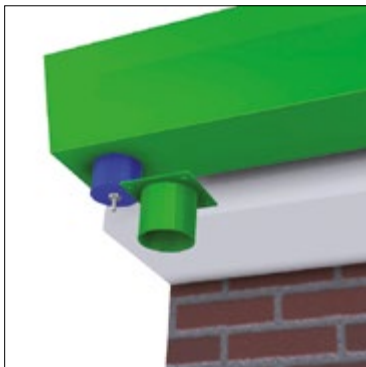

11. Fit patch outlet by cutting the appropriate size hole in-situ or prior to gutter fixing. Place patch outlet on the external face of the gutter, mark and drill four 6mm bolt holes. Apply Alutec sealant, code SC101 to joint faces and fix with the four supplied Alutec M6 aluminium bolts, nuts and washers, codes SC502, SC511 & SC521.



12. Clean off any excess sealant to visible surfaces using Alutec solvent cleaner, code SC108.

General Guidance

Bending to correct roof angle

Rafter arms are manufactured to suit a roof pitch of 30°. If the site roof pitch is different to this angle the rafter arms will need to be site bent in a similar fashion to the illustration shown above. Do not attempt to install the rafter arms and bend from the formed cradle as this may deform the shape of the bracket.

Rafter arm spacing

Rafter arms must not exceed 915mm centres.

Pilot drill all screw holes prior to inserting 30xNo10 compatible s/steel screw, code SC201.

For best flow rate, fix to a fall of 1:600 or alternatively nominally level.

Securing

Apply a small bead of Alutec sealant, code SC101 to the inside face of the rafter arms and place gutter into cradle. The sealant will act as a retaining adhesive.

For areas susceptible to high winds, it is advised that gutters are secured to the rafter arms at every second bracket with a stainless steel self tapping screw.

Bending to correct roof angle

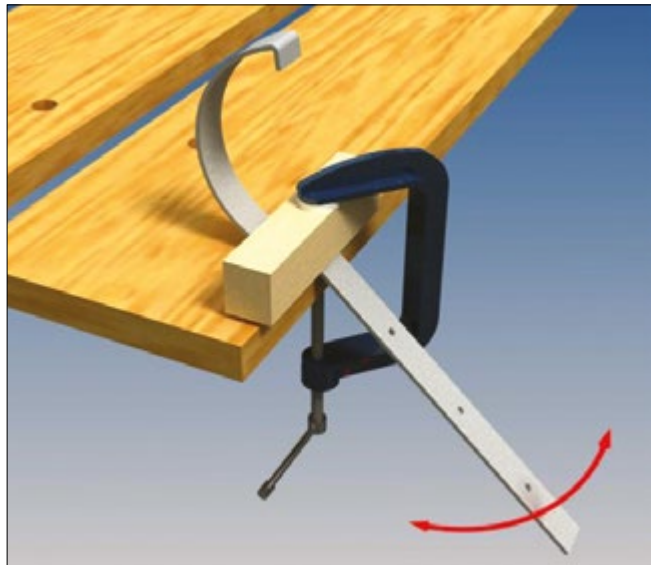

Rafter arm spacing

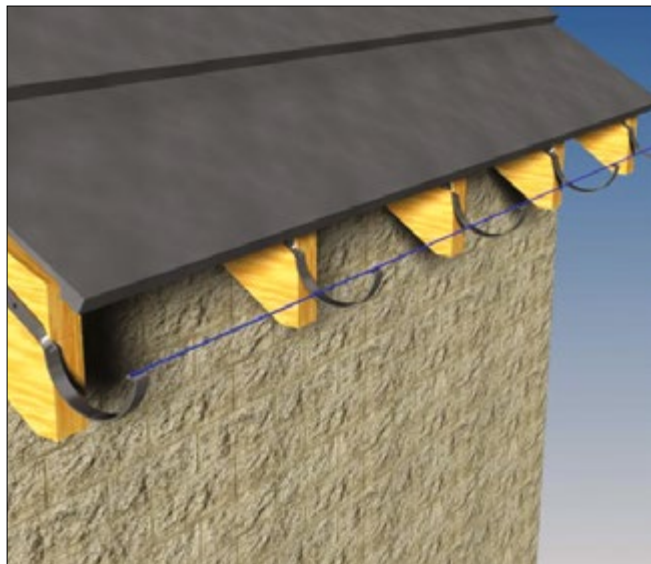

Securing



Gutter outlet / Hopper connection



Fixing

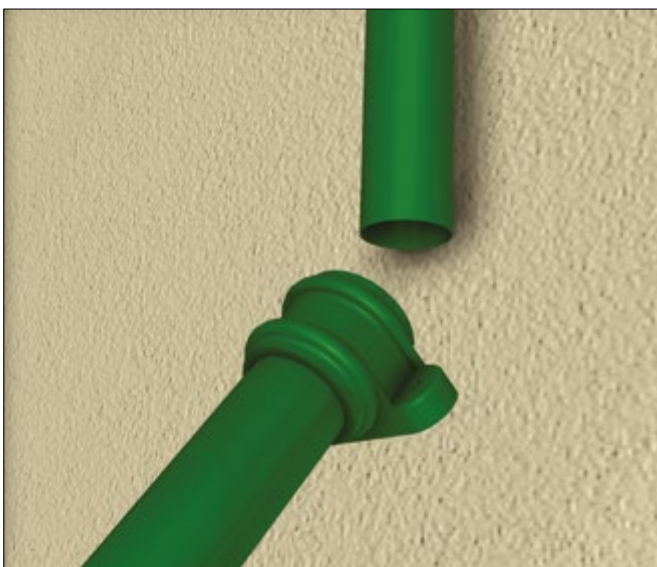

Drain Connection



General Guidance

Gutter outlet / Hopper connection

Connection to the gutter outlet and or hopper is made via a pipe socket. Pipe sockets are supplied with all offsets. Bespoke offsets can be made to order.

Fixing

For fixing to masonry via the cast sockets, use Alutec No. 16 x 70mm hex insert domehead, code SC208 with appropriate wall plugs. Intermediate pipe clips are not required. However, additional pipe clips must be fitted adjacent to inline bends and branches.

Downpipes can be spaced out a further 30mm from the wall by using Alutec Wall spacer, code SC712 with Alutec No. 16 x 100mm hex insert domehead, code SC209 with appropriate wall plugs.

If fixing to a non masonry background, please call Alutec Technical Services Department for advice.

Jointing

Joint sealing must not be carried out in wet weather or in temperatures below 5°C or above 40°C. Joint surfaces must be perfectly clean and dry. Use a clean cloth and Alutec solvent cleaner, code SC108 to remove all traces of dirt or grease, which may not be visible.

All pipe joints, including connection to the gutter outlet, must be sealed with Alutec sealant, code SC101. Ensure to allow a 3-4mm expansion gap between pipe lengths.

Pipe off-cuts can be used by fitting a pipe socket into a square cut end of pipe.

Drain Connection

Unless a shoe is used to terminate the pipe and discharge over an open gully, drain connections should preferably be made using the appropriate adaptor by the drainpipe manufacturer, e.g. connect to vitreous clay or PVCu drainage pipes with a universal EPDM rubber adaptor. For connection to cast iron drainage use a proprietary cast iron step coupling.

Testing

It is good practice to water test the downpipes after installation. If connected to a gutter system, the discharging of flood test water from the gutter should identify any leaks within the downpipe system. For downpipes connected to hoppers or flat roof outlets, discharging water at the top with a hose pipe for a period of 5 minutes under normal mains pressure should suffice. Any leaking joints should be taken apart and re-sealed and re-tested.

Lightning conductors

Under no circumstances should rainwater downpipes be used as a lightning conductor to earth. If pipes are to be bonded to a lightning conductor system, the specialist installer must use an electrolytically compatible external bonding strap and not drill and bolt through the pipe wall.

General Guidance

Gutter outlet / Hopper connection

Connection to the gutter outlet and or hopper is made via a pipe socket. Pipe sockets are supplied with all offsets. Bespoke offsets can be made to order.

Fixing

Traditional downpipes with eared cast sockets
For fixing to masonry via the cast sockets, use Alutec No. 16 x 70mm hex insert domehead, code SC208 with appropriate wall plugs. When fixed in this way, intermediate pipe clips are not required. However, additional pipe clips must be fitted adjacent to inline bends and branches.

Traditional downpipes with non eared cast sockets
For fixing to masonry, use the standard pipe clips and fix with Alutec No. 16 x 70mm hex insert domehead, code SC208 with appropriate wall plugs. One clip to be located directly under the pipe socket and a further clip 1.5 metres below. Additional pipe clips must be fitted adjacent to inline bends and branches.

Additional spacing from wall

Downpipes can be spaced out a further 30mm from the wall by using Alutec cast spacer bobbins with No. 16 x 100mm hex insert domehead, code SC209 with appropriate wall plugs.

If fixing to a non masonry background, please call Alutec Technical Services Department for advice.

Jointing

Joint sealing must not be carried out in wet weather or in temperatures below 5°C or above 40°C. Joint surfaces must be perfectly clean and dry. Use a clean cloth and Alutec solvent cleaner, code SC108 to remove all traces of dirt or grease, which may not be visible.

All joints to pipes with cast sockets must be sealed, including at the gutter outlet with Alutec sealant, code SC101. Access to seal the rear of the socket can be made easier by attaching a flexible piece of tube to the end of the sealant gun nozzle. Ensure to allow for a 3-4mm expansion gap between pipe lengths.

Pipe off cuts can be utilised by fitting a pipe socket to a square cut end of pipe. Ensure that a bead of Alutec sealant, code SC101 is placed within the internal recess of the pipe socket, prior to driving the socket onto the end of the pipe with a rubber/wooden mallet.

Drain Connection

Unless a shoe is used to terminate the pipe and discharge over an open gully, drain connections should preferably be made using the appropriate size Alutec square to round drain connector. The adaptor push-fits inside a 110mm Ø ring sealed drain socket. The deep square connection socket allows for an insert and lift slip connection of the bottom pipe between two fixed points.

Testing

It is good practice to water test the downpipes after installation. If connected to a gutter system the discharging of flood test water from the gutter should identify any leaks within the downpipe system. For downpipes connected to hoppers or flat roof outlets, discharging water at the top with a hose pipe for a period of 5 minutes under normal mains pressure should suffice. Any leaking joints should be taken apart and re-sealed and re-tested.

Lightning Conductors

Under no circumstances should rainwater downpipes be used as a lightning conductor to earth. If bonding pipes to a lightning conductor system is required, the specialist installer must use an electrolytically compatible external bonding strap and not drill and bolt through the pipe wall.

Gutter outlet / Hopper connection

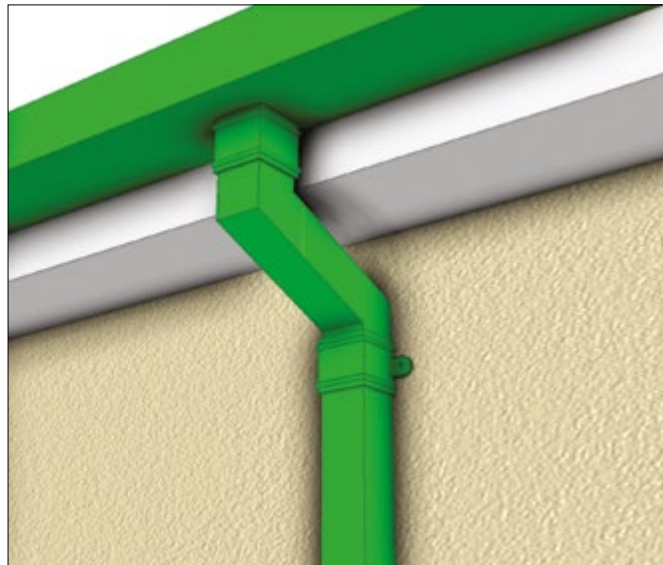

Fixing

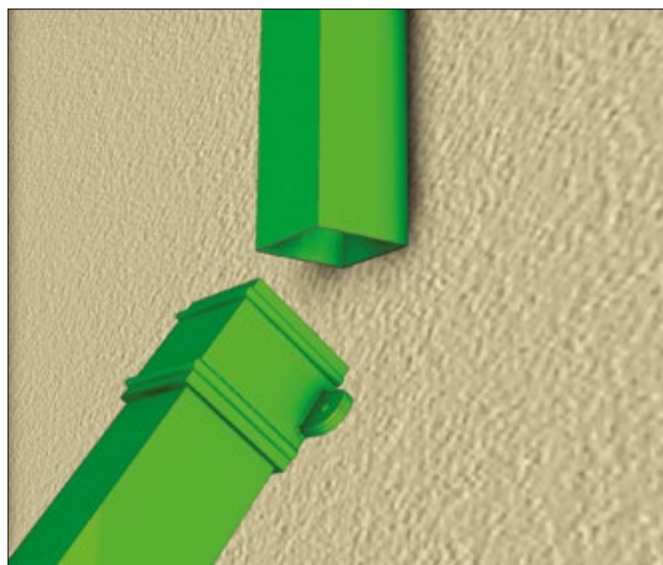

Drain Connection

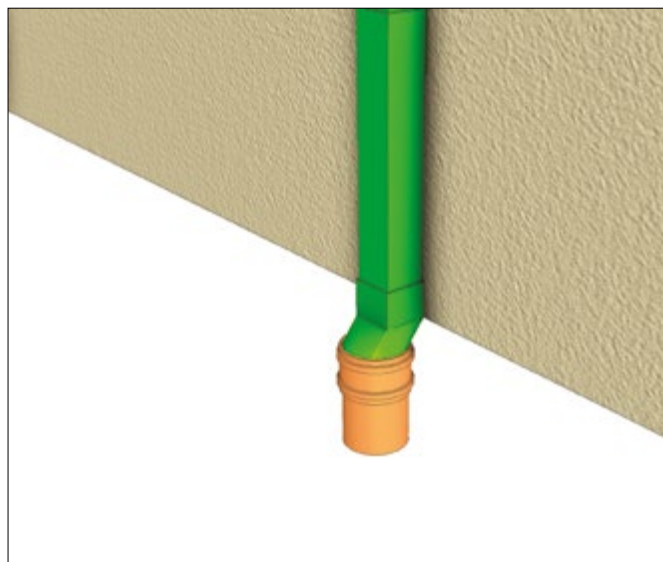

Gutter outlet / Hopper connection

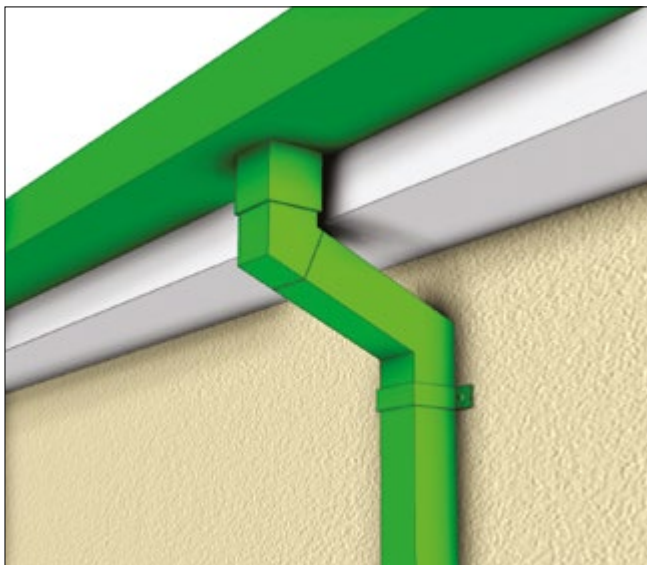

Fixing

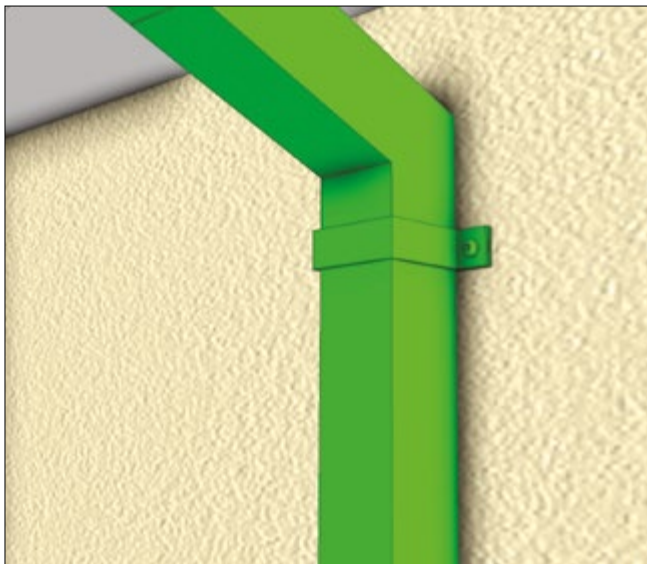

Drain Connection

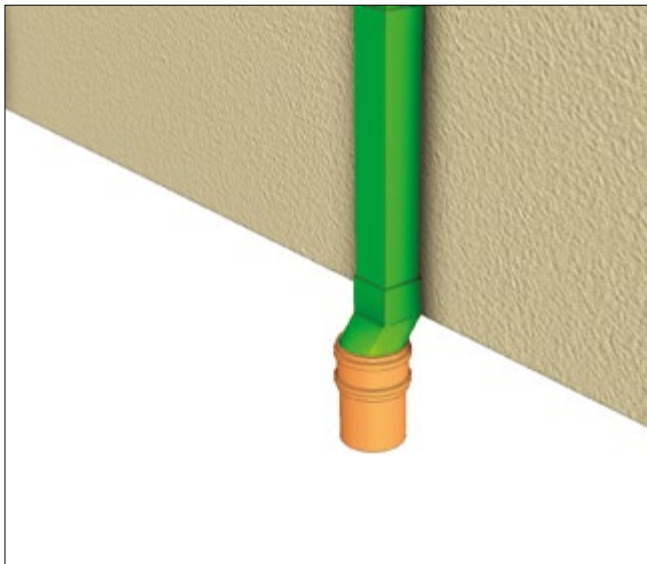

General Guidance

Gutter outlet / Hopper connection

Connection to the gutter outlet and or hopper is made via a pipe socket. Pipe sockets are supplied with all adjustable eaves offsets. Bespoke offsets can be made to order.

Fixing

For fixing to masonry, use the standard pipe clips and fix with Alutec No. 12 x 50mm domehead screw, code SC205 with appropriate wall plugs. One clip to be located over the pipe joint and a further clip 1.5 metres below. Additional pipe clips must be fitted adjacent to inline bends and branches.

Additional spacing from wall

Downpipes can be spaced out a further 30mm from the wall by using Alutec cast spacer bobbins with No. 16 x 100mm hex insert domehead, code SC209 with appropriate wall plugs.

If fixing to a non masonry background, please call Alutec Technical Services Department for advice.

Jointing

Joint sealing must not be carried out in wet weather or in temperatures below 5°C or above 40°C. Joint surfaces must be perfectly clean and dry. Use a clean cloth and Alutec solvent cleaner, code SC108 to remove all traces of dirt or grease, which may not be visible.

Joints to the gutter outlet connection and joints not on a vertical plane should always be sealed with Alutec sealant, code SC101; remaining joints do not require sealing.

Pipe off cuts can be utilised by fitting an internal joint spigot to a square cut end of pipe and sealed with Alutec sealant.

Drain Connection

Circular pipe

Unless a shoe is used to terminate the downpipe and discharge over an open gully, drain connections should preferably be made using an appropriate adaptor by the drain pipe manufacturer, e.g. connect to vitreous clay or PVCu drainage pipes with a universal EPDM rubber adaptor. For connection to cast iron drainage use a proprietary cast iron step coupling.

Square pipe

Unless a shoe is used to terminate the pipe and discharge over an open gully, drain connections should preferably be made using the appropriate size Alutec square to round drain connector. The adaptor push-fits inside a 110mm Ø ring sealed drain socket. The deep square connection socket allows for an insert and lift slip connection of the bottom pipe between two fixed points.

Testing

It is good practice to water test the downpipes after installation. If connected to a gutter system the discharging of flood test water from the gutter should identify any leaks within the downpipe system. For downpipes connected to hoppers or flat roof outlets, discharging water at the top with a hose pipe for a period of 5 minutes under normal mains pressure should suffice. Any leaking joints should be taken apart and re-sealed and re-tested.

Lightning Conductors

Under no circumstances should rainwater downpipes be used as a lightning conductor to earth. If bonding pipes to a lightning conductor system is required, the specialist installer must use an electrolytically compatible external bonding strap and not drill and bolt through the pipe wall.

General Guidance

Gutter outlet / Hopper connection

Connection to the gutter outlet and or hopper is made via a pipe socket. Pipe sockets are supplied with all adjustable eaves offsets. Bespoke offsets can be made to order.

Fixing

Unlike other pipes assemblies, this system is designed to be anti-climbable and therefore fixed flat against the wall with all support fixings concealed. Install in sequence from top to bottom using Alutec 50mm x No.12 countersunk screw, code SC241 with appropriate wall plugs. Unless used for the aesthetic value of the pipe system, shoes at the bottom of the pipes are not recommended. Bends and branches are supplied with loose fixing plates and fixing kit, to allow the plates to be fitted to the required left/right handing orientation.

If fixing to a non masonry background, please call Alutec Technical Services Department for advice.

Jointing

Joint sealing must not be carried out in wet weather or in temperatures below 5°C or above 40°C. Joint surfaces must be perfectly clean and dry. Use a clean cloth and Alutec solvent cleaner, code SC108 to remove all traces of dirt or grease, which may not be visible.

All pipe joints, including connection to the gutter outlet, must be sealed with Alutec sealant, code SC101. Ensure to allow a 3-4mm expansion gap between pipe lengths.

Pipe off-cuts can be used by fitting a pipe socket into a square cut end of pipe.

Drain Connection

Unless a shoe is used to terminate the pipe and discharge over an open gully, drain connections should preferably be made using the appropriate size Alutec square to round drain connector. The adaptor push-fits inside a 110mm Ø ring sealed drain socket. The deep square connection socket allows for an insert and lift slip connection of the bottom pipe between two fixed points.

Testing

It is good practice to water test the downpipes after installation. If connected to a gutter system the discharging of flood test water from the gutter should identify any leaks within the downpipe system. For downpipes connected to hoppers or flat roof outlets, discharging water at the top with a hose pipe for a period of 5 minutes under normal mains pressure should suffice. Any leaking joints should be taken apart and re-sealed and re-tested.

Lightning Conductors

Under no circumstances should rainwater downpipes be used as a lightning conductor to earth. If bonding pipes to a lightning conductor system is required, the specialist installer must use an electrolytically compatible external bonding strap and not drill and bolt through the pipe wall.

Gutter outlet / Hopper connection

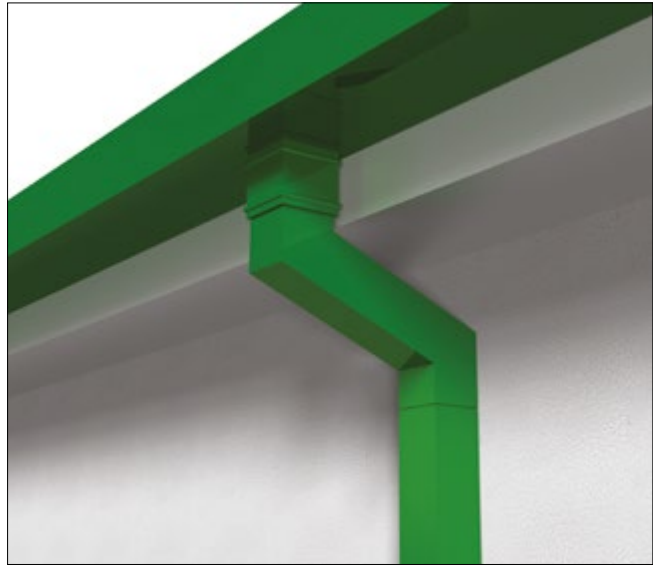

Fixing

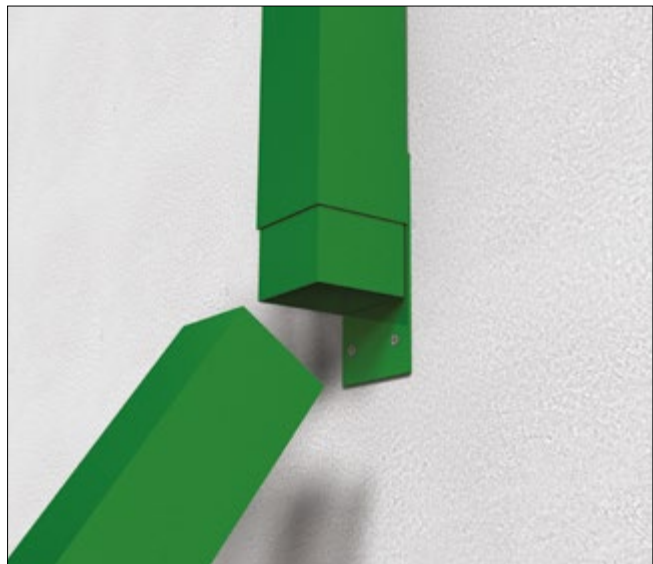

Drain Connection

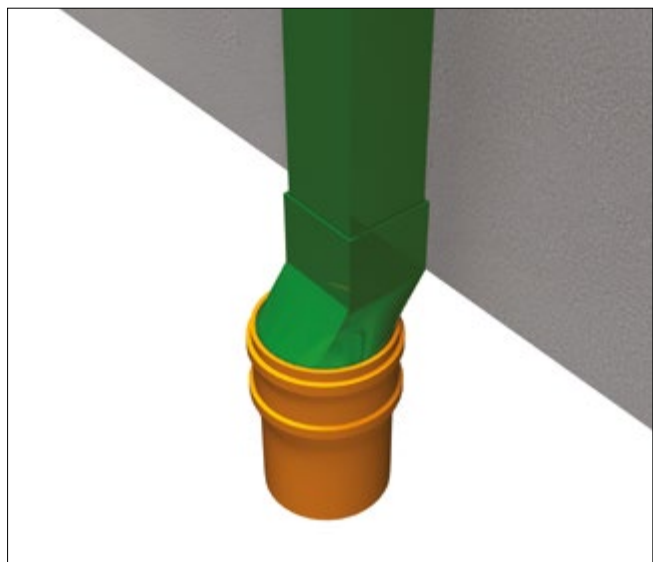

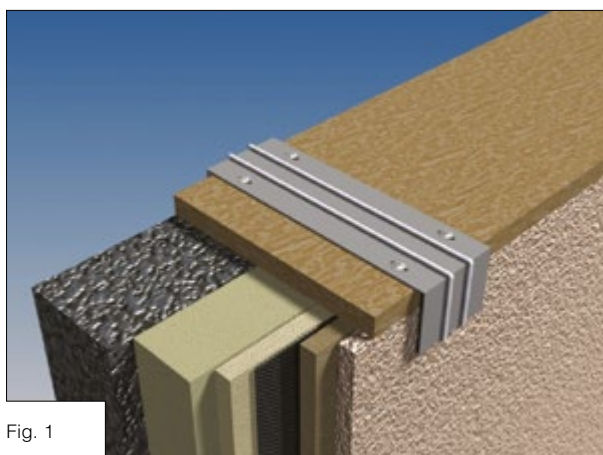

Fig. 1

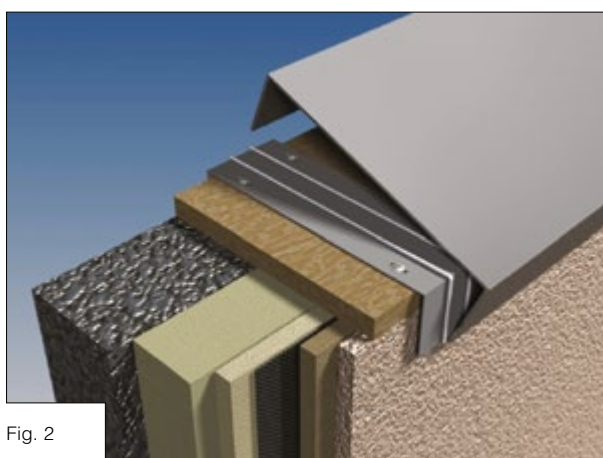

Fig. 2

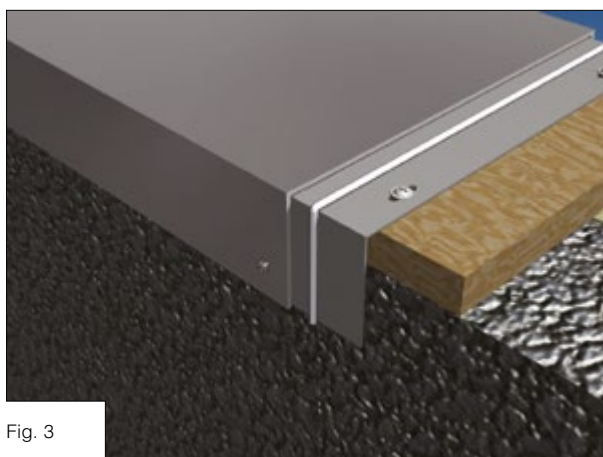

Fig. 3

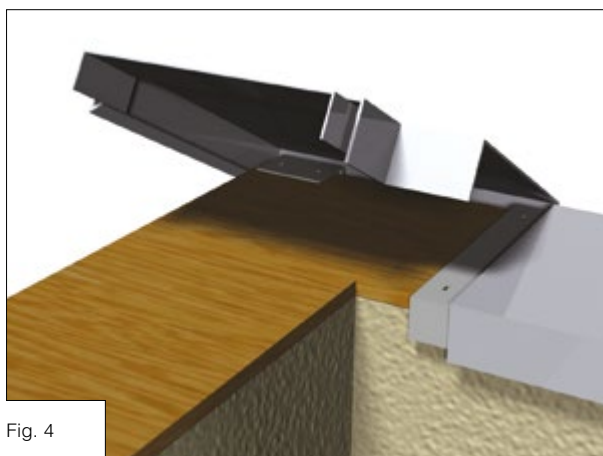

Fig. 4

General Guidance

Fixing Backgrounds

To achieve a strong, secure and flat surface onto which the copings can be fixed, we strongly recommend that the top of the parapet wall is lined with a minimum 22mm thick marine grade plywood backing board. The backing board should be the width of the parapet wall and be securely fixed to withstand wind load forces. Ensure the backing board is fixed level, as any deviations will manifest themselves in the overall appearance of the installed coping.

1. Fig. 1

Fixing brackets must be located centrally at each coping joint abutment and spaced at maximum 1.5m centres. Secure each bracket using 4 no. No. 8 x 25mm flangehead screws, code SC204.

Optional

If required, the coping system can be laid to a fall of 2° or less by placing glazing shims (supplied by others) underneath the Fixing brackets.

2. Fig. 2

Offer coping panel into place by hooking the front drip edge over the fixing brackets. Remove butyl tape liner, then rotate panel downwards until in its resting position. Press the coping panel down firmly over entire bracket to ensure full contact is made with the high performance butyl sealing strips.

3. Fig. 3

In line with each bracket, on the inside return face pre-drill a 3.5mmØ hole through the coping panel and bracket. Insert No. 8 x 15mm colour matched flangehead screw, code SC250. Before fitting next coping section, repeat steps 1 and 2, then offer coping panel into position ensuring a 3mm expansion gap is left between abutting ends. Fix coping panel into position as step 3.

4. Fig. 4

Remove butyl tape and attach one full fixing bracket to one side of the coping angle. A 1/2 fixing bracket must be secured to the fixing background using 2 x SC204 screws as shown in Fig. 4. Position the angle in place ensuring the returns on the downstands engage with the coping length bracket and 1/2 bracket. Fix down remaining exposed full bracket with 2 x SC204 screws. Using SC250 (No.8 x 15mm) colour matched screws, fix through inside return faces into the brackets to anchor into position.

Further information and advice

If you have any queries, please contact The Alutec Technical Services Department on 01234 344108.

Soffit installation:

Step 1:

Each soffit or fascia panel's protective film is printed with directional arrows. Ensure panels are fixed with the arrows pointing in the same direction to ensure a uniform surface appearance. Remove a small area of the protective film from the locations of all fixings to prevent it being trapped underneath the head of the fixing. See Fig. 1

Step 2:

Fix Soffit support trim FF30 to background at 600mm centres and slot soffit panel into Soffit support trim FF30. Pre-drill pilot holes and fix soffit at 600mm centres in rafter / truss ends with colour matched polypins, code SC670 at the front. Polypins should be positioned to be concealed by the bottom front return edge of the fascia. See Fig. 2

Step 3:

Joints between abutting panels are made using 'H' section joint trims. See Fig. 2

Step 4:

Install next soffit panel; ensure a 4mm expansion gap between panels. Fix horizontal timber battens between rafters / trusses for support and alignment at joints.

Fig. 1

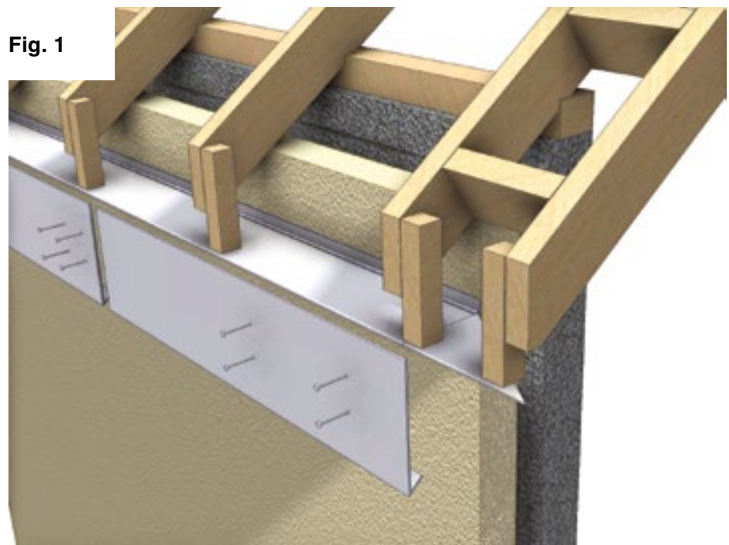

Fixing - Maximum 600mm centres

Fig. 2

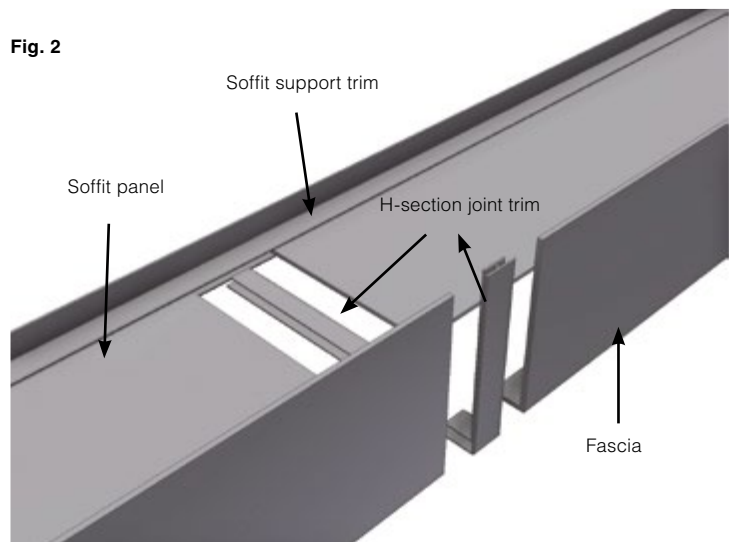

Jointing - Straight sections

Fig. 3

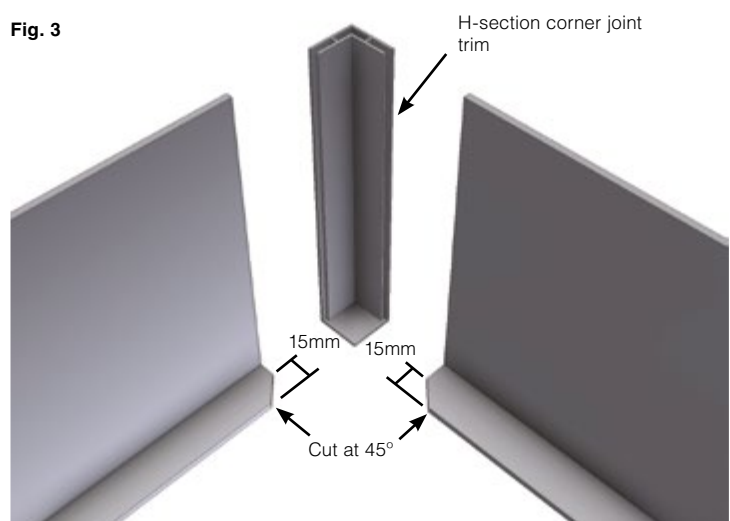

Angle joint - Cut fascia returns 15mm from front face at 45°

Fascia installation option 1: Mechanical fixing

Step 4.1: Option

Direct fixing to rafters: For fascia panels supporting guttering, fix with two Nr 50mm poly nails SC280 above the gutter line at maximum 600mm centres. For fascia panels not supporting guttering, fix with two Nr 30mm polypins SC670 at maximum 600mm centres. Additional polypin fixings will be required for fascias over 250mm deep.

Step 4.2: Option

Fixing to timber background: Fix fascia panel at maximum 600mm centres with two Nr 30mm polypins SC670 above the gutter line.

Step 5:

Abutting ends must be jointed with the appropriate H-Section joint trim.

Step 6:

Ensure there is at least a 2mm expansion gap where fascia panel is inserted into the H-section joint trim.

Step 7:

Finally, remove the protective film within 90 days of installation.

Fig. 4

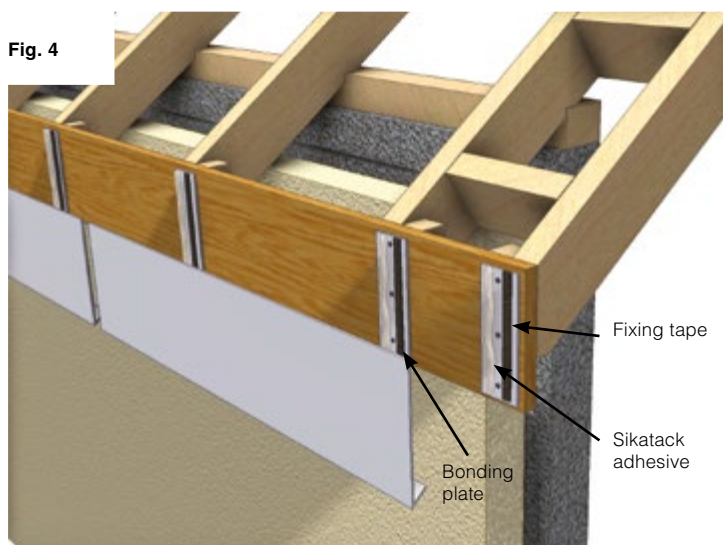

Bonding fascia option - Plates at maximum 600mm centres

Fig. 5

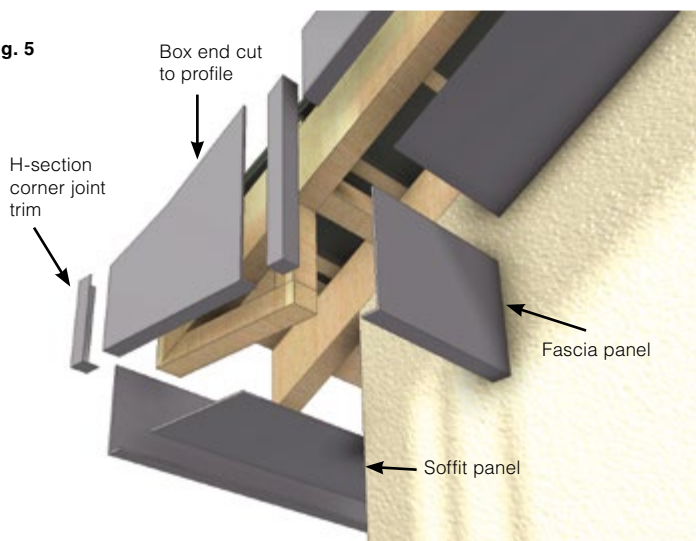

Typical box end construction

Fig. 6

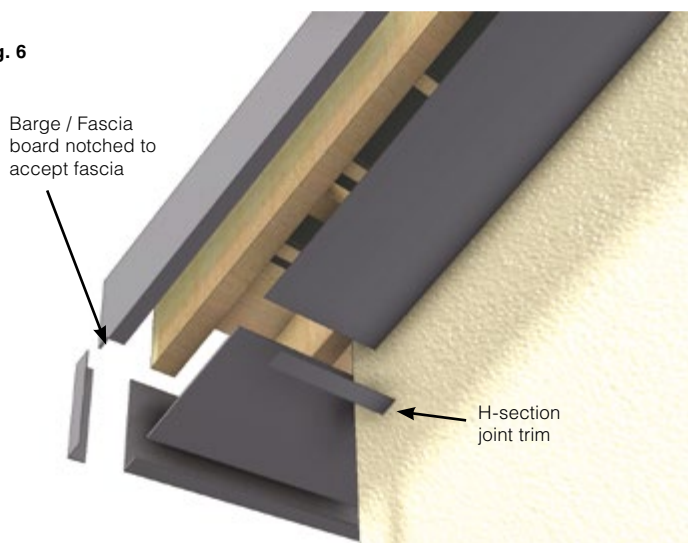

Angled soffit box end construction

Fascia installation option 2: Bonding

Marley Alutec recommends the use of SikaTack Panel Adhesive System when bonding panels.

Not all backgrounds are suitable for a direct secure bond, therefore bonding plates should be mechanically fixed to the background at maximum 600mm centres. Bonding plates are supplied 75mm wide in 3m lengths code FY40 for site cutting to required lengths.

Step 8:

Fix bonding plate FY40 at 600mm centres using minimum 3 Nr stainless steel flat head annular nails or countersunk screws.

Step 9:

Strip off the protective film from the bonding plates and apply one thin coat of SikaTack panel primer to the bonding plates and corresponding areas to the rear of the fascia board. Allow at least 30 minutes for the primer to dry.

Step 10:

Apply the self-adhesive fixing tape vertically to the full length of the bonding plate 5mm in from the edge. This fixing tape is only intended to hold the panel in position until the adhesive is fully cured. See Fig. 4.

Step 11:

Apply SikaTack adhesive to the bonding plate using the triangular nozzle supplied, applying a 10mm high bead at least 5mm from the edge of the plate.

Important Note: Do not apply adhesive in damp/wet conditions or temperatures below 5°C. We also recommend discreet pinning to the top edge to support the weight of the panels as an additional safety measure.

Step 12:

Remove the foil from the fixing tape, and then carefully offer the fascia panel into the required position to make contact with the beads of adhesive, but without touching the fixing tape. When the panel is in position, press firmly until it makes contact with the fixing tape. We recommend this operation is carried out by two operatives. Fitting the panel must be completed within 10 minutes after application of the adhesive.

Step 13.1: Option

H Section Joints: Abutting ends must be jointed with the appropriate H-Section joint trim.

Step 13.2: Option

Pointed Joints: To achieve a neat silicone joint apply masking tape to both edges, point silicone into the joint, code SC103 and smooth flat. Note: Silicone must make contact with the rear bonding plate. Finally remove masking tape.

Step 14:

Finally, remove the protective film within 90 days of installation.

Soffit installation:

Note:

All adjoining surfaces on Fascia and Soffit to be thoroughly cleaned with solvent cleaner (SC108) prior to silicone sealing.

Step 1:

Pre drill 2 parallel rows of 5mm pilot holes in the Soffit at 600mm centres along the panel length. If the Soffit width is greater than 600mm then a minimum 3 rows of screws are required.

Offer up the Soffit and screw to pre-fitted 18mm thick marine grade plywood backing board with SC675 screws (Fig. 1)

If using Type A or Type C Fascia, the front row of screws can be positioned to be concealed by the bottom front return edge of the fascia.

Step 2:

Joints between abutting Soffit panels are made with internal joint trims (Fig. 2).

To fit the the joint trims, apply a bead of silicone sealant along the length of one side of the joint trim and slide into position under the already fitted Soffit panel.

Step 3:

Install the next Soffit panel using the same process as in Step 1. Apply a bead of silicone sealant to the exposed side of the Joint trim before fitting the next soffit. Ensure a 4mm expansion gap between the panels. Continue along the length of the building repeating steps 1 to 3.

Fig. 1

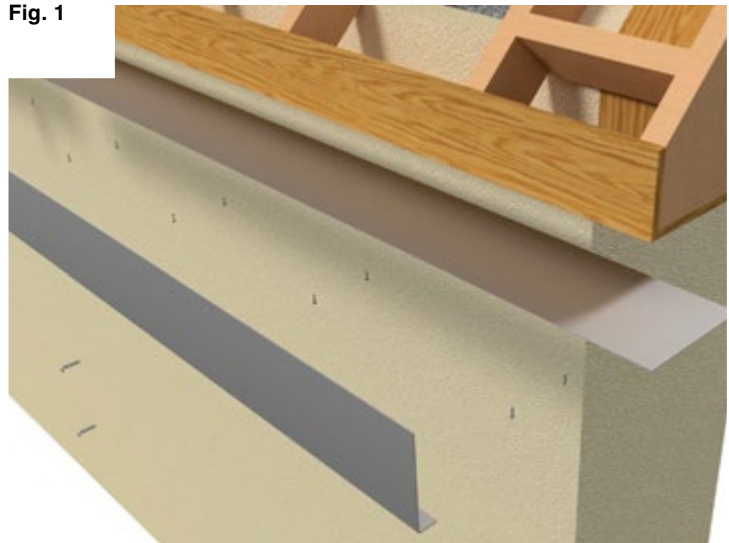

Fixing - Maximum 600mm centres

Fig. 2

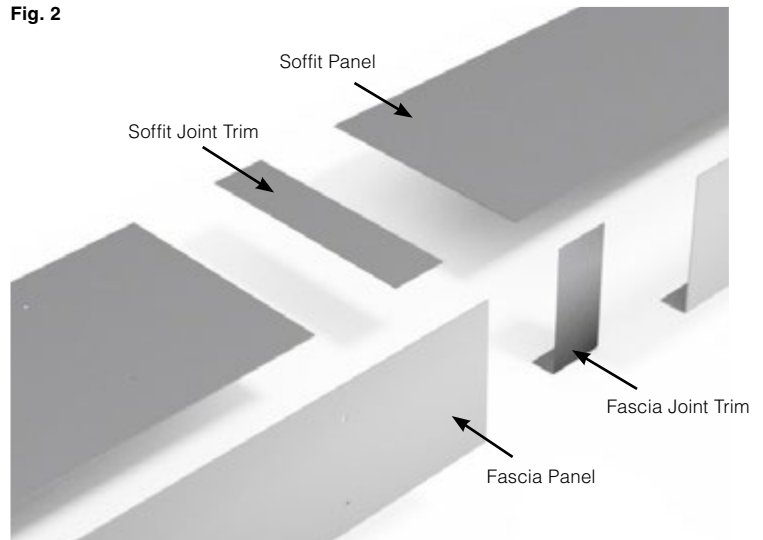

Jointing - Straight sections

Fig. 3

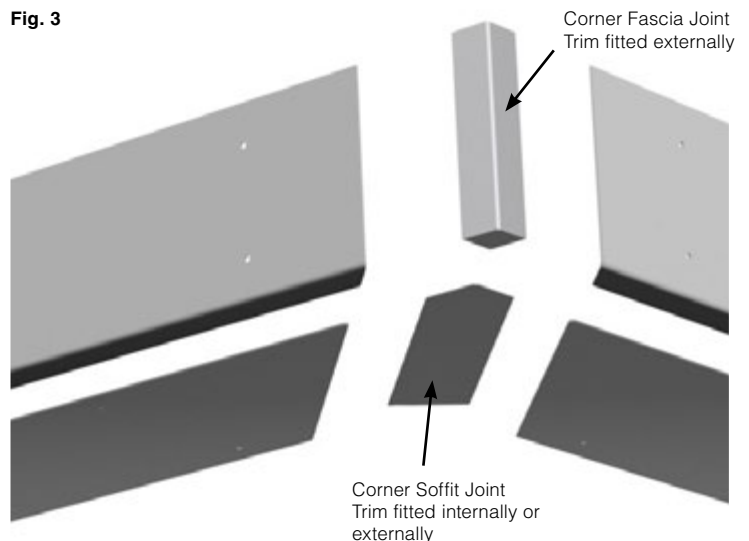

Jointing - Corner Detail

Fascia Panel Installation

Step 4:

Pre drill 2 parallel rows of 5mm pilot holes in the Fascia at 600mm centres. If Fascia width is over 600mm then a minimum 3 rows of screws are required. For Fascia panels supporting guttering the top row should be drilled above the gutter line. Offer up Fascia and screw to pre-fitted 18mm thick marine grade plywood backing board with SC675 screws (Fig. 1.)

Step 5:

Joints between abutting Fascia panels are made with internal joint trims (Fig. 2).

To fit the the joint trims, apply a bead of silicone sealant along the length of one side of the joint trim and slide into position under the already fitted Fascia panel.

Step 6:

Install next Fascia panel using the same process as in Step 4. Apply a bead of silicone sealant to the exposed length of the Joint trim before fitting the next Fascia. Ensure a 4mm expansion gap between the panels. Continue along the length of the building repeating steps 4 to 6.

Step 7:

The fascia corner trim is fitted externally. Clean faces using solvent cleaner and cut to size if needed. Apply a bead of silicone sealant to the rear faces of the trim and press into position on the fascia. Temporarily hold in place with low tack masking tape. Remove when sealant has cured (Fig. 3)

The joint trim for the soffit can be fitted internally or externally.

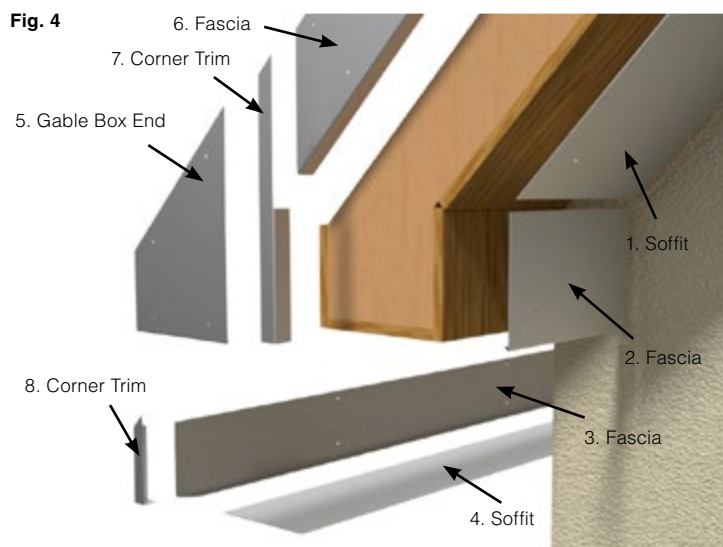

Typical box end construction

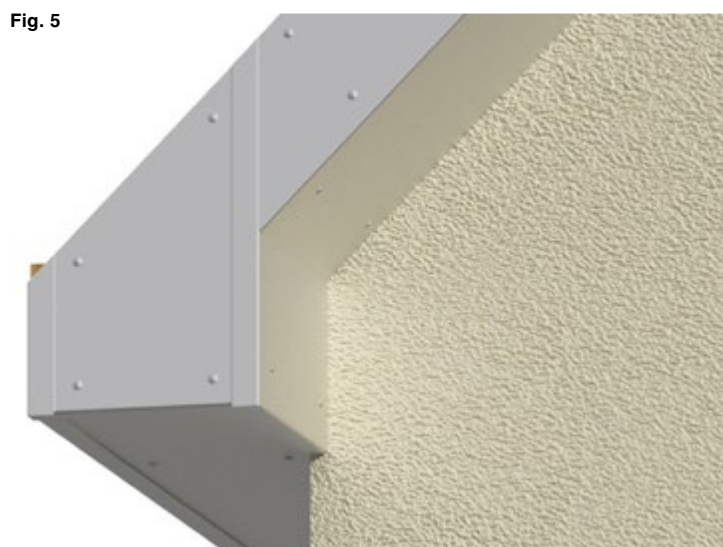

Completed typical box end



Angled soffit box end construction

Box End Installation

Step 1:

On Fascia (3) cut/mitre the small return fold at 45 degrees. Install Fascia (3) and Soffit (4) as per above Fascia & Soffit installation instructions.

Step 2:

Pre-drill Soffit (1) with 2 parallel rows of 5mm pilot holes at 600mm centres along the panel length. If the Soffit width is greater than 600mm then a minimum 3 rows of screws are required.

Offer up Soffit and screw to pre-fitted 18mm thick marine grade plywood backing board with SC675 screws.

If using Type A or Type C Fascia, the front row of screws can be positioned to be concealed by the bottom front return edge of the fascia.

Step 3:

Measure and cut a piece of Fascia (2) to length. Cut/mitre the small return fold at 45 degrees where it meets the box end (5). Depth of Fascia may also need to be cut to suit. Pre-drill holes as in step 2. Offer up Fascia and screw to pre-fitted 18mm thick marine grade plywood backing board with SC675 screws.

Step 4:

On the gable box end (5) mark the roof angle and cut/mitre the part to suit. Cut/mitre the small return fold at 45 degrees on both ends where it meets Fascia (2) & (3).

Pre-drill holes as in step 2. Offer up Fascia and screw to pre-fitted 18mm thick marine grade plywood backing board with SC675 screws.

Step 5:

On Fascia (6) mark the roof angle and cut/mitre the end of the panel.

Pre-drill holes as in step 2. Offer up Fascia and screw to pre-fitted 18mm thick marine grade plywood backing board with SC675 screws.

Step 6:

Offer up corner trims (7 & 8), mark the roof angle and lengths. Cut/mitre the trims to size.

Apply a bead of silicone sealant to the insides of the trims and press into position. Temporarily hold in place with low tack masking tape. Remove when sealant has cured.

Step 7:

Touch up all cut edges with the supplied touch up paint.

IMPORTANT:

Common installation tasks applicable to all installations

- Fit threaded pipe connector into the outlet body as per the label attached to each threaded pipe connector, **using silicone sealant (SC101)**.
- Fill any structural voids to the underside of the outlet with mortar or insulation as appropriate.
- Fit a fire collar or wrap around the protruding plastic pipe against the underside of the roof structure, if the pipe projects into a building

Cold Roofs and Car Parks

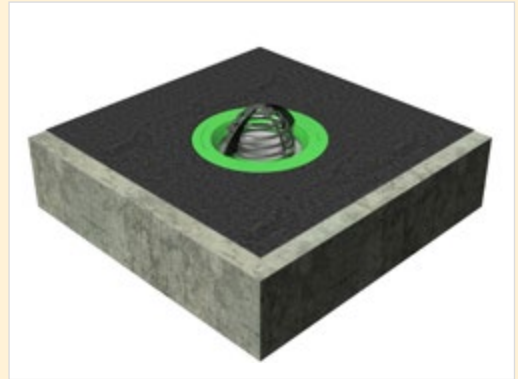
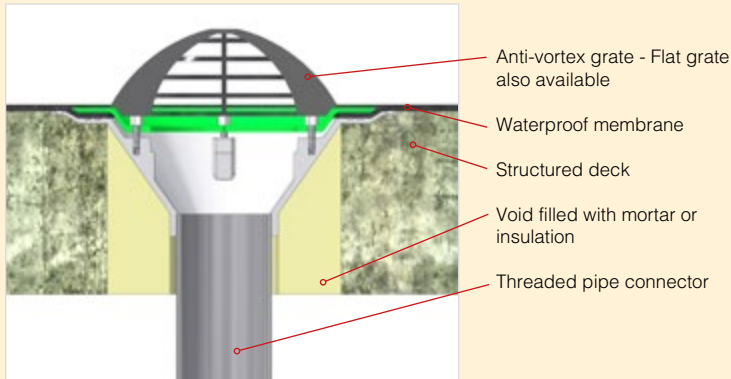

GRP, Cold Liquid, Hotmelt or Asphalt Waterproofing Membranes

1. Remove the membrane clamp ring, wax paper ring including butyl seals & three foam transit spacers located within the throat of the outlet and discard.
2. Place roof outlet body (with pipe connector fitted) centrally over structural opening.
3. Dress/apply waterproofing membrane over the recessed grooves of the outlet body.
4. Place membrane clamping ring over waterproofing membrane, then secure to outlet body with the 4 Nr male/female insert bolts. (Use the 4 threaded rods and belts supplied for asphalt applications) Tighten bolts in a diagonal sequence to ensure even compression. Check tightness after 15-30 mins and further tighten if required.
5. Attach grating.

Sheet Waterproofing Membranes

1. Remove the dome/flat grate, membrane clamp ring & wax paper ring from the butyl seal rings, including three foam transit spacers located within the throat of the roof outlet.
2. Place roof outlet body with pipe connector fitted, centrally over structural opening.
3. Cut a 500mm square piece of the waterproofing membrane with a 220mm diameter hole in the centre and place centrally over roof outlet.
4. Place membrane clamping ring over waterproofing membrane, then secure to outlet body with 4 Nr male/female insert bolts. Tighten bolts in a diagonal sequence to ensure even compression. Check tightness after 15-30 mins and further tighten if required.
5. Attach grating.

Warm Roofs

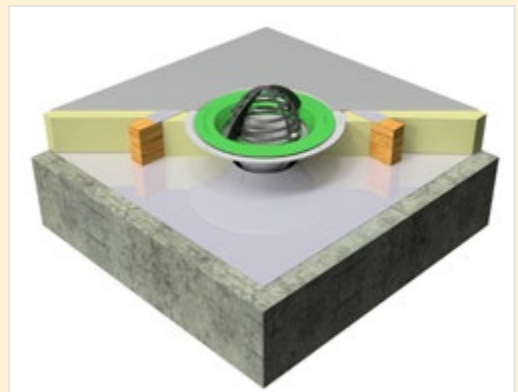
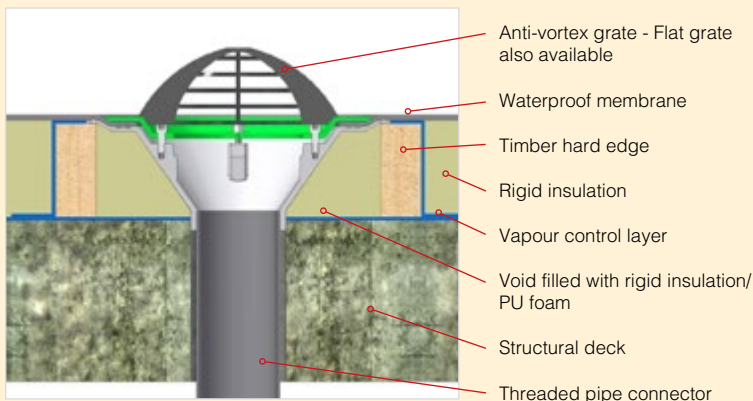

Sheet Waterproofing Membranes

1. The vapour control layer should be cut and sealed around the downpipe hole, within the deck, in accordance with the manufacturer's instructions.
2. Create a 340x340mm internal dimension timber or other suitable material kerb around the roof outlet structural opening to the same height as the insulation.
3. Flashing pieces of the vapour control layer should be dressed over the timber kerb and sealed to the main vapour control layer.
4. Place roof outlet onto the raised kerb, mark and recess the four contact areas so the top of the roof outlet and insulation are at the same height, then secure with 4 Nr A2 stainless steel screws (not supplied).
5. Cut rigid sections of insulation to infill the corners of the timber kerb.
6. Cut a 500mm square piece of the waterproofing membrane with a 220mm diameter hole centrally.
7. Remove the dome/flat grate, membrane clamp ring & wax paper ring from the butyl seal rings, including three foam transit spacers located within the throat of the roof outlet.
8. Place the 500mm square piece of waterproofing membrane over the outlet body ensuring the 220mmØ hole is central.
9. Place the membrane clamping ring over the waterproofing membrane, then secure to outlet body with 4 Nr male/female insert bolts. Tighten bolts in a diagonal sequence to ensure even compression. Check tightness after 15-30 mins and further tighten if required.
10. Attach grating.

Inverted Ballast Roof

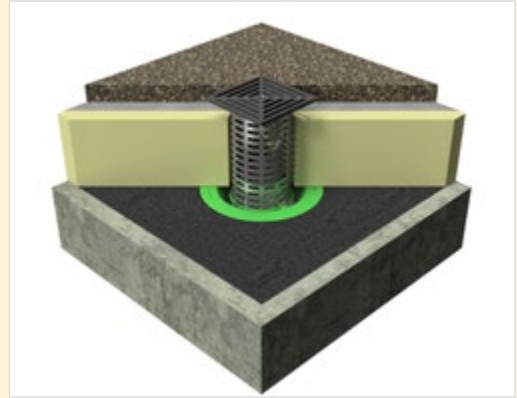
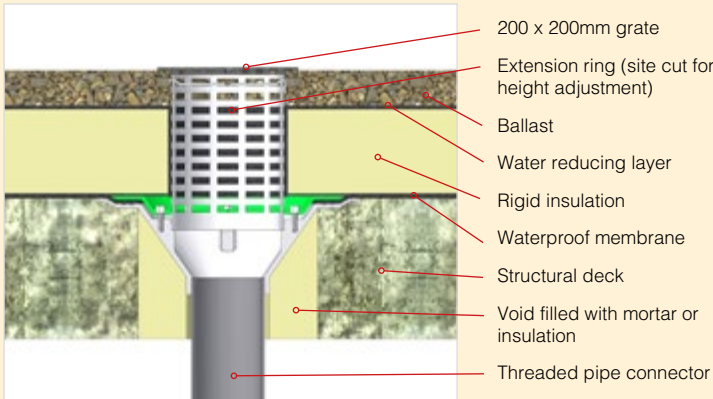

Inverted Paved Roof (Terrace)

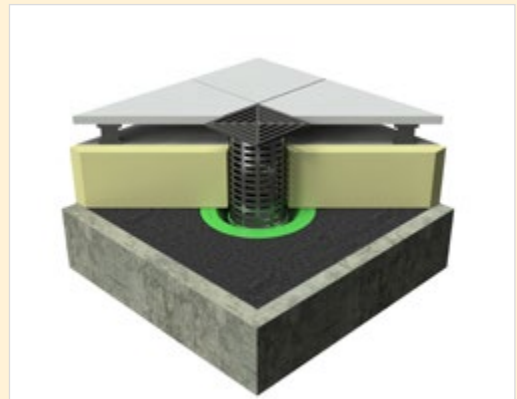
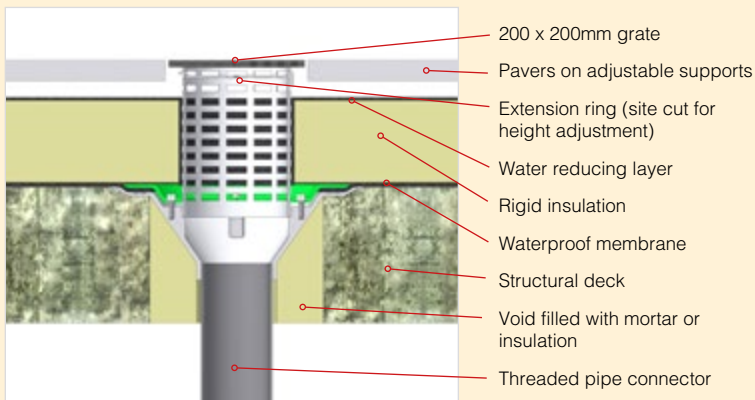

Green Roof

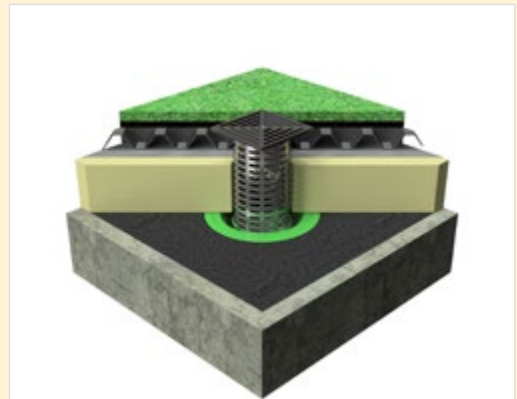
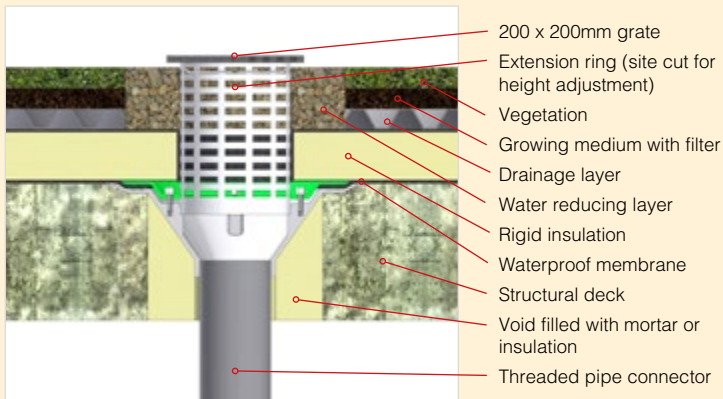

GRP, Cold Liquid and Hotmelt Waterproofing Membranes

1. Remove the membrane clamp ring, wax paper ring including butyl seals & three foam transit spacers located within the throat of the balcony outlet and discard.
2. Place roof outlet body with pipe connector fitted centrally over structural opening
3. Dress/apply waterproofing membrane over the recessed grooves of the outlet body.
4. Place membrane clamping ring over waterproofing membrane, then secure to outlet body with the 4 Nr male/female insert bolts. Tighten bolts in a diagonal sequence to ensure even compression. Check tightness after 15-30 mins and further tighten if required.
5. Insert the 160mmØ perforated extension into outlet throat. Place PIR insulation around the perforated extension. Cut the 160mmØ perforated extension to the required height (level with the finish top layer).
6. Remove perforated extension ring and dress the water runoff layer into the insulation void, then re-insert the perforated extension ring.
7. Insert the grate retaining bar through the uppermost perforations so that the threaded fixing hole is central. Place the 200 x200mm square grating into position and secure with screw provided.
8. Apply any further roof build-up components and dress around the outlet extension ring.

Sheet Waterproofing Membranes

1. Remove the membrane clamp ring. Remove the wax paper ring from the butyl seal rings including three foam transit spacers located within the throat of the roof outlet, and discard.
2. Place roof outlet body with pipe connector fitted centrally over structural opening.
3. Cut a 500mm square piece of the waterproofing membrane with a 220mm diameter hole in the centre and place centrally over roof outlet.
4. Place membrane clamping ring over waterproofing membrane, then secure to outlet body with 4 Nr male/female insert bolts. Tighten bolts in a diagonal sequence to ensure even compression. Check tightness after 15-30 mins and further tighten if required.
5. Insert the 160mmØ perforated extension into outlet throat. Place PIR insulation around the perforated extension. Cut the 160mmØ perforated extension to the required height (level with the finished top layer).
6. Remove perforated extension ring and dress the water runoff layer into the insulation void, then re-insert the perforated extension ring.
7. Insert the grate retaining bar through the uppermost perforations so that the threaded fixing hole is central. Place the square grating into position and secure with screw provided.
8. Apply any further roof build-up components and dress around the outlet extension ring.

Blue Roof

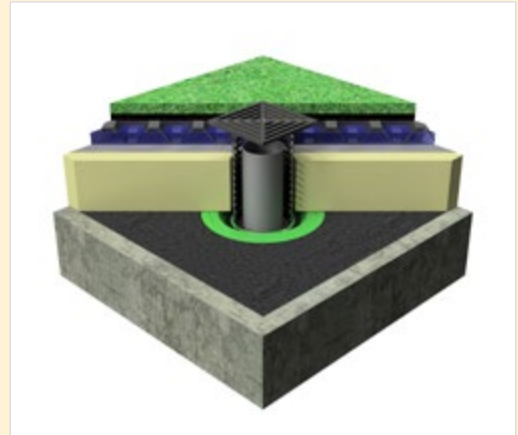
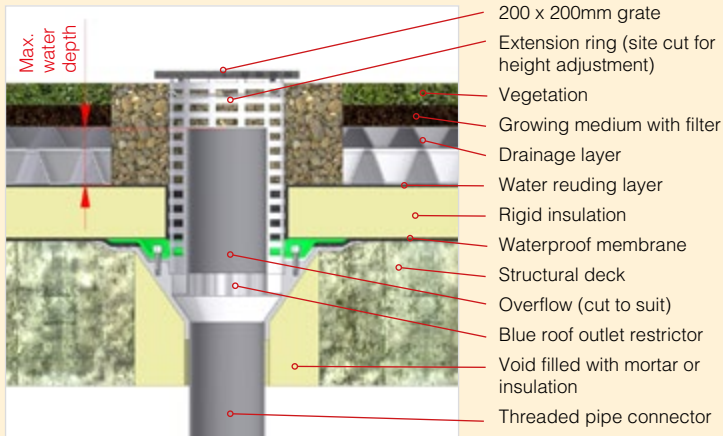

GRP, Cold Liquid, Hotmelt Waterproofing Membranes

1. Remove the membrane clamp ring, wax paper ring including butyl seals & three foam transit spacers located within the throat of the outlet and discard.
2. Place roof outlet body with pipe connector fitted centrally over structural opening
3. Dress/apply waterproofing membrane over the recessed grooves of the outlet body.
4. Place membrane clamping ring over waterproofing membrane, then secure to outlet body with the 4 Nr male/female insert bolts. Tighten bolts in a diagonal sequence to ensure even compression. Check tightness after 15-30 mins and further tighten if required.
5. Insert the 160mmØ perforated extension into outlet throat. Place PIR insulation around the perforated extension. Cut the 160mmØ perforated extension to the required height.
6. Remove perforated extension ring and dress the water runoff layer into the insulation void, then re-insert the perforated extension ring.
7. Place Blue Roof restrictor/overflow flange into the throat of the outlet body. Establish the maximum allowable water depth, mark and cut the overflow upstand to correspond accordingly.
8. Place and bed the flange of the Blue Roof restrictor onto an 8mm bead of silicone into the throat of the roof outlet.
9. Remove correct number of restrictor sealing plugs as instructed within the Blue Roof drainage design.
10. Re-insert the perforated extension ring. Insert grate retaining plate and fix square grating into position with screw provided.
11. Apply any further roof build-up components and dress around the outlet extension ring.

Sheet Waterproofing Membranes

1. Remove the membrane clamp ring. Remove the wax paper ring from the butyl seal rings including three foam transit spacers located within the throat of the roof outlet, and discard.
2. Place roof outlet body with pipe connector fitted centrally over structural opening.
3. Cut a 500mm square piece of the waterproofing membrane with a 220mm diameter hole in the centre and place centrally over roof outlet.
4. Place membrane clamping ring over waterproofing membrane, then secure to outlet body with 4 Nr male/female insert bolts. Tighten bolts in a diagonal sequence to ensure even compression. Check tightness after 15-30 mins and further tighten if required.
5. Insert the 160mm perforated extension into outlet throat. Place PIR insulation around the perforated extension. Cut the 160mm perforated extension to the required height.
6. Remove the perforated extension ring and dress the water runoff layer into the insulation void.
7. Place Blue Roof restrictor/overflow flange into the throat of the outlet body. Establish the maximum allowable water depth, mark and cut the overflow upstand to correspond accordingly.
8. Place and bed the flange of the Blue Roof restrictor onto an 8mm bead of silicone into the throat of the roof outlet.
9. Remove correct number of restrictor sealing plugs as instructed within the Blue Roof drainage design.
10. Re-insert the perforated extension ring. Insert grate retaining plate and fix square grating into position with screw provided.
11. Apply any further roof build-up components and dress around the outlet extension ring.

Parapet Outlet – Warm, cold and inverted roofs

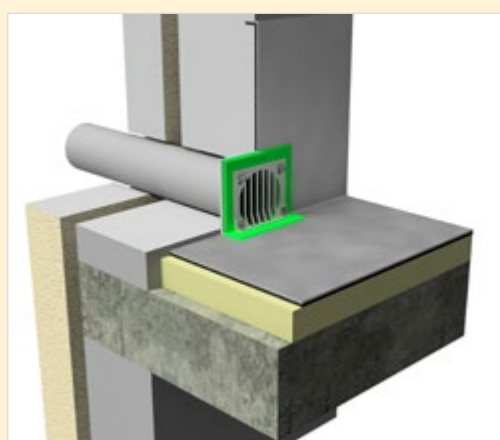
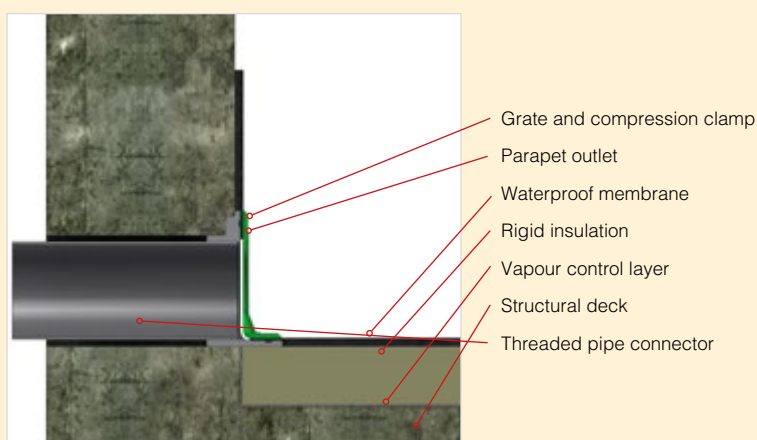
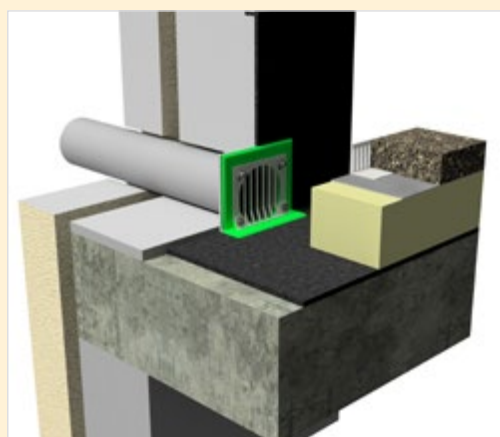
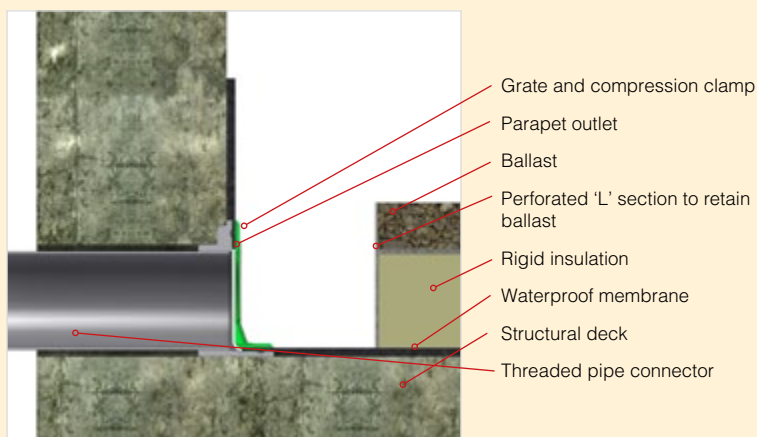

GRP, Cold Liquid, Hotmelt Waterproofing Membranes

1. Remove the L shaped membrane clamp flange & stainless-steel grate. Remove wax paper ring, butyl seal strips including three foam transit spacers located within the throat of the outlet and discard.
2. Insert roof outlet with pipe adaptor fitted, into the structural opening and secure with 2 Nr A2 grade stainless steel screws (not provided) into the vertical background.
3. Dress the waterproofing membrane over the recessed grooves of the outlet body.
4. Place L shaped membrane clamp flange and grate over waterproofing membrane, then secure to outlet body with the 4 Nr male insert bolts. Tighten bolts in a diagonal sequence to ensure even compression. Check tightness after 15-30 mins and further tighten if required.

Sheet Waterproofing Membranes

1. Remove the L shaped membrane clamp flange & stainless-steel grate, wax paper ring from butyl seal ring including three foam transit spacers located within the throat of the roof outlet.
2. Insert roof outlet with pipe adaptor fitted, into the structural opening and secure with 2 Nr A2 grade stainless steel screws (not provided) into the vertical background.
3. Create a 500mm sq. skirt from the waterproof membrane and cut a 90x112mm rectangular hole in the middle and place over the outlet body & butyl seal strips.
4. Place L shaped membrane clamp flange and grate over waterproofing membrane, then secure to outlet body with the 4 Nr male insert bolts. Tighten bolts in a diagonal sequence to ensure even compression. Check tightness after 15-30 mins and further tighten if required.

Inverted roofs - A localised sump area/void, adjacent to the outlet, should be left within the insulation of approximately 200x200mm in size. The void area can be left open or backfilled with ballast.

Un-insulated Balconies

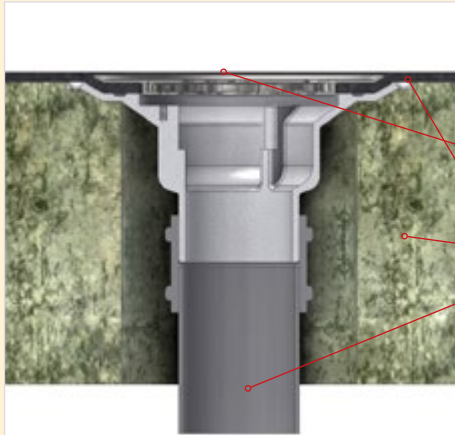

- Polished steel plate grate and compression clamp
- Waterproof membrane
- Structural deck
- Connecting pipework

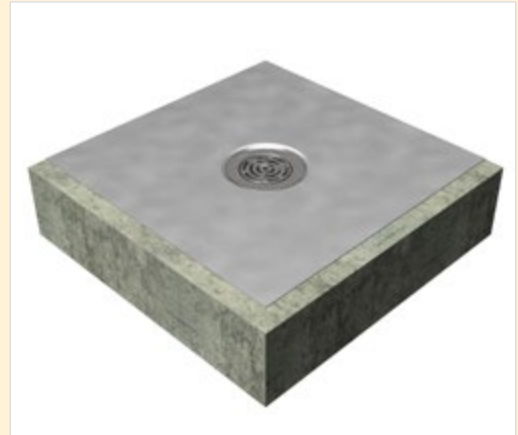

GRP, Cold Liquid and Hotmelt Waterproofing Membranes

1. Remove the membrane clamp ring, wax paper ring including butyl seals & three foam transit spacers located within the throat of the balcony outlet and discard.
2. Insert balcony outlet into the structural opening and secure with A2 grade stainless steel screws (not supplied).
3. Dress the waterproofing membrane over the recessed grooves of the outlet body
4. Place membrane clamping ring over waterproofing membrane, then secure to outlet body with the 3Nr bolts provided. Tighten bolts in a diagonal sequence to ensure even compression. Check tightness after 15-30 mins and further tighten if required.
5. Place circular grate over outlet and secure with screws provided.

Sheet Waterproofing Membranes

1. Remove the membrane clamp ring, wax paper ring, including three foam transit spacers located within the throat of the balcony outlet and discard.
2. Insert balcony outlet into the structural opening and secure with A2 grade stainless steel screws (not supplied).
3. Create a 500mm sq. skirt from the waterproof membrane and cut a 135mm diameter hole in the middle. Centralise skirt over the outlet body.
4. Place membrane clamping ring over waterproofing membrane, then secure to outlet body with the 3Nr bolts provided. Tighten bolts in a diagonal sequence to ensure even compression. Check tightness after 15-30 mins and further tighten if required.
5. Place circular grate over outlet and secure with screws provided.

Paved/Decked Balconies

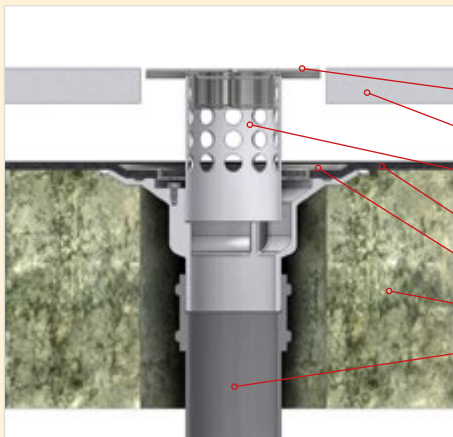

- Polished steel terrace grate
- Pavers on adjustable supports
- Extension ring (site cut for height adjustment)
- Waterproof membrane
- Compression clamp
- Structural deck
- Connecting pipework

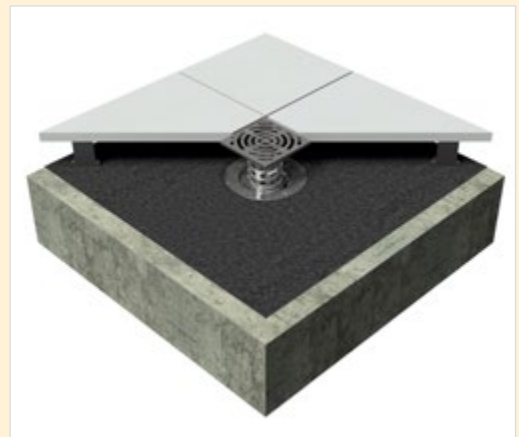

GRP, Cold Liquid and Hotmelt Waterproofing Membranes

1. Remove the membrane clamp ring, wax paper ring including butyl seals & three foam transit spacers located within the throat of the balcony outlet and discard.
2. Insert balcony outlet into the structural opening and secure with A2 grade stainless steel screws (not supplied).
3. Dress the waterproofing membrane over the recessed grooves of the outlet body
4. Place membrane clamping ring over waterproofing membrane, then secure to outlet body with the 3Nr bolts provided. Tighten bolts in a diagonal sequence to ensure even compression. Check tightness after 15-30 mins and further tighten if required.
5. Insert perforated extension into outlet throat then mark the required height and cut down accordingly (5mm below finished floor level).
6. Press square tile grate spigot into the perforated extension.

Sheet Waterproofing Membranes

1. Remove the membrane clamp ring, wax paper ring, including three foam transit spacers located within the throat of the balcony outlet and discard.
2. Insert balcony outlet into the structural opening and secure with A2 grade stainless steel screws (not supplied).
3. Create a 500mm sq. skirt from the waterproof membrane and cut a 135mm diameter hole in the middle. Centralise skirt over the outlet body.
4. Place membrane clamping ring over waterproofing membrane, then secure to outlet body with the 3Nr bolts provided. Tighten bolts in a diagonal sequence to ensure even compression. Check tightness after 15-30 mins and further tighten if required.
5. Insert perforated extension into outlet throat then mark the required height and cut down accordingly (5mm below finished floor level).
6. Press square tile grate spigot into the perforated extension.

General Information

Prices quoted are trade list prices and exclude Value Added Tax (VAT). Customer attention is drawn to the Company's official Terms and Conditions of Sale. Goods are supplied strictly in accordance with these terms and conditions, copies of which are freely available from our website.

Marley Alutec products are manufactured to a constant high standard. Marley Alutec will therefore not accept responsibility for failure of any installation which includes components not supplied by us. Only use Marley Alutec recommended sundries, as other products may be incompatible and impair the life expectancy of the system.

Before placing your order please check that you have ordered the appropriate amount of sealant, solvent cleaner, screws, nuts/bolts/washers and touch-up paints. Where applicable when ordering, please clearly quote the colour and the RAL code.

Roof outlets are manufactured in aluminium. Grates and clamping rings or flanges are polyester powder coated.

Returns Policy

Returns of polyester powder coated product will be for Heritage Black only, with prior agreement and at the discretion of Marley Alutec. Any agreed returns will incur a 50% re-stocking charge which covers the handling, checking and administration of the returned items.

We are unable to accept the return of any other Polyester Powder Coated or Soffit, Fascia & Coping product.

Cancellation Policy

Most Marley Alutec products are supplied on a "made to order" basis, therefore any non-stocked Polyester Powder Coated (PPC), Evoke fascia, soffit and copings, and bespoke items cannot be amended or cancelled once production has commenced (normally within 24 hours of receipt of order).

Marley Alutec will issue an order acknowledgement confirming our interpretation of your order therefore please ensure this is checked. Any alterations to this order should be notified immediately. Bespoke items will require a drawing approval prior to manufacture commencement.

Delivery Charges

Product group	Based on list value per delivery	Delivery Charge
Pipe, Gutter, Fascia, Soffit and Coping	Up to £500 net	£75
	£501 - £1,000 net	£50
	Above £1,000	No Charge
Fittings & Outlets	Up to £500 net	£30
	£501 - £1,000 net	£20
	Above £1,000	No Charge

For deliveries outside of UK mainland please contact customer services.

Lead Times*

2 day delivery lead times

Heritage black & Mill finish		Anthracite Grey (RAL 7016) & Mill finish	
Gutter systems	Downpipe systems	Gutter systems	Downpipe systems
<ul style="list-style-type: none"> Evolve Half Round GT5 range Evolve Deepflow GE5 range Evolve Box GB5 range Evolve Ogee GY5 range Aligator Classic GK4 range Traditional Half Round (4", 4.5" & 5") GC4, GC1 & GC5 ranges Traditional Moulded (5" & 6") GM5 & GM6 ranges 	<ul style="list-style-type: none"> Evolve 63mm Pipe RT2 range Tudor (63mm & 76mm) TR2 & TR3 ranges Flushfit 76mm RE3 range Flushfit 72x72mm RJ3 range 	<ul style="list-style-type: none"> Evolve Half Round XGT5 range Evolve Deepflow XGE5 range Evolve Box XGB5 range 	<ul style="list-style-type: none"> Evolve 63mm Pipe XRT2 range Flushfit 76mm dia XRE3 range Flushfit 72x72mm XRJ3 range

All other standard colour products will be delivered within 10 working days of order except Giant which is 15 working days, for specific enquiries contact projects@marleyalutec.co.uk.

All other products in Mill finish will be delivered within 5 working days of order. See page 6 for details of our standard colours.

*Subject to availability on items for 2 day delivery.

Other lead times:

Soffit & Fascia 10 working days
 Coping 20 working days
 Roof outlets 2 working days



Contacts

Estimate requests and price enquiries: email: **projects@marleyalutec.co.uk** Tel: **01234 359438**.

Order placement: **orders@marleyalutec.co.uk** Tel: **01234 359438** Fax: **01234 357199**

(Orders only accepted by email, post or fax)

Order progression: Tel: **01234 359438**.

Please state colour when ordering.



Orders received by 3.30pm on normal business days will be processed on the day of receipt.

Orders received after 3.30pm will be processed the next business day.

Please note that the lead time/due date for the order, will be calculated from the date of processing.

Technical enquiries: **technical@marleyalutec.co.uk** Tel: **01234 344108**.

Free estimating tool available at **www.marleyalutec.co.uk/calculators**



Head office

For general enquiries, please call **01234 359438**

For technical enquiries please call **01234 344108**

email: projects@marleyalutec.co.uk

Fax: **01234 357199**

Unit 1 (G-H), Viking Industrial Park, Hudson Road,
Elms Farm Industrial Estate, Bedford MK41 0LZ



 /marleyalutec

 @marleyalutec

 /company/marley-alutec

www.marleyalutec.co.uk