

High-Performance Waterproofing Systems



A Guide to Design and Specification
for Roofing & Car Park Applications



About this brochure

In this brochure you will find detailed information on our comprehensive range of roofing and waterproofing solutions and services designed to satisfy virtually every conceivable application.

As budget and regulatory pressure builds on professionals within the construction industry, so too does the requirement to work with a manufacturer who offers a comprehensive range of added value services and a 'cradle to grave' approach to providing the right solution.

With the industry's most innovative waterproofing solutions comes unrivalled design and technical support, and a commitment to develop strong links between specifier, installer and the building owner.

130 Years of Knowledge

IKO continues to remain committed to its family values of entrepreneurial spirit, craftsmanship and innovation in roofing, waterproofing and insulation that were the foundation of the business in 1951, as envisioned by IKO founder, Israel Koschitzky.

IKO is a truly Global enterprise, distributing products to 96 countries around the globe with manufacturing plants in Canada, United States, United Kingdom, Belgium, Holland, France and Slovakia.

5 Flat Roofing

The IKO Service	9
Bituminous Reinforced Systems	14
Cold Applied Liquid Waterproofing Systems	28
Complementary Membranes	34
Design Considerations	38
Typical Details	

51 Balconies & Walkways

Cold Applied Liquid Waterproofing	53
-----------------------------------	----

57 Pitched Roofing

Composite Tile System	59
Light Steel Sheeting System	63
Underslating Membranes	68
Complementary Products	72

75 Industrial Sheeting & Cladding

Cold Applied Liquid for Pitched Metal Roofing	77
Cold Applied Liquid for Systems for Sheeting & Cladding	81

83 Car Park

Cold Applied Liquid for Car Parks	85
-----------------------------------	----

89 Insulation

Insulation for Flat Roofs & Inverted Roofs, Balconies & Walkways	91
--	----

99 Accessories & Annex

126 Project Case Studies

Bituminous Reinforced Systems	128
Cold Applied Liquid Waterproofing	133
Pitched Roofing	137

British made for British trade

IKO PLC have been manufacturing British made products for over 130 years and continue to invest in UK manufacturing; developing and producing new products to service market demand directly from the various manufacturing plants here in the UK. Manufacturing in the UK comes with a number of excellent benefits, for example, quality control, speed of response and answer to market requirements and decreased CO₂ emissions from transportation.



flat roofing

The IKO Service	9
Bituminous Reinforced Systems	14
Cold Applied Liquid Waterproofing Systems	28
Complementary Membranes	34
Design Considerations	38
Typical Details	46



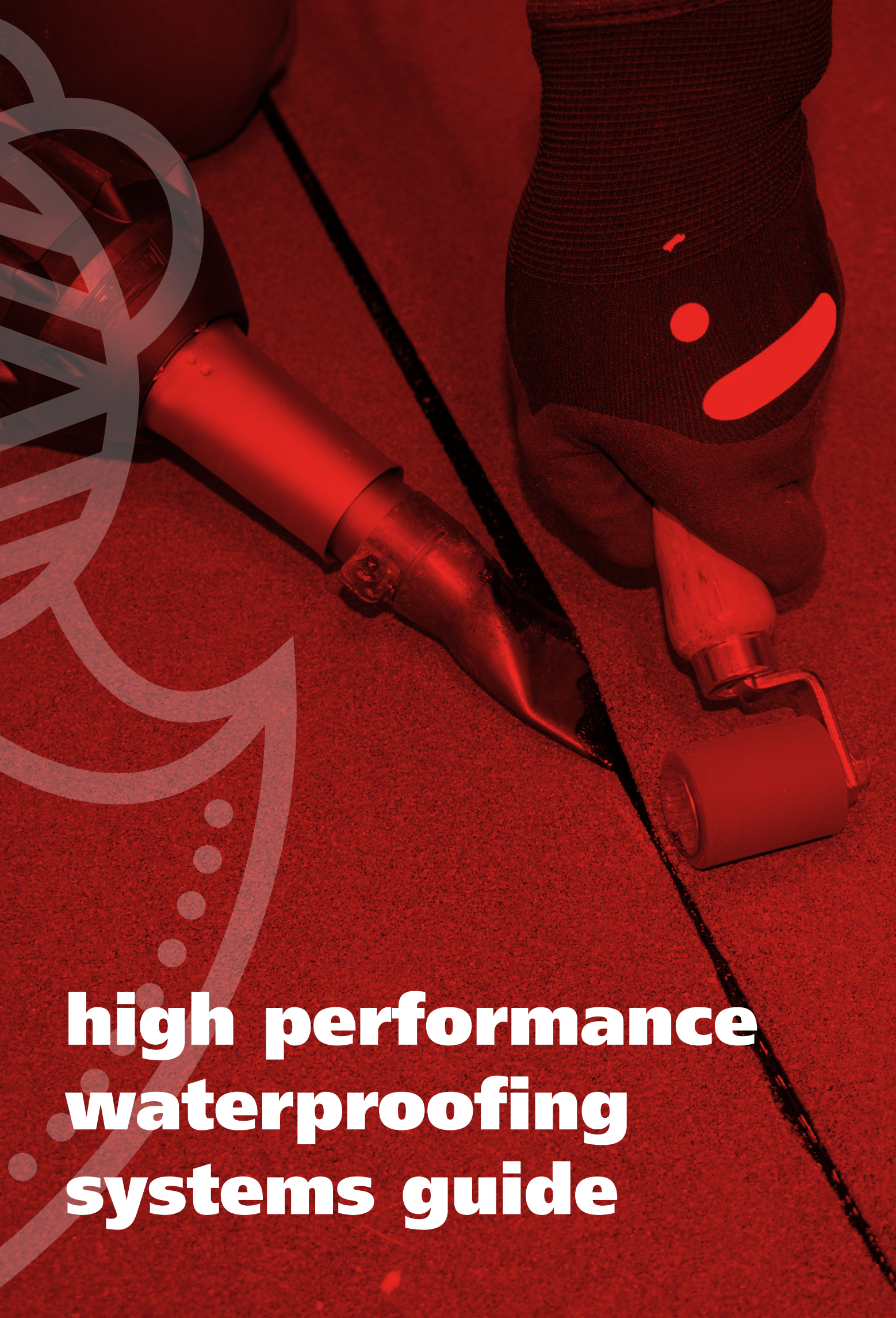

**high performance
waterproofing
systems guide**

‘ A clear, well understood and accurate design brief is the catalyst for success ;

The best roofing solutions are achieved when the supply chain works towards a common goal. Working side by side with our clients allows you to share both problems and priorities – planning a pathway to the roofing solution that’s right for the project.

By understanding the requirements from your perspective, IKO are able to deliver bespoke packages that suit the exact parameters of your project. This leads to better quality, better performing roofing and waterproofing systems on budget, on time, every time. As your roofing partner, IKO will guide you step by step through the key stages that create a successful project.

RIBA Approved CPD from IKO. Extend your knowledge of bituminous and cold applied roofing systems

As part of the commitment to Continuing Professional Development (CPD), IKO PLC provides a well-balanced, comprehensive seminars on the variations in flat roof systems available to specifiers, architects, building owners and contractors alike in the form of our RIBA Approved CPD’s.





1. CONSULTATION

We start by listening to you, your requirements and your brief for the project.

2. SURVEY

Carried out by our IKO skilled and experienced surveyors.

3. DESIGN

IKO provide a full set of bespoke specifications for the job.

4. SOLUTION

IKO range encompasses both traditional roofing systems and innovative solutions.

5. INSTALLATION

Only ever installed by fully qualified and registered IKO contractors.

6. INSPECTION

An IKO roofing solution is an investment that can deliver up to 50 years of faultless service.

7. GUARANTEE

A long-term commitment from you deserves an equally long-term commitment from us.

Consultation



We start by listening to you, your requirements and your brief for the project, discussing the finer details with you so that every aspect of your new or replacement roofing system has been specified.

Amongst other things, we will look at:

Your building use: Is it a residential project, a public building or a works unit?

Performance: Are you expecting your roof to keep in noise as well as keep out water? Are there thermal insulation requirements above and beyond those set in the regulations?

Budgets: What are you expecting to achieve within your given budget?

Guarantee requirements: We offer a range of service contracts and guarantees.

Planned maintenance: We can plan for regular inspections and maintenance to prolong the life of your roof in the short and long-term.



Survey

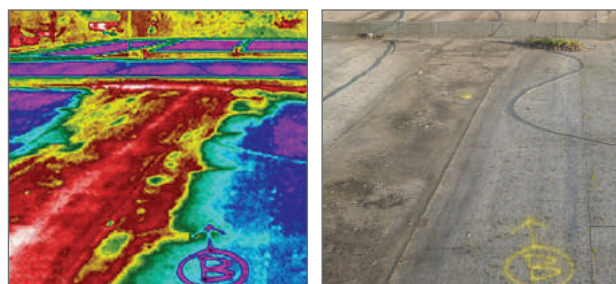

For refurbishment projects, an exhaustive assessment of the roof surface and sub layers, carried out by our skilled and experienced surveyors will give you a thorough analysis concerning the condition of your roof.

This will involve:

- Visual and physical inspections, including core sampling and moisture probe analysis
- Detailed defects analysis and recommendations for repair or replacement
- A complete catalogue of deck type, insulation, waterproofing, drainage, detailing and accessories
- Photographic records

The above investigation work will usually ensure we have the information we need to give you the best advice. However, in more challenging circumstances, we can employ the latest Roof scan Infra-red imaging technology to confirm our findings or reveal a more detailed and complete picture of the existing roof build-up.

This allows us to measure accurately the extent of any water ingress and make a more informed judgement on which areas must be stripped and which can be overlaid; providing more accurate information for planning and budgeting.

Design



The compilation of a full set of bespoke specifications for the job can now be produced, taking into account our discussions and surveys.

Technical calculations

Assessing thermal performance and condensation risk within the roof build-up, the potential effect of wind uplift on the roof and the weight load of the specified system, so structural advice can be sought where necessary.

Building Regulations compliance

Recommendations can include all current and anticipated requirements for drainage, thermal, fire and acoustic performance.

Tapered insulation schemes

A design for insulation tapered to create the falls required for drainage and to comply with the overall thermal performance required.

Accessories and access planning

Full specification for roof lights, outlets, handrail systems and trim positioning as well as plans for maintenance walkways or escape routes.

CAD site plans

General layouts for the roof can be provided, supported by detail drawings of perimeter abutments and roof penetration points.

Building Information Modelling (BIM)

Use the latest digital BIM technology to create an intelligent 3D model that can be referred to throughout the project life cycle to make informed decisions. IKO have created BIM content in Revit (.rvt) format for a range of IKO roofing and waterproofing systems.

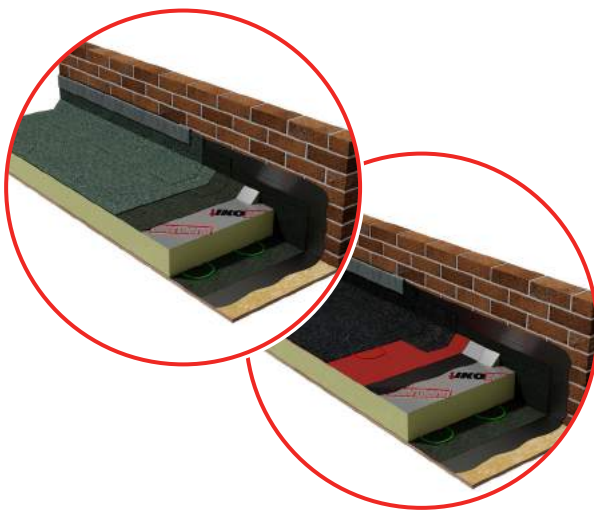

IKO customer project portal

Recognising that, for our clients, the larger the project portfolio, the more important it is to be able to manage it efficiently, swiftly and securely. You want quick and easy access to a wealth of information, and you need the peace of mind of knowing that everything is within arms' reach. With this in mind.

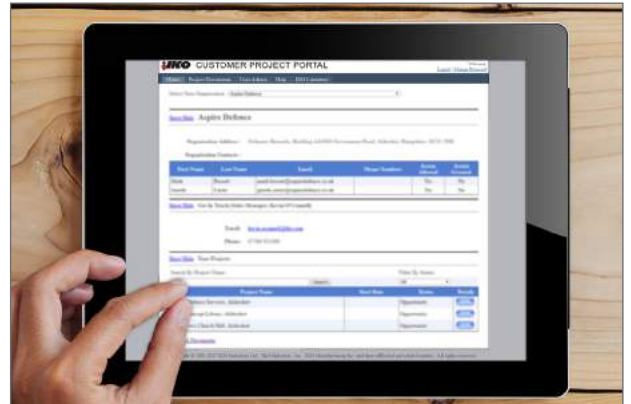

A bespoke client extranet is your gateway to the IKO Customer Project Portal. This comprehensive online system is accessed via a unique secure web link, and will contain a host of essential information on your roofing projects from beginning to end.

From initial site survey and specification to project completion and annual inspections – all the details, history, reports and certification relevant to your project are securely stored online and can be retrieved at the click of a button.

You'll also find contact details for your IKO Business Manager and company profiles of IKO Approved Installers, plus links to our comprehensive library of case-studies, technical data sheets and brochures. In short, everything you need to manage your projects.



These are available to download from our website
www.ikogroup.co.uk/bim

Solution



An extensive choice of roof waterproofing systems is one of the reasons we are preferred partners for so many specifiers, contractors, building managers and local authorities across the UK and beyond.

This is the result of significant investment in R&D on a global scale, the IKO range encompasses both traditional roofing systems and innovative solutions. It is this breadth and diversity which enables us to match the perfect product to every project, whether it is new build or refurbishment.

A full range of system accessories and roof asset management services ensures the IKO technology selected will continue to reward your investment for many years to come.

Reinforced Bitumen Membranes

- Torch-On Systems
- Torch-Free Systems
- Hybrid Systems

Liquid Waterproofing Membranes

- Polyurethane System
- Methacrylate System

Green Roofs

- Extensive System
- Intensive System
- Biodiverse System



Installation



IKO's high-performance roofing systems are only ever installed by fully qualified and registered IKO contractors.

With comprehensive selection and training criteria and nationwide network coverage, you can be confident that whatever location your project is situated in, your installation will be managed to the highest possible standards.



Under the terms of our installation contract, you'll enjoy agreed service levels for:

- Pre-contract meetings
- Dedicated project monitoring
- Qualified on-site supervision
- Reporting procedures and client liaison
- Management of variations
- Review meetings
- Regular site inspections
- Making good and site clearance
- Sign-off inspections
- Prompt and professional response to technical issues on site

Inspection



An IKO roofing solution is an investment that can deliver up to 50 years of faultless service. That kind of long-term commitment from you deserves an equally long-term commitment from us.

A framework of inspection and maintenance visits is available through our network of Approved Installers. A programme of periodic visits can be established throughout the time-frame of the IKO Roofing Systems guarantee.

As part of our service, you'll benefit from:

- Regular written reports with photographic record
- A centralised database containing all the technical details of your roof from consultation to completion
- The option of a managed project file
- A client specific portal through which you can access all the information on your project at any time



Guarantee

A long-term commitment from you deserves an equally long-term commitment from us, and that's why all of our waterproofing systems are fully backed-up by long-term, meaningful guarantees offering ultimate peace of mind.



**bituminous
reinforced
System**

Reinforced Bituminous System Selector



The flat roof is an integral part of building architecture. Today's flat roofing systems must consider fire, thermal and environmental performance alongside waterproofing - but whatever you need your flat roof to do, IKO have the products to do it.

System Selector Bituminous Reinforced Membranes

IKO Systems	System Waterproofing Layers	Guarantee Years	BBA Agrément Certificate	Broof(t4)	Method of Application*			Cap Sheet Mineral Colours	Page
					Torch-On	Hybrid	Torch-Free		
IKO UPXL	2	Up to 30	15/5238	●		●	●	Black, Red	16
IKO Ultra Prevent	2	Up to 25	91/2671	●	●	●		Black, Brown, Green	18
IKO Mach One	1	Up to 20	00/3760	●			●	Black, Brown, Green	20
IKO Safestick	2	Up to 20	18/5580	-			●	Black, Brown, Green	22
IKO Carrara	2	Up to 20	-	-	●	●		White	24
IKO Goldseal	2	Up to 20	91/2671	●	●	●		Black, Brown, Green	26

Notes: Additional system options and guarantee level are available. Contact your local IKO Business Manager for further information.

*Method of Application

Torch-On Systems	IKO's Torch-On Membranes offer simple, rapid application and are installed by Approved Contractors. As the bonding bitumen forms part of the core membrane itself, torch-on systems provide additional certainty of completely homogeneous modified bitumen throughout.
Hybrid Systems	IKO's Hybrid Systems offer the ultimate combination of proven products, speed of application and safe installation practices on site. The system effectively combines the use of a quality self-adhesive underlay, high-performance PIR insulation, and the proven performance of an IKO Torch-On Cap Sheet.
Torch-Free Systems	IKO's range of torch-free systems include; a choice of built-up adhered systems, a robust single layer system that can be bonded, mechanically-fixed or ballasted and a self-adhesive built up roofing system option.

What is Safe2Torch?



The National Federation of Roofing Contractors (NFRC) issued new guidelines for safe practice when using gas torches in roofing, in July 2017. The Safe2Torch campaign has been developed in partnership with contractor and manufacturer members of the NFRC.

The main aim of Safe2Torch is to promote the safe use of hot works from specification to completion, providing a joined-up approach to every situation where there is any risk of fire.

All IKO specification sales and design teams have signed up to the Safe2Torch guidance document.

In practice this means IKO is committed to providing specifications to its clients with Safe2Torch applications identified in every bespoke design.

IKO's bespoke service is well equipped to provide Safe2Torch specifications. Each IKO built-up roofing specification can provide membranes and methods of application to design out and minimise risks associated with hot works.





IKO UPXL is a superior no compromising solution that offers extra quality and extra guarantees, designed to offer the best waterproofing performance.

This premium roofing system uses only the very best components, materials and technology to offer extra durability, extra reliability and extra peace of mind. IKO UPXL membranes have been engineered to incorporate thicker coatings with enhanced polymer content and high strength reinforcements for outstanding durability, high flexibility and workability. IKO UPXL provides more than just the very best waterproofing membranes. It's a complete system package delivering the very best technical performance and the highest levels of accreditation. IKO UPXL incorporates the Prevent Graphite Fire Wall Technology with self-extinguishing properties and has been classified as Broof(t4) in accordance with BS EN 13501-5: 2005 fire classification of construction products and building elements.



System Benefits

- BBA Agrément Certificate 15/5238 - durability with service life in excess of 35 years
- Prevent Graphite Fire Wall Technology
- Broof(t4) in accordance with BS EN 13501-5: 2005 fire classification of construction products and building elements
- Exceptional mechanical strength and dimensional stability
- Optimum SBS polymer content for flexibility and workability
- Superior granular finish, with higher colour stability, improved adhesion and better coverage
- Reassurance of a 30-year guarantee and industry-leading technical support as part of a green roof design, the built-in anti-root technology makes IKO UPXL a 'one membrane fits all' System
- Choice of installation methods including a completely flame-free adhered installation option

IKO UPXL: Hybrid System

IKO UPXL Hybrid System offer the ultimate combination of proven products, speed of application and safe installation practices on site. The system effectively combines the use of a quality self-adhesive underlay, high-performance PIR insulation, and on IKO Torch-On Cap Sheet. IKO UPXL Hybrid Systems are installed by IKO Approved Contractors (see page 13).

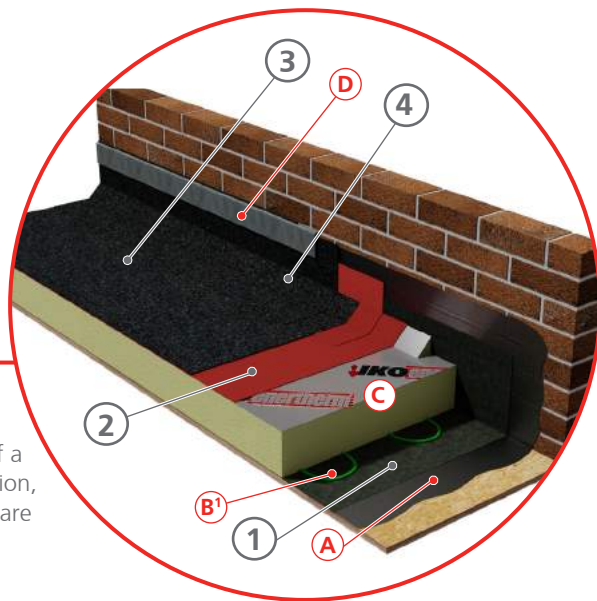

	Membrane	Description	Weight	Size	Base Carrier	Surface Finish
①	Vapour Control Layer	IKO Systems Self-Adhesive VCL	36kg	15x1m	Polyester	Fine Minerals
②	Underlay	IKO UPXL Self-Adhesive Underlay	40kg	16x1m	Polyester	Fine Minerals
③	Cap Sheet	IKO UPXL Torch-On Cap Sheet	43kg	8x1m	Polyester	Black, Red Minerals
④	Detailing Cap Sheet	IKO UPXL Torch-On Detailing Cap Sheet	39kg	8x1m	Polyester	Black, Red Minerals

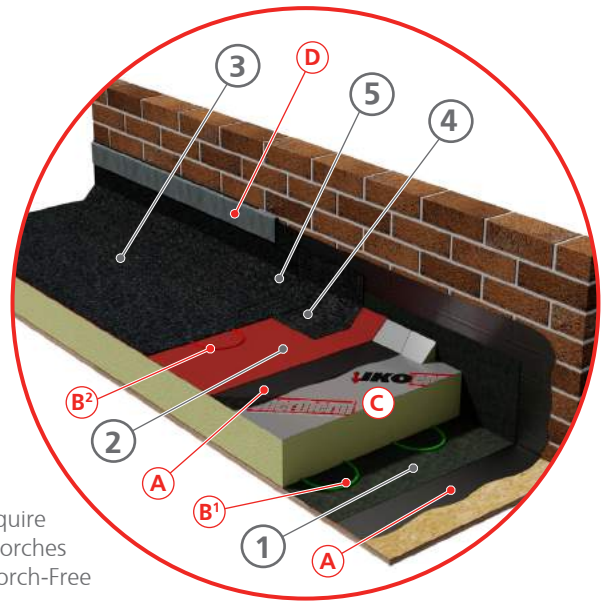

IKO UPXL: T-F (Torch-Free) System

The IKO UPXL Torch-Free System offers a completely flame-free specification option, as a solution for projects where the criteria require cold applied installation. The need for hot poured bitumen or gas torches is eliminated, allowing fast, clean and safe installation. IKO UPXL Torch-Free Systems are installed by IKO Approved Contractors (see page 13).

	Membrane	Description	Weight	Size	Base Carrier	Surface Finish
①	Vapour Control Layer	IKO Systems Self-Adhesive VCL	36kg	15x1m	Polyester	Fine Minerals
②	Underlay	IKO UPXL Self-Adhesive Underlay	40kg	16x1m	Polyester	Fine Minerals
③	Cap Sheet	IKO UPXL Torch-Free Cap Sheet	46kg	8x1m	Polyester	Black, Red Minerals
④	Detailing Underlay	IKO Systems Self-Adhesive Detailing Underlay	40kg	16x1m	Polyester	Film
⑤	Detailing Cap Sheet	IKO UPXL Self-Adhesive Detailing Cap Sheet	35kg	8x1m	Polyester	Black, Red Minerals

Complementary Products

Ⓐ	Primer	IKOpro Systems Bonding Agent	Page 101
Ⓑ	Adhesive	B ¹ - IKOpro Sprayfast IBA; PU adhesive for insulation board	Page 102
		B ² - IKOpro Sprayfast BMA; PU adhesive for bituminous roofing membrane	Page 102
Ⓒ	Insulation	IKO enertherm ALU; high-performance PIR insulation board	Page 92
Ⓓ	Flashing	IKOfash Lead-Free Flashing	Page 115

Additional Information



Cap Sheet Colours	
	
Black	Red (made to order)

Certificates & Accreditations	
Fire Performance	Broof(t4) in accordance with BS EN 13501-5: 2005 fire classification of construction products and building elements
BBA	Agrément Certificate 15/5238
NHBC	Accepted
CE Marking	In accordance with harmonised European Standards BS EN 13707: 2013
Site Certification	ISO 9001 / ISO 14001 / BES 6001



The IKO Ultra Prevent System incorporates the Prevent Graphite Fire Wall Technology with self-extinguishing properties and has been classified as Broof(t4) in accordance with BS EN 13501-5: 2005 fire classification of construction products and building elements, without affecting the exceptional waterproofing function or life expectancy of the membranes.

IKO Ultra Prevent offers the latest generation of high-performance, elastomeric reinforced bitumen roofing membranes with significant advantages over conventional polyester-based roofing membranes. IKO Ultra Prevent Membranes have enhanced polyester/glass fibre, dual-laminate base fabrics for added strength and dimensional stability. IKO Ultra Prevent incorporates the Prevent Graphite Fire Wall Technology with self-extinguishing properties and has been classified as Broof(t4) in accordance with BS EN 13501-5: 2005 fire classification of construction products and building elements. A high content SBS polymer modified bitumen coating also gives outstanding low-temperature flexibility (-25°C).

System Benefits



- BBA Agrément Certificate 91/2671 - durability with service life in excess of 30 years
- Prevent Graphite Fire Wall Technology
- Broof(t4) in accordance with BS EN 13501-5: 2005 fire classification of construction products and building elements
- Highly stable polyester/glass fibre laminate base fabrics
- High content SBS polymer modification to coating bitumen
- Low temperature flexibility - minus 25°C

IKO Ultra Prevent: Hybrid System

IKO Ultra Prevent Hybrid Systems offer the ultimate combination of proven products, speed of application and safe installation practices on site. The system effectively combines the use of a quality self-adhesive underlay, high-performance PIR insulation an IKO Torch-On Cap Sheet, installed by IKO Approved Contractors (see page 13).

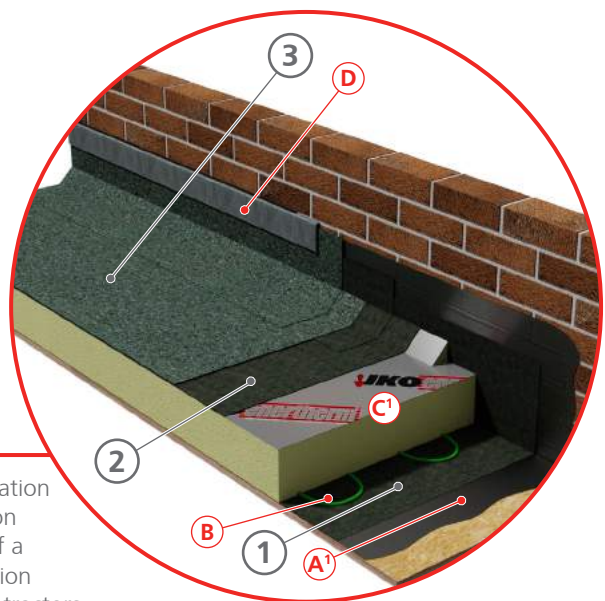

	Membrane	Description	Weight	Size	Base Carrier	Surface Finish
①	Vapour Control Layer	IKO Systems Self-Adhesive VCL	36kg	15x1m	Polyester	Fine Minerals
②	Underlay	IKO Systems Self-Adhesive Underlay	36kg	16x1m	Polyester	Fine Minerals
③	Cap Sheet	IKO Ultra Prevent Torch-On Cap Sheet	40kg	8x1m	Polyester/Glass	Black, Brown, Green Minerals

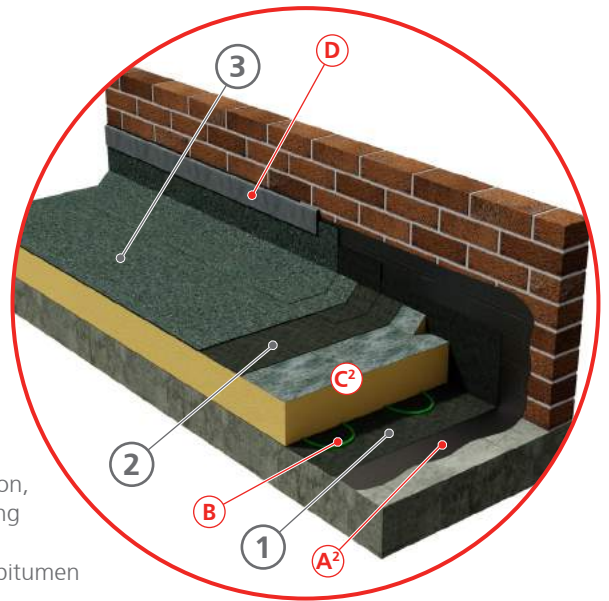

IKO Ultra Prevent: Torch-On System

IKO Ultra Prevent Torch-On Membrane offer simple, rapid application, installed by IKO Approved Contractors (see page 13). As the bonding bitumen forms part of the core membrane itself, torch-on systems provide additional certainty of completely homogeneous modified bitumen throughout.

	Membrane	Description	Weight	Size	Base Carrier	Surface Finish
①	Vapour Control Layer	IKO Systems Torch-On VCL	36kg	12x1m	Polyester	Sand
②	Underlay	IKO Systems Torch-On Underlay	38kg	12x1m	Polyester	Sand
③	Cap Sheet	IKO Ultra Prevent Torch-On Cap Sheet	40kg	8x1m	Polyester/Glass	Black, Brown, Green Minerals

Complementary Products			
Ⓐ	Primer	A ¹ - IKOpro Systems Bonding Agent	Page 101
		A ² - IKOpro Quick Dry Bitumen Primer	Page 101
Ⓑ	Adhesive	IKOpro Sprayfast IBA; PU adhesive for insulation board	Page 102
Ⓒ	Insulation	C ¹ - IKO enertherm ALU; high-performance PIR insulation board	Page 92
		C ² - IKO enertherm BGF; high-performance PIR insulation board	Page 93
Ⓓ	Flashing	IKOfash Lead-Free Flashing	Page 115

Additional Information



Cap Sheet Colour Options		
		
Black	Brown	Green

Certificates & Accreditations	
Fire Performance	Broof(t4) in accordance with BS EN 13501-5: 2005 fire classification of construction products and building elements
BBA	Agrément Certificate 91/2671
NHBC	Accepted
CE Marking	In accordance with harmonised European Standards BS EN 13707: 2013
Site Certification	ISO 9001 / ISO 14001 / BES 6001



IKO Mach One is a cleaner, sustainable and fast track system for projects needing a flame-free installation.

IKO Mach One is a robust single-layer system combining advanced technology with the quality finish of a traditional felt roof. The membrane uses a polyester/glass fibre composite reinforcement with exceptional mechanical strength and dimensional stability which is saturated and coated with a high-percentage SBS modified bitumen. IKO Mach One incorporates the Prevent Graphite Fire Wall Technology with self-extinguishing properties and has been classified as Broof(t4) in accordance with BS EN 13501-5: 2005 fire classification of construction products and building elements.

System Benefits



- BBA Agrément Certificate 00/3760 - durability of at least 30 years
- Quality in Construction (R&D) Award
- Flame-free system
- Prevent Graphite Fire Wall Technology
- Broof(t4) in accordance with BS EN 13501-5: 2005 fire classification of construction products and building elements
- PU adhered or mechanically fixed options
- Single layer, highly robust membrane
- Superior puncture resistance
- Rapid, clean and safe installation
- SBS elastomeric bitumen coating - low temperature flexibility (-20°C)
- Rapid sealing of laps

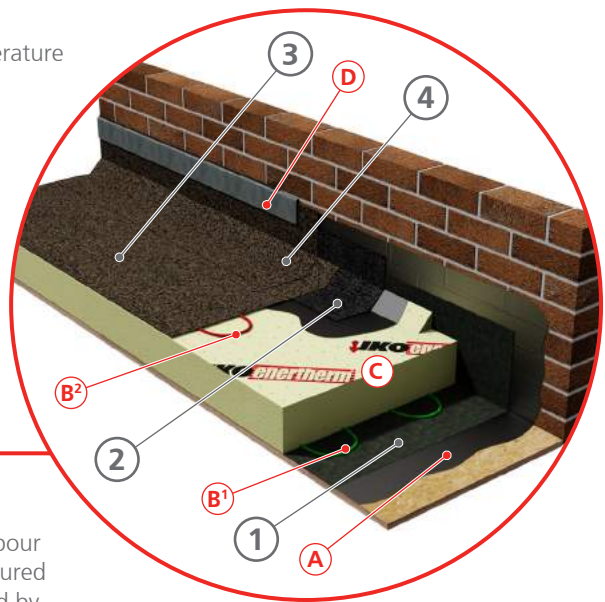

IKO Mach One System

IKO Mach One Flame-Free System can be bonded with polyurethane adhesive, mechanically fixed or ballasted. Combined with a self-adhesive detailing membrane and vapour control layer, IKO Mach One eliminates the need for hot poured bitumen or gas torches. IKO Mach One Systems are installed by IKO Approved Contractors (see page 13).

	Membrane	Description	Weight	Size	Base Carrier	Surface Finish
①	Vapour Control Layer	IKO Systems Self-Adhesive VCL	36kg	15x1m	Polyester	Fine Minerals
②	Detailing Underlay	IKO Systems Self-Adhesive Detailing Underlay	40kg	16x1m	Polyester	Film
③	Cap Sheet	IKO Mach One Membrane	40kg	7.5x1m	Polyester/Glass	Black, Brown, Green Minerals
④	Detailing Cap Sheet	IKO Safestick Prevent Cap Sheet	31kg	8x1m	Polyester	Black, Brown, Green Minerals



‘ IKO Mach One fits the bill for a lot of clients. We find it ideal for projects where safety issues are of paramount importance ’

Complementary Products			
(A)	Primer	IKOpro Systems Bonding Agent	Page 101
(B)	Adhesive	B ¹ - IKOpro Sprayfast IBA; PU adhesive for insulation board	Page 102
		B ² - IKOpro Sprayfast BMA; PU adhesive for bituminous roofing membrane	Page 102
(C)	Insulation	IKO enertherm MG; high-performance PIR insulation board	Page 95
(D)	Flashing	IKOfash Lead-Free Flashing	Page 115

Additional Information



Cap Sheet Colour Options		
		
Black	Brown	Green

Certificates & Accreditations	
Fire Performance	Broof(t4) in accordance with BS EN 13501-5: 2005 fire classification of construction products and building elements
BBA	Agrément Certificate 00/3760
NHBC	Accepted
CE Marking	In accordance with harmonised European Standards BS EN 13707: 2013
Site Certification	ISO 9001 / ISO 14001 / BES 6001

IKO safestick prevent Graphite Based Self-Adhesive System



IKO Safestick Prevent is a revolutionary self-adhesive system combining graphite fire retardant technology with the latest tackifier chemistry for outstanding all-round performance.

Where traditional hot-application techniques are inappropriate or prohibited, this combination of high-tensile polyester and SBS elastomeric bitumen coating offers all the benefits of a high-performance multilayer built-up system with a fire-safe application. IKO Safestick Prevent also features graphite fire retardant technology within the cap sheets to comply with the highest UK and European fire performance standards.



System Benefits

- BBA Agrément Certificate 18/5580 - durability of at least 30 years
- Fire safe in application - no naked flames used during installation
- IKO Prevent fire retardant technology
- Meets highest UK and European fire performance standards
- Easy installation - no gas torches or hot bitumen required (self-adhesive/heat welding only)
- High strength - tough polyester-based membranes
- SBS elastomeric bitumen coating - low temperature flexibility (-20°C)
- Application in temperatures as low as 5°C
- Ideal for use as complete roof waterproofing system, or as a fire safe detailing option
- Comprehensive guarantees available covering materials, workmanship and design

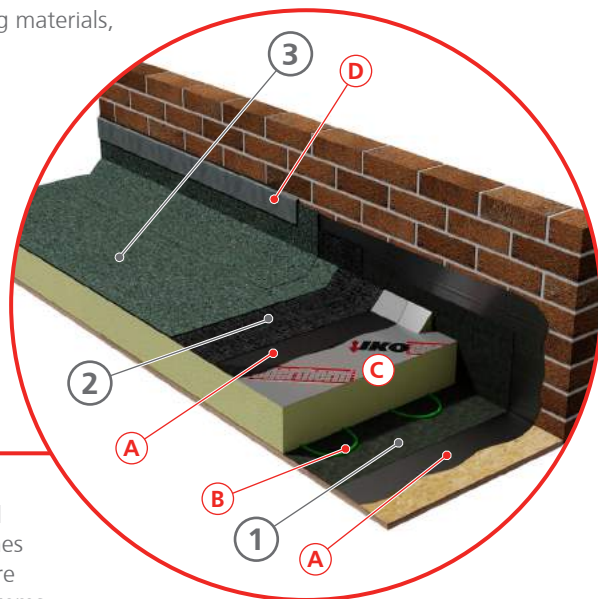

IKO Safestick Prevent System

IKO Safestick Prevent is a two layer self-adhesive system using the latest tackifier chemistry for outstanding all-round performance. As well as full roof installations, the membranes can be used as detailing for fire risk details on projects where hot-applied systems are specified. IKO Safestick Prevent Systems are installed by IKO Approved Contractors (see page 13).

	Membrane	Description	Weight	Size	Base Carrier	Surface Finish
①	Vapour Control Layer	IKO Systems Self-Adhesive VCL	36kg	15x1m	Polyester	Fine Minerals
②	Underlay	IKO Systems Self-Adhesive Detailing Underlay	40kg	16x1m	Polyester	Film
③	Cap Sheet	IKO Safestick Prevent Cap Sheet	31kg	8x1m	Polyester	Black, Brown, Green Minerals



Complementary Products			
(A)	Primer	IKOpro Systems Bonding Agent	Page 101
(B)	Adhesive	IKOpro Sprayfast IBA; PU adhesive for insulation board	Page 102
(C)	Insulation	IKO enertherm ALU; high-performance PIR insulation board	Page 92
(D)	Flashing	IKOfash Lead-Free Flashing	Page 115

Additional Information



Cap Sheet Colour Options		
		
Black	Brown	Green

Certificates & Accreditations	
Fire Performance	Broof(t4) in accordance with BS EN 13501-5: 2005 fire classification of construction products and building elements
NHBC	Accepted
CE Marking	In accordance with harmonised European Standards BS EN 13707: 2013
Site Certification	ISO 9001 / ISO 14001 / BES 6001



IKO Carrara is an innovative, ecological roofing membrane combining numerous technologies for improvement of the environmental impact.

To reduce extremely damaging, secondary particle matter in the air, IKO Carrara brings together many different innovations to create 'Air Care Technology'. IKO Carrara mineral finish is coated with a special type of titanium dioxide (TiO₂). UV rays cause the membrane to act as a catalyst to convert nitrogen oxides and sulphur oxides (NO_x and SO_x) - which contribute to the acidification of the environment and the greenhouse effect - into harmless and environmentally neutral substances. IKO Carrara incorporates the Prevent Graphite Fire Wall Technology with self-extinguishing properties and has been classified as Broof(t4) in accordance with BS EN 13501-5: 2005 fire classification of construction products and building elements.

System Benefits



- Purifies air by converting NO_x (nitrogen oxide) and SO_x (sulphur oxide) into harmless environmentally-neutral substances
- Cool roof technology reflects and radiates absorbed heat through infrared radiation, so less internal cooling is needed
- UV protection from the white mineral finish also lowers surface temperatures by over 30°C, reducing thermal shocks and extending service life by at least 5 years
- Improves the urban environment by reducing the 'Urban Heat Island Effect' - a blanket of hot air above cities
- Prevent Graphite Fire Wall Technology
- Broof(t4) in accordance with BS EN 13501-5: 2005 fire classification of construction products and building elements
- Made from recycled materials including regenerated bitumen from old roof coverings and obsolete stock. The high quality reinforcing carrier uses recycled polymers
- 100% green energy is used in the manufacture of IKO Carrara

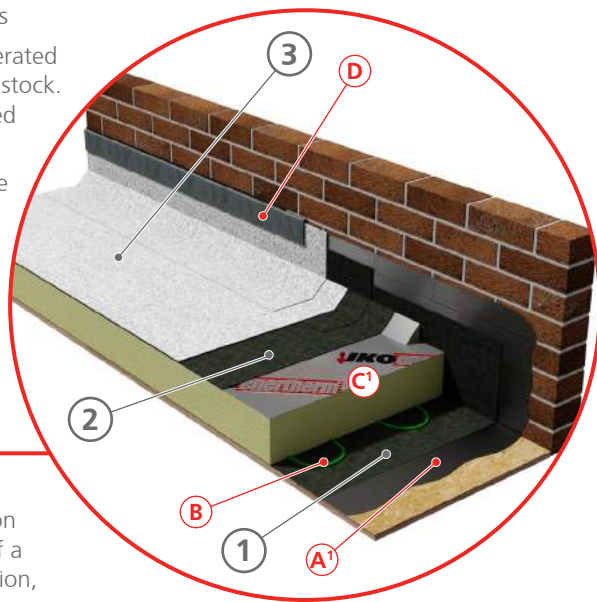

IKO Carrara: Hybrid System

IKO Carrara Hybrid System offer the ultimate combination of proven products, speed of application and safe installation practices on site. The system effectively combines the use of a quality self-adhesive underlay, high-performance PIR insulation, and an IKO Torch-On Cap Sheet, installed by IKO Approved Contractors (see page 13).

	Membrane	Description	Weight	Size	Base Carrier	Surface Finish
①	Vapour Control Layer	IKO Systems Self-Adhesive VCL	36kg	15x1m	Polyester	Fine Minerals
②	Underlay	IKO Systems Self-Adhesive Underlay	36kg	16x1m	Polyester	Fine Minerals
③	Cap Sheet	IKO Carrara Torch-On Cap Sheet	45kg	7.5x1m	Polyester/glass	White Minerals

IKO Carrara: Torch-On System

IKO Carrara Torch-On Membrane offer simple, rapid application and is installed by IKO Approved Contractors (see page 13). As the bonding bitumen forms part of the core membrane itself, torch-on systems provide additional certainty of completely homogeneous modified bitumen throughout.

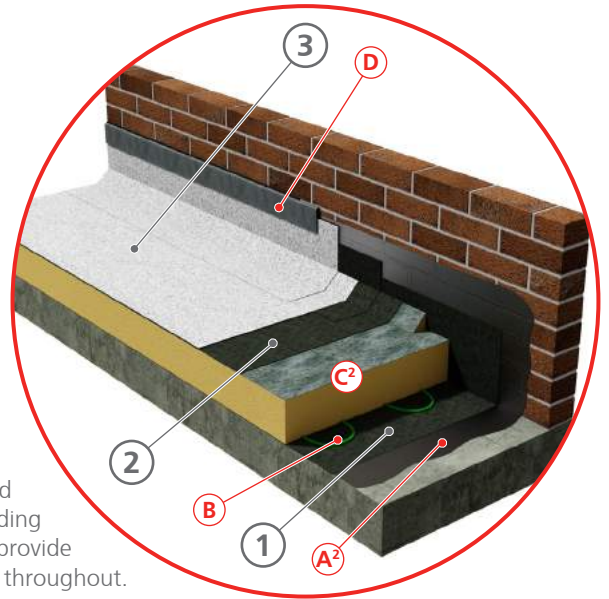

	Membrane	Description	Weight	Size	Base Carrier	Surface Finish
①	Vapour Control Layer	IKO Systems Torch-On VCL	36kg	12x1m	Polyester	Sand
②	Underlay	IKO Systems Torch-On Underlay	38kg	12x1m	Polyester	Sand
③	Cap Sheet	IKO Carrara Torch-On Cap Sheet	45kg	7.5x1m	Polyester/Glass	White Minerals

Complementary Products			
Ⓐ	Primer	A ¹ - IKOpro Systems Bonding Agent	Page 101
		A ² - IKOpro Quick Dry Bitumen Primer	Page 101
Ⓑ	Adhesive	IKOpro Sprayfast IBA; PU adhesive for insulation board	Page 102
Ⓒ	Insulation	C ¹ - IKO enertherm ALU; high-performance PIR insulation board	Page 92
		C ² - IKO enertherm BGF; high-performance PIR insulation board	Page 93
Ⓓ	Flashing	IKOfash Lead-Free Flashing	Page 115

Additional Information



Cap Sheet Colour Option

White

Certificates & Accreditations	
Fire Performance	Broof(t4) in accordance with BS EN 13501-5: 2005 fire classification of construction products and building elements
CE Marking	In accordance with harmonised European Standards BS EN 13707: 2013
Site Certification	ISO 9001 / ISO 14001



IKO Goldseal is a well-established and trusted brand. The IKO Goldseal System uses high-performance polyester reinforced membranes to offer a comprehensive and cost-effective solution.

IKO Goldseal's excellent service life comes from its exceptional mechanical strength and dimensional stability. IKO Goldseal incorporates the Prevent Graphite Fire Wall Technology with self-extinguishing properties and has been classified as Broof(t4) in accordance with BS EN 13501-5: 2005 fire classification of construction products and building elements.

System Benefits



- BBA Agrément Certificate No 91/2671, durability of at least 25 years
- Tough rot proof polyester reinforcement for membrane strength and durability
- Robust membrane with excellent tensile strength, elongation and tear resistance
- Prevent Graphite Fire Wall Technology
- Broof(t4) in accordance with BS EN 13501-5: 2005 fire classification of construction products and building elements
- Excellent puncture resistance against trafficking during work operations
- SBS elastomeric bitumen coating - low temperature flexibility (-20°C)

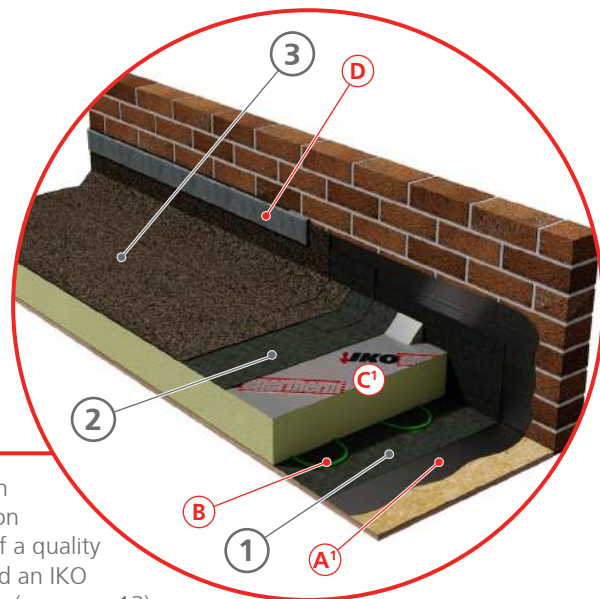

IKO Goldseal: Hybrid System

IKO Goldseal Hybrid System offers the ultimate combination of proven products, speed of application and safe installation practices on site. The system effectively combines the use of a quality self-adhesive underlay, high-performance PIR insulation, and an IKO Torch-On Cap Sheet, installed by IKO Approved Contractors (see page 13).

	Membrane	Description	Weight	Size	Base Carrier	Surface Finish
①	Vapour Control Layer	IKO Systems Self-Adhesive VCL	36kg	15x1m	Polyester	Fine Minerals
②	Underlay	IKO Systems Self-Adhesive Underlay	36kg	16x1m	Polyester	Fine Minerals
③	Cap Sheet	IKO Goldseal Torch-On Cap Sheet	38kg	8x1m	Polyester	Black, Brown, Green Minerals

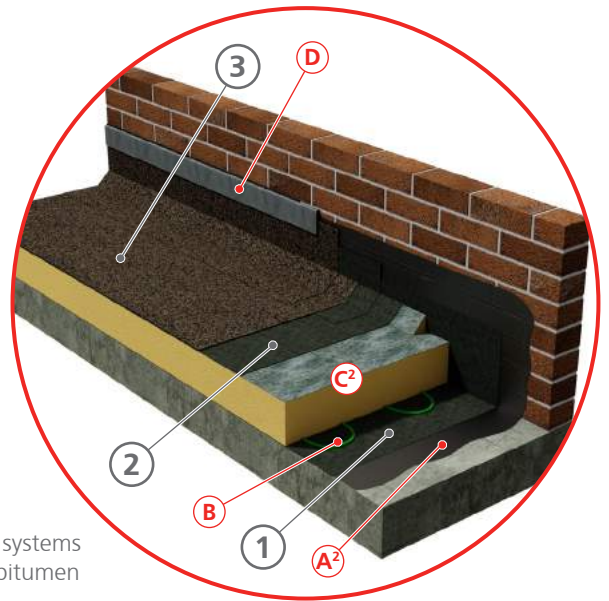

IKO Goldseal: Torch-On System

IKO Goldseal Torch-On membrane offer simple, rapid application and is installed by IKO Approved Contractors (see page 13). As the bonding bitumen forms part of the core membrane itself, torch-on systems provide additional certainty of completely homogeneous modified bitumen throughout.

	Membrane	Description	Weight	Size	Base Carrier	Surface Finish
①	Vapour Control Layer	IKO Systems Torch-On VCL	36kg	12x1m	Polyester	Sand
②	Underlay	IKO Systems Torch-On Underlay	38kg	12x1m	Polyester	Sand
③	Cap Sheet	IKO Goldseal Torch-On Cap Sheet	38kg	8x1m	Polyester	Black, Brown, Green Minerals

Complementary Products

Ⓐ	Primer	A ¹ - IKOpro Systems Bonding Agent	Page 101
		A ² - IKOpro Quick Dry Bitumen Primer	Page 101
Ⓑ	Adhesive	IKOpro Sprayfast IBA; PU adhesive for insulation board	Page 102
Ⓒ	Insulation	C ¹ - IKO enertherm ALU; high-performance PIR insulation board	Page 92
		C ² - IKO enertherm BGF ; high-performance PIR insulation board	Page 93
Ⓓ	Flashing	IKOfash Lead-Free Flashing	Page 115

Additional Information



Cap Sheet Colours Options		
		
Black	Brown	Green

Certificates & Accreditations	
Fire Performance	Broof(t4) in accordance with BS EN 13501-5: 2005 fire classification of construction products and building elements
BBA	Agrément Certificate 91/2671
NHBC	Accepted
CE Marking	In accordance with harmonised European Standards BS EN 13707: 2013
Site Certification	ISO 9001 / ISO 14001 / BES 6001



cold applied liquid waterproofing systems

System Selector



IKO Polimar is a high-performance range of liquid waterproofing systems. Regardless of application, IKO Polimar Systems are extremely versatile, completely cold applied and can be specified to match the longevity of your project through a range of build-up options.

System Selector - Liquid Cold Applied Waterproofing

IKO Systems	Waterproofing	Guarantee Years	Applications	Characteristics	Page
IKO Polimar FCS	PMMA (PolyMethyl Methacrylate)	Up to 25	<ul style="list-style-type: none"> • New build & refurbishment • Low odour option for sensitive sites • Green roofs 	<ul style="list-style-type: none"> • Fast curing; less than 1 hour between coats • BBA Agrément Certificate 14/5178 • Two components • Seamless, fleece reinforced system • Range of primers and preparation products • Rot and root resistant • FLL approved 	30
IKO Polimar EC/UV	PU (Polyurethane)	Up to 20	<ul style="list-style-type: none"> • New build & refurbishment • Suitable for flat and profiled pitched metal roofs 	<ul style="list-style-type: none"> • Moisture cured polyurethane technology • Good fire performance • Highly UV resistant topcoat • Long-lasting reinforced systems • Single liquid component 	32

Notes: Additional system options and guarantee levels are available. Contact your local IKO Business Manager for further information.





IKO Polimar (Fast Curing System) FCS Roof Waterproofing is a highly durable system for both refurbishment and new build projects, which offers the additional benefit of rapid curing.

IKO Polimar FCS Waterproofing System is specifically designed as a highly durable system for flat roofs. Since it is applied as a liquid, IKO Polimar FCS creates a seamless waterproofing system in which even the most complex roof penetrations can be reliably and durably incorporated. It is also extremely weather-resistant, crack bridging and highly flexible at low temperatures.

System Benefits



- BBA Agrément Certificate No 14/5178
- Fast curing; less than 1 hour between coats
- Seamless waterproofing with fleece reinforcement
- Liquid application ensures seamless incorporation and secure waterproofing of the most complex upstands
- Highly flexible and crack-bridging even at low temperatures
- Permanently weather-resistant (resistant to high and low temperatures, UV rays, hydrolysis)
- Resistant to most commonly used acids and alkali solutions
- Fully bonded to the substrate, therefore no flow paths for water
- Can be applied to almost any substrate
- Easy and fast application
- Rot and root resistant
- Low odour waterproofing option available

IKO Polimar FCS Roofing System

IKO Polimar FCS Roof System is a two-component, solvent-free system formulated for roller application.

IKO Polimar FCS Roofing System consists of proprietary primers (when required), a waterproofing layer, a reinforcement fleece and a sealant coat.

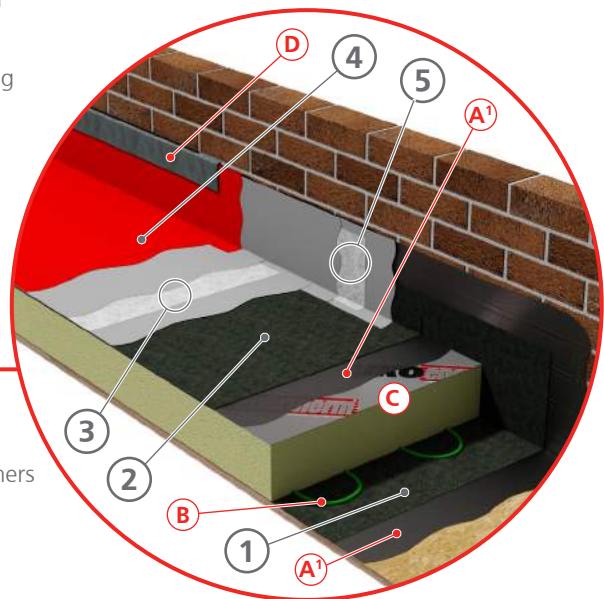

	Membrane	Description	Weight	Size	Coverage Rate	Surface Finish
①	Vapour Control Layer	IKO Systems Self-Adhesive VCL	36kg (roll)	15x1m	/	Fine Minerals
②	Preparation Membrane	IKO Polimar Self-Adhesive Preparation Membrane	36kg (roll)	16x1m	/	Fine Minerals
③	Main Field Waterproofing (IKO Polimar FCS Waterproofing; 2x Coats with Reinforcement Fleece)	IKO Polimar FCS Waterproofing or IKO FCS Polimar Low Odour Waterproofing	10kg (drum)	/	Substrate Type: - Smooth: 2.5kg/m ² - Fine grained: 3kg/m ² - Rough: 3.5kg/m ²	Dark Grey
		IKO Polimar FCS Reinforcement Fleece (Polyester)	100gsm (roll)	1.05x50m		/
④	Top Coat	IKO Polimar FCS Sealer Coat	10kg (drum)	/	0.5kg per m ²	Light Grey, Mid Grey, Dark Grey
⑤	Detailing (IKO Polimar FCS Detailing; 2x Coats with Detailing Fleece Reinforcement)	IKO Polimar FCS Detailing	10kg (drum)	/	Substrate Type: - Smooth: 2.5kg/m ² - Fine grained: 3kg/m ² - Rough: 3.5kg/m ²	Dark Grey
		IKO Polimar FCS Detailing Fleece (Polyester)	100gsm (roll)	1.26x50m		/

Notes: Primers are not normally required but metal, porous surfaces and other specific substrates may require priming. Adhesion test may be required on certain surfaces. See IKO Polimar FC Primers Page 117.

Complementary Products			
Ⓐ	Primer	A ¹ - IKOpro Systems Bonding Agent	Page 101
		A ² - Other IKO FCS Polimar primers and preparation products (not shown)	Page 117
Ⓑ	Adhesive	IKOpro Sprayfast IBA; PU adhesive for insulation board	Page 102
Ⓒ	Insulation	IKO enertherm ALU; high-performance PIR insulation board	Page 92
Ⓓ	Flashing	IKOflash Lead-Free Flashing	Page 115

Additional Information



IKO Polimar FCS Sealer Coat Standard Colours		
Light Grey	Mid Grey	Dark Grey*

Certificates & Accreditations	
Fire Performance	EXT.F.AC in accordance with BS 476-3
BBA	Agrément Certificate 14/5178
NHBC	Accepted

* Other colours based on the BS4800 or RAL Colour System are available on order. The printed colours are as accurate as possible, but are for guidance purpose only. RAL reference numbers represent the nearest colours and are not exact matches to all IKO Polimar coatings.



The IKO Polimar EC/UV System is available in both 15 and 20 year designed solutions. This premium system is highly flexible in its design and is suitable for all roof types including warm, inverted and full overlay colour applications.

The high-performance polyurethane resins are extremely durable and puncture resistant and the manageable sized packaging of the products are ideal for areas of limited access.

System Benefits



- Premium performance
- Excellent durability and puncture resistance
- Highly flexible in design application
- Wet-on-wet EC application saves time
- For new construction or refurbishment projects
- Suits most roof types
- Applicable for full overlay installations
- Can be applied to existing sound substrates
- Simplifies complex detailing
- Up to 20 year designed solutions
- Slip resistant option for maintenance walkway and private balconies.

IKO Polimar EC/UV Roofing System

IKO Polimar EC is a high-performance, high-build polyurethane embedment coat. It incorporates moisture triggered curing technology that forms the base layer of the IKO Polimar EC/UV System. With excellent fluid properties for ease of application, this provides a cost effective, high solids coat that offers superb adhesion.

The flat roof is reinforced with the IKO Polimar GRF (Glass Fibre Reinforcement Fleece) giving the system strength and stability on a flat substrate.

IKO Polimar UV is an elastomeric, high build single component polyurethane UV stable top coat which comprises a blend of moisture triggered polyurethane resins. Once applied, the cured membrane forms a seamless durable waterproof barrier which provides excellent thermal and UV stability for all climatic conditions.

In addition the IKO Polimar EC/UV System can incorporate a fully integrated slip resistant finish for private balconies and fire escapes.

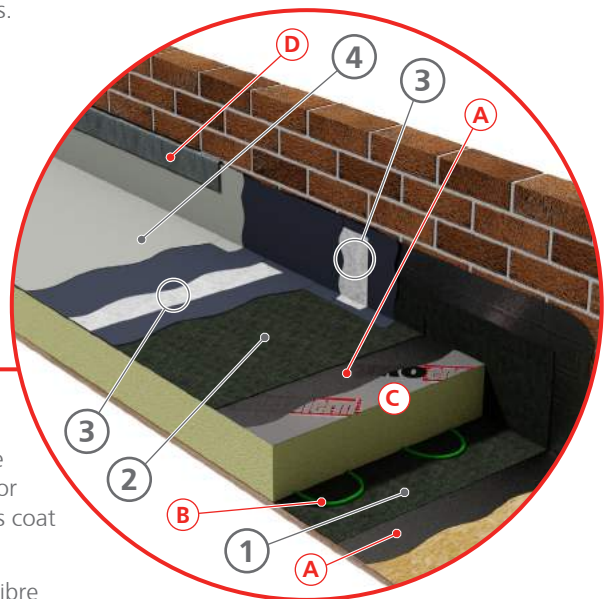

	Membrane	Description	Weight	Size	Coverage Rate	Surface Finish	
①	Vapour Control Layer	IKO Systems Self-Adhesive VCL	36kg (roll)	15x1m	/	Fine Minerals	
②	Preparation Membrane	IKO Polimar Self-Adhesive Preparation Membrane	36kg (roll)	16x1m	/	Fine Minerals	
③	Main Field Waterproofing & Detailing (IKO Polimar EC Waterproofing; 2x Coats with Reinforcement Fleece)	15 Year	IKO Polimar EC	12.5ltr (drum)	/	1.2ltr/m ²	Black
			IKO Polimar GRF Reinforcement	100gsm (roll)	100x1m	/	White
			IKO Polimar GRF Detailing Strip	100gsm (box)	0.25x1m	/	White
		20 Year	IKO Polimar EC	12.5ltr (drum)	/	2.0ltr/m ² wet on wet	Black
			IKO Polimar GRF Reinforcement	225gsm (roll)	100x1m	/	White
			IKO Polimar GRF Detailing Strip	225gsm (box)	0.25x1m	/	White
④	Top Coat	IKO Polimar UV Top Coat	12.5ltr (drum)	/	0.5ltr/m ²	Mid Grey, Dark Grey, Copper Green, White	

Notes:

Primers: Primers are not normally required but metal, porous surfaces and other specific substrates may require priming. Adhesion test may be required on certain surfaces. IKO Polimar GP Primer is recommended on rough substrates. See IKO Polimar Primers Page 121.

Waterproofing: The coverage rates quoted are typical values for the type of surface indicated – more material will be required where the surface condition of the substrate is variable - Full embedment of the glass reinforcement fleece (GRF) must be achieved in all cases.



Reinforcement: All flat roofs must be fully reinforced with IKO Polimar GRF. Additional localised reinforcement using IKO Polimar KRM, (fully saturated in IKO Polimar EC) and IKO Polimar Bridging Tape will be required over joints and other areas where movement may be expected. See IKO Polimar accessories Page 123.

Top Coats: The coverage rates quoted are the minimum required for each system.

Complementary Products			
Ⓐ	Primer	IKOpro Systems Bonding Agent	Page 101
Ⓑ	Adhesive	IKOpro Sprayfast IBA; PU adhesive for insulation board	Page 102
Ⓒ	Insulation	IKO enertherm ALU; high-performance PIR insulation board	Page 92
Ⓓ	Flashing	IKOfash Lead-Free Flashing	Page 115

Additional Information



UV Top Coat Standard Colours *	
	
Mid Grey	Dark Grey

Certificates & Accreditations	
Fire Performance	EXT.F.AA rating in accordance with BS 476-3
NHBC	Accepted
ETA Certificate	ETA-13/0168

* Other colours based on the BS4800 or RAL Colour System are available on order. The printed colours are as accurate as possible, but are for guidance purpose only. RAL reference numbers represent the nearest colours and are not exact matches to all IKO Polimar coatings.



**complementary
membranes**

Complementary Membranes



All the elements you need for the complete flat roofing solution, all available from IKO.

The quality of any flat roof relies on much more than just the cap sheet. For any built-up roofing system to provide outstanding protection for its expected service life, it needs a solid and reliable foundation – which is why IKO offer an unrivalled range of vapour control layers, underlays and specialist membranes.

IKO Systems Vapour Control Layer

While the risk of condensation is greatest in high-humidity areas such as swimming pools and textile factories, even schools, offices and flats can produce enough humidity to cause condensation within the roof structure. As an essential part of any warm roof build up, these membranes are placed beneath the insulation to control the passage of water vapour and reduce the risk of condensation. IKO's range of high-performance metal lined vapour control layers are highly effective with excellent mechanical properties.



System Benefits

- Aluminium core
- High tensile polyester base
- SBS bitumen coating - low temperature flexibility (-20°C)
- Prevents penetration of water vapour and damage to roof construction
- Torch-on or self-adhesive options.

IKO Systems S-A Vapour Control Layer (Self-Adhesive)

A high-tensile polyester reinforced, SBS self-adhesive coated, aluminium lined vapour control layer with a fine mineral finish. The membrane has a removable release film on the underside. To help seal side laps it has a minimum 75mm selvedge free of surface coating, protected by a release film strip which should be removed before overlapping.

IKO Systems T-O Vapour Control Layer (Torch-On)

This VCL has an impervious aluminium core reinforced with high-tensile polyester and coated with a specially formulated quick melt SBS modified bitumen. The lower surface has a thermofusible film which rapidly melts during torching.

Membrane	Description	Weight	Size	Base Carrier	Surface Finish
Vapour Control Layer	IKO Systems Torch-On Vapour Control Layer	37kg (roll)	12x1m	Polyester	Fine Minerals
	IKO Systems Self-Adhesive Vapour Control Layer	38kg (roll)	15x1m	Polyester	Fine Minerals



Complementary Membranes

IKO Systems Underlay Layer

Many of IKO's built-up roofing systems include a high-performance underlay to add strength and waterproofing security to the overall system. IKO Systems Underlay Membranes incorporate a tough polyester reinforcement base and SBS modified bitumen, with a full range of application types including torch-on, pour and roll and self-adhesive.



System Benefits

- High-tensile polyester base
- High-resistance to damage and delamination
- SBS bitumen coating offering excellent low temperature flexibility
- Range of application methods to suit project requirement

IKO Systems S-A Underlay (Self-Adhesive)

An elastomeric self-adhesive underlay with robust polyester reinforcement for greater durability and a fine mineral upper surface, ideal for bonding subsequent cap sheets. The release film backing to the underside and selvage should be removed during installation, and all side and end laps are heat bonded for a watertight seal.

IKO Systems T-O Underlay (Torch-On)

Using a polyester carrier coated with SBS rubber modified bitumen, this underlay's upper surface is finished with fine sand while the lower surface has a thermofusible film which rapidly melts during torching.

Membrane	Description	Weight	Size	Base Carrier	Surface Finish
Underlay	IKO Systems Self-Adhesive Underlay	33kg (roll)	16x1m	Polyester	Fine Minerals
	IKO Systems Torch-On Underlay	38kg (roll)	12x1m	Polyester	Fine Minerals

IKO Roofgarden

IKO Roofgarden is a high-performance cap sheet consisting of a polyester base, coated with APP polymer modified bitumen. The bitumen coating contains a specially formulated anti-root treatment, which prevents the penetration of roots from a range of plants and shrubs.

IKO Roofgarden is used as the top layer to reinforced bitumen membrane systems, IKO Roofgarden can be used with IKO approved specifications in both extensive and intensive roof garden situations.



System Benefits

- Achieves FLL 4-Year root penetration test
- Purpose made roof garden waterproofing cap sheet
- Specifically formulated 'Anti-Root' coating
- Flexible down to -20°C
- Excellent adhesion to substrate
- Polyester base - high tensile strength, rot proof and puncture resistance
- High resistance to damage and delamination

Membrane	Description	Weight	Size	Base Carrier	Surface Finish
Cap Sheet	IKO Roofgarden Torch-On APP Cap Sheet	46kg (roll)	7.5x1m	Polyester & Glass	Dark Grey

IKO Polimar Preparation Membrane

IKO Polimar Preparation Membrane is an SBS modified bitumen based glass-reinforced self-adhesive membrane with a 100mm selvedge, a release film backing and a fine mineral surface finish.

The IKO Polimar Preparation Membrane is used when IKO Polimar has been specified to be installed on very rough concrete surfaces, or to bridge joints in insulation boards and panelled joints, prior to the application of the IKO Polimar Liquid Applied Roofing System.



Membrane	Description	Weight	Size	Base Carrier	Surface Finish
Preparation	IKO Polimar SBS Self-Adhesive Preparation Membrane	36kg (roll)	16x1m	Glass	Fine Minerals



**design
considerations**

Design Considerations



The specification and design process is critical to be sure of long-term, good quality roof protection that meets the requirements of Building Regulations.

A roof performance is dependent upon material specification, correct design detailing and installation by fully trained operatives, followed up with regular inspection and maintenance.

Your roof is one of your most valuable assets and it is therefore important to be confident that you have made the right choice from the very start.

IKO take great care in providing services and products that offer clients and specifiers effective and positive solutions to meet guidelines set in CDM regulations (Construction Design Management), Codes of Practice set by British Standards, Building Regulations, including Part L, Government Guidelines and BREEM (British Research Establishment Environmental Assessment Method).

IKO offer an extensive consultation service regarding design, specification and material selection. This service is delivered via a national team of regional design specialists and head office based technical services.

The roofing system design should generally take into account the following factors:

- Geographical location of the building
- Degree of exposure (wind etc.)
- Roof deck/structural support
- Pitch (angle of slope)
- Intended usage (roof garden, walkway etc.)
- Roof falls and drainage
- Thermal performance (condensation)
- Fire performance
- Construction fabric (flammable or fragile etc.)
- Perimeter detailing aspects
- Roof penetrations (rooflights etc.)
- Roof mounted plant and equipment
- Building occupancy levels and type of occupancy (during work and for maintenance)
- Roof access arrangements (during work)



Further information on roof design can be found at www.ikogroup.co.uk
IKO Technical Department is available to give specific project design advice on **01257 256 864**

The three principle designs of flat roofing construction

Warm Roof

In a warm roof construction the insulation is placed immediately below the waterproofing membrane and above the vapour control layer (VCL), which is bonded to the deck. This is the most practical configuration for controlling condensation and usually recommended for insulated roof design.

In a warm roof, a metal lined bituminous vapour control layer offers the highest performance, as required over high humidity environments (e.g. swimming pools). It is essential that the VCL is properly attached to the substrate, and all sides and end laps are fully sealed.

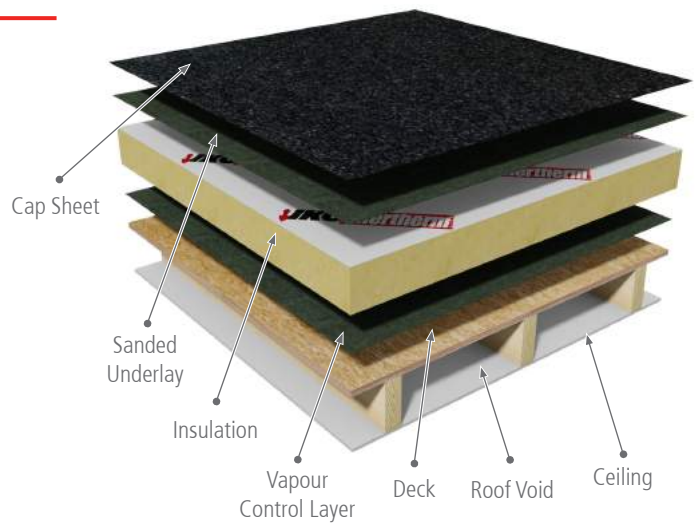

Cold Roof

This flat roof configuration places insulation within a ventilated void space below the roof deck and above the internal ceiling - This form of roof design is no longer recommended, as proper ventilation and effective vapour control at ceiling level are difficult to achieve. Other hybrid roofs sometimes have insulation both above the deck and inside an internal void (below the deck). This can result in serious condensation problems unless the insulation thickness above and below the deck can be balanced. Depending on internal humidity, this can be impossible to achieve, in which case this type of hybrid roof is not recommended.

Composite insulated decking panels are also available. These must be installed strictly according to the manufacturer's instructions, and their use over high humidity areas will often be restricted.

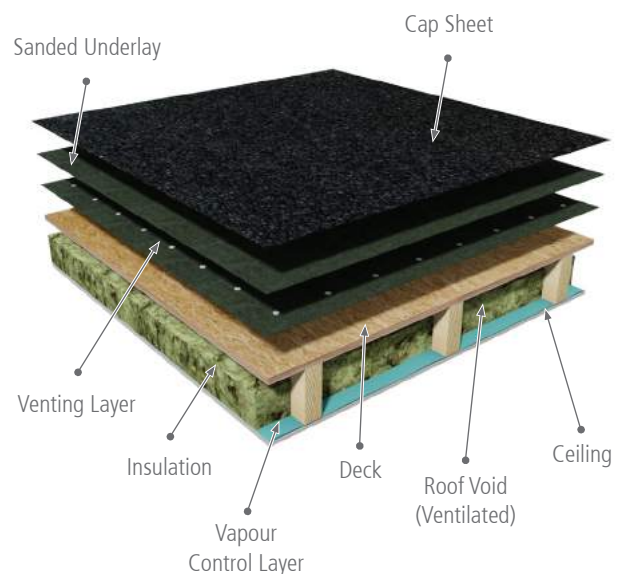

Inverted Roof

Where extruded polystyrene insulation is placed above the waterproofing layer and loaded with ballast, paving slabs or roof garden finishes. This is a satisfactory roof design, particularly where a roof finish will receive pedestrian and other traffic. However, greater thickness of insulation is needed to allow for the cooling effect of water draining beneath insulation and the supporting structure must be designed to accommodate the additional loading required for the insulation.

An inverted roof needs no additional vapour control layer, as the waterproofing also performs the function of the VCL.

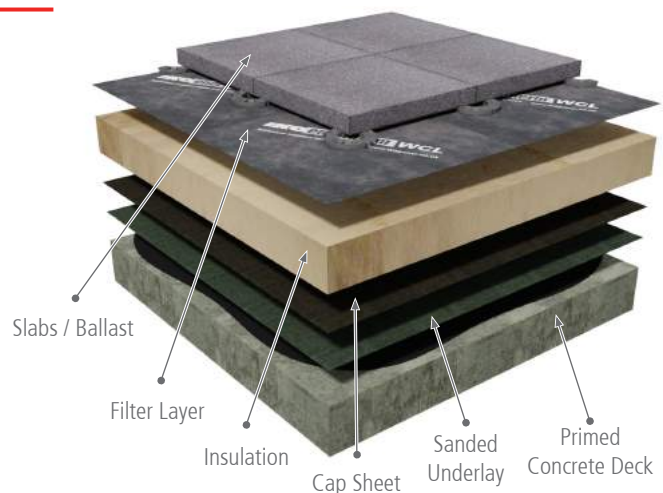

Design considerations

Roof decks



Structural decks provide the primary support for the roofing system. They must resist dead, live and wind loads including storms. They must also be suitable for the proposed membrane roofing system, and the subsequent use that the roof has been designed for.

Relevant structural and loading codes for each material must be followed, and current Building Regulation requirements checked and observed. If the use of an existing roof is to be changed (e.g. retrofit roof garden or pedestrian roof patio area), the suitability of the deck and the supporting structure must be confirmed.

The deck may also be laid or fixed to provide a suitable fall for drainage of the roof surface, as required in BS 6229: 2003, Code of Practice for flat roofs with continuously supported coverings. However, roof falls can also be provided by the addition of tapered insulation as part of a roofing contract.

Roof designers of refurbishment projects should also still be aware of strawboard (Stramit) decking, used widely in the 1950's and 1960's. Strawboard was a combined decking and insulation material, comprising compressed straw with brown paper facings.

The product loses all structural integrity if wetted and removal of bonded membranes will destroy the upper face, and hence destroy the structural strength. The only course of action is to strip and replace strawboard with a suitable durable timber panel deck.

In addition to the above, any type of wood chipboard is unsuitable for flat roofing, and is not recommended under roofing Codes of Practice.

The most common types of flat roof structural deck:

- In-site concrete decks
- Pre-cast concrete decks
- Timber-based panels
- Plywood decks
- Oriented strand board (OSB types 3 or 4 only)
- Woodwool decks (no longer manufactured but may be present on existing structures)
- Profiled metal decking
- Composite insulated panels

Design to falls



It is generally accepted as good practice for flat roofs to be designed to clear surface water. Flat roofs should be constructed to a minimum finished fall of 1 in 80.

To achieve this, the designer needs to adopt a design fall which will allow for deflections and inaccuracies in construction. BS 6229: 2003 recommends 1 in 40 as the design fall, to ensure a finished fall of at least 1 in 80. An alternative approach is to choose an immediate figure of 1 in 60, which is usually sufficient. The design of falls and drainage patterns will have a considerable influence on the depth of the total roof construction or roof zone, which should be a fundamental consideration at the very earliest stages of conception of a building. It is only after assessing the depth of roof zone that the designer can decide the levels of all other aspects of the construction above the level of the flat roof (e.g. wall DPC's, window/door abutments etc).

Falls may be formed in the structure or can be created within the roofing system above the deck. Falls in the structure can be achieved by adjusting the height of supporting beams or purlins, by using tapered supports, or by the additions of furring pieces before the deck is laid. The latter method is normally used with decks such as woodwool, timber, pre-cast concrete and metal decking.

In the case of an in-site cast concrete slab, falls are normally provided by using a separate screed.

Preformed tapered insulation boards also provide a useful method of forming falls on a level roof deck. IKO is able to design and supply suitable tapered insulation systems. These provide both insulation and falls and are of particular importance for re-roofing existing roofs, many of which do not have sufficient falls and probably do not have sufficient insulation.

Tapered insulation can provide falls in one direction to a gutter or level valley, or in two directions to form falls and cross falls. In some circumstances it may be deemed necessary to control the rate of water run-off from flat roofs and paved areas to avoid overloading ground drainage. Where this is a requirement, consideration should be given to using green roofs or roof top gardens where horticultural finishes can be used to absorb rainfall and release it into surface water drainage more slowly. However, it is still important to make the correct provision for adequate drainage, even with garden roofs, to avoid water-logging the growing medium or overloading the structure.

Roof drainage



Flat roofs may be drained by two basic methods: towards the outer edges and into external gutters, or towards internal gutters or outlets within the main roof area.

Straight falls to external gutters are simple to form by sloping the roof deck with firrings, by screeding or by using tapered insulation boards. Internal drainage will be achieved by straight falls to the guttering or a pattern of falls and cross falls to outlets.

Control of condensation



When designing a roof the potential for condensation must always be considered. Any provision required to control condensation should be determined as recommended in BS 6229, 2003 but with the calculation method modified to conform to BS 5250, Code of Practice for control of condensation in buildings.

The IKO Technical Services Department can undertake these calculations to ensure the optimum thermal performance of a roof is achieved.

Suitable thermal insulation should be included within the system. This layer must have sufficient insulation value for its underside to remain above the temperature at which condensation can start, even in the coldest design conditions. The provision of insulation alone, however, may not be sufficient to prevent condensations. If the insulation is permeable to water vapour, the vapour will pass upwards through it and condense on the underside of the waterproof membrane. To prevent this occurring, a vapour control layer should be provided directly below the insulating layer.



Insulation



The statutory requirements for the thermal performance of buildings are set out in the Building Regulations Part L (2010 edition). The new Part L is published in four sections:

- L1A: New Dwellings
- L1B: Existing Dwellings
- L2A: New Buildings other than Dwellings
- L2B: Work in existing buildings other than Dwellings.

IKO supply a comprehensive range of totally CFC/HCFC free rigid thermal insulation boards suitable for use with IKO Flat Roofing systems. IKO insulation materials come in a range of uniform thickness or in tapered form, to suit individual circumstances and U-value requirements. (See page 93).

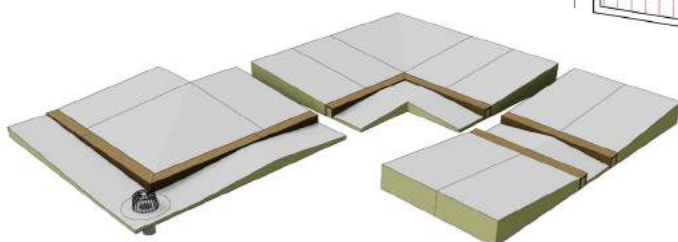
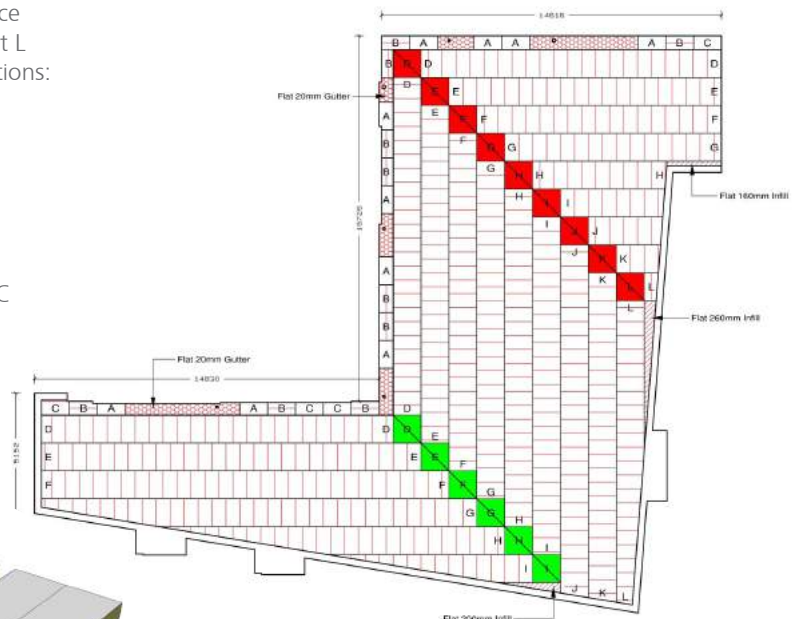



Routine Inspections

Regardless of the manufacturer concerned, all flat roofs should be inspected twice yearly, preferable in the spring and autumn, and/or after extremes of weather conditions. Inspections should be carried out generally in accordance with BS 6229: 2003.

Particular attention paid to the following items:

- It is important to check that roof outlets are functioning and gratings are not blocked. Remove debris from the roof but do not flush silt or dead leaves down outlets. In areas where taller trees are adjacent to the roof, inspections may be required more frequently
- Note the general condition of the membrane finishes and report any signs of creasing/blistering, de-bonded laps or damaged areas immediately
- Check the perimeter details and upstands, ensuring that metal cappings, flashings, edge trims and mortar pointing to chase details are secure
- Check waterproofing to rooflight kerb
- Check rooflight domes for signs of damage or deflection
- Check flashing to expansion joints and that cappings are secure
- Check upstand flashings to plant support legs/ upstands
- Check upstands and flashings to pipe penetrations
- Examine all mastic seals and repair/replace as necessary
- Check walkways and around access points to ensure damage/displacement has not occurred to walkway or concrete paving.

Routine Maintenance

As with all roofing systems, proper maintenance is essential to obtain maximum performance and ensure the longest life expectancy of the system as a whole. It is also an integral part of all manufacturers guarantees.

Any deficiencies should be reported immediately to IKO.

Access to the roof must only be allowed by arrangement with and under supervision of the Building Manager or the person responsible for building maintenance, in accordance with the **Construction (Design & Management) Regulations 2015**.

All personnel given permission to access the roof must be fully advised of the health and safety procedures required by the site or that of the individual roof concerned. The client or building owner is responsible for providing safe access to and from the roof, and for suitable edge protection or fall arrest systems.

Repair Work

Roofs which are under guarantee by IKO should only be repaired by the installing contractor, with full design reference to the IKO Technical Services Department.

Where the roof is not covered by a guarantee, Clause 10.3 to BS 8217: 2005, 'Repair Procedures' should be applied.



Additional reference



British/European Standards

BS 8748: 2007
Reinforced Bitumen Membranes (RBMs) for roofing.
Guide to selection and specification.

BS 6229: 2003
Code of Practice for flat roofs with continuously supported coverings.

BS8217: 2005
Reinforced Bitumen Membranes for roofing.

BS EN 12056: 2000
Gravity drainage systems inside buildings.
Sanitary pipework, layout and calculation.

BS 5250
Code of Practice for control of condensation in buildings.

BS 8000 Part 4: 1989
Workmanship on building sites. Code of practice for waterproofing.

BS 476 Part 3: 2004
Fire tests on building materials and structures.
Classifications and method of test for external fire exposure to roofs.

Websites

National Federation of Roofing Contractors
www.nfrfc.co.uk

British Board of Agreement
www.bbacerts.co.uk

Building Research Establishment
www.bre.co.uk

Loss Prevention Certification Board (Red Book)
www.redbooklive.com

Health and Safety

Health and Safety Data sheets relating to all IKO materials are available from the IKO Health, Safety and Environmental Department on **01257 255 771** or as a download from **www.ikogroup.co.uk**.

Building Regulations

www.planningportal.gov.uk/england/professionals/en/
Approved Document A 2004 – Structure
Approved Document B – Volumes 1 and 2 (2006 edition) – Fire Safety
Approved Document C 2004 – Resistance to Contaminants and moisture
Approved Document H 2000 (2002 amendment) – Drainage and Waste Disposal
Approved Document L1 and L2 2000 (2010 amendment) – Conservation of Fuel and Power



Further information on roof design can be found at **www.ikogroup.co.uk**
IKO Technical Services Department is available to give specific project design advice on **01257 256 888**

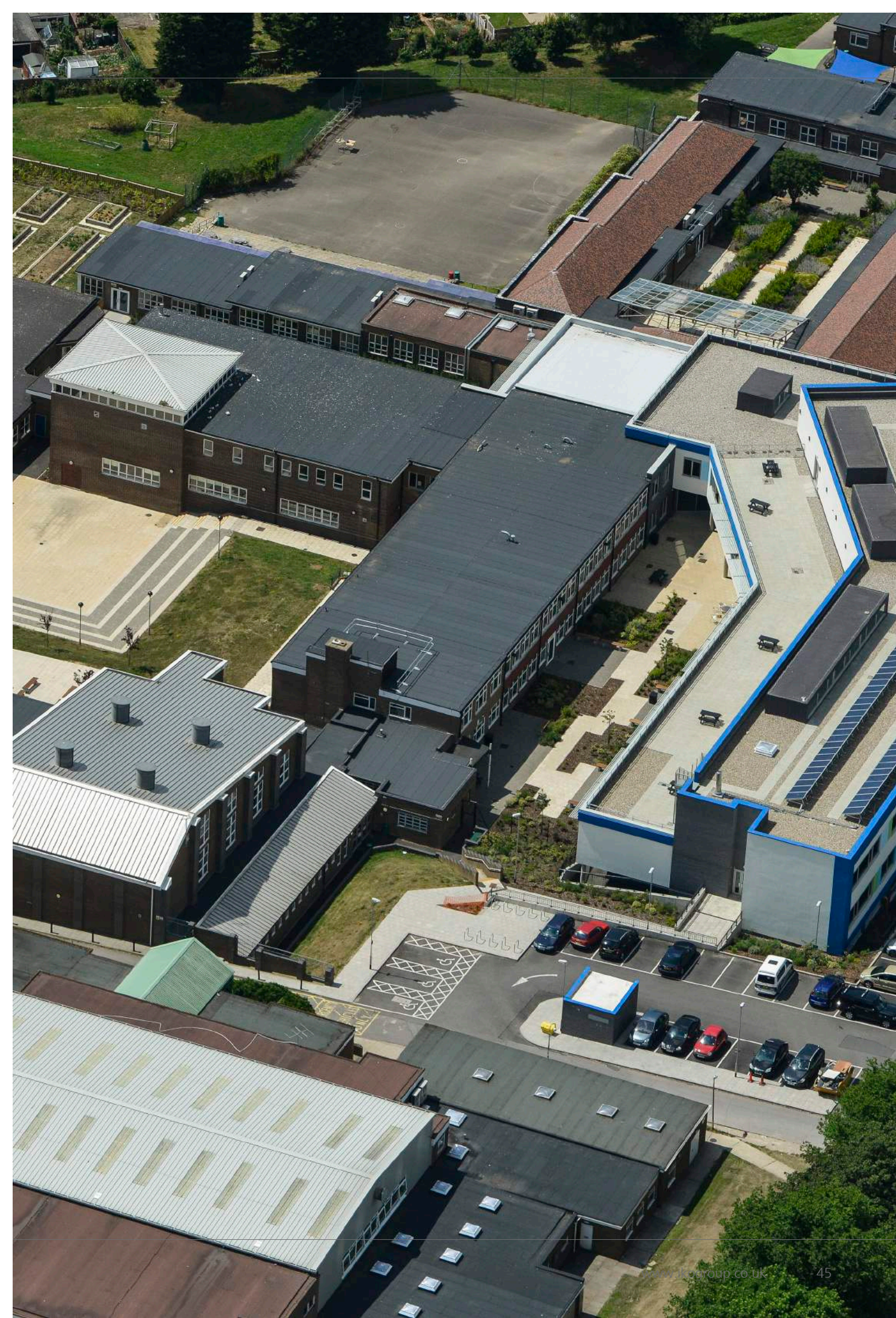

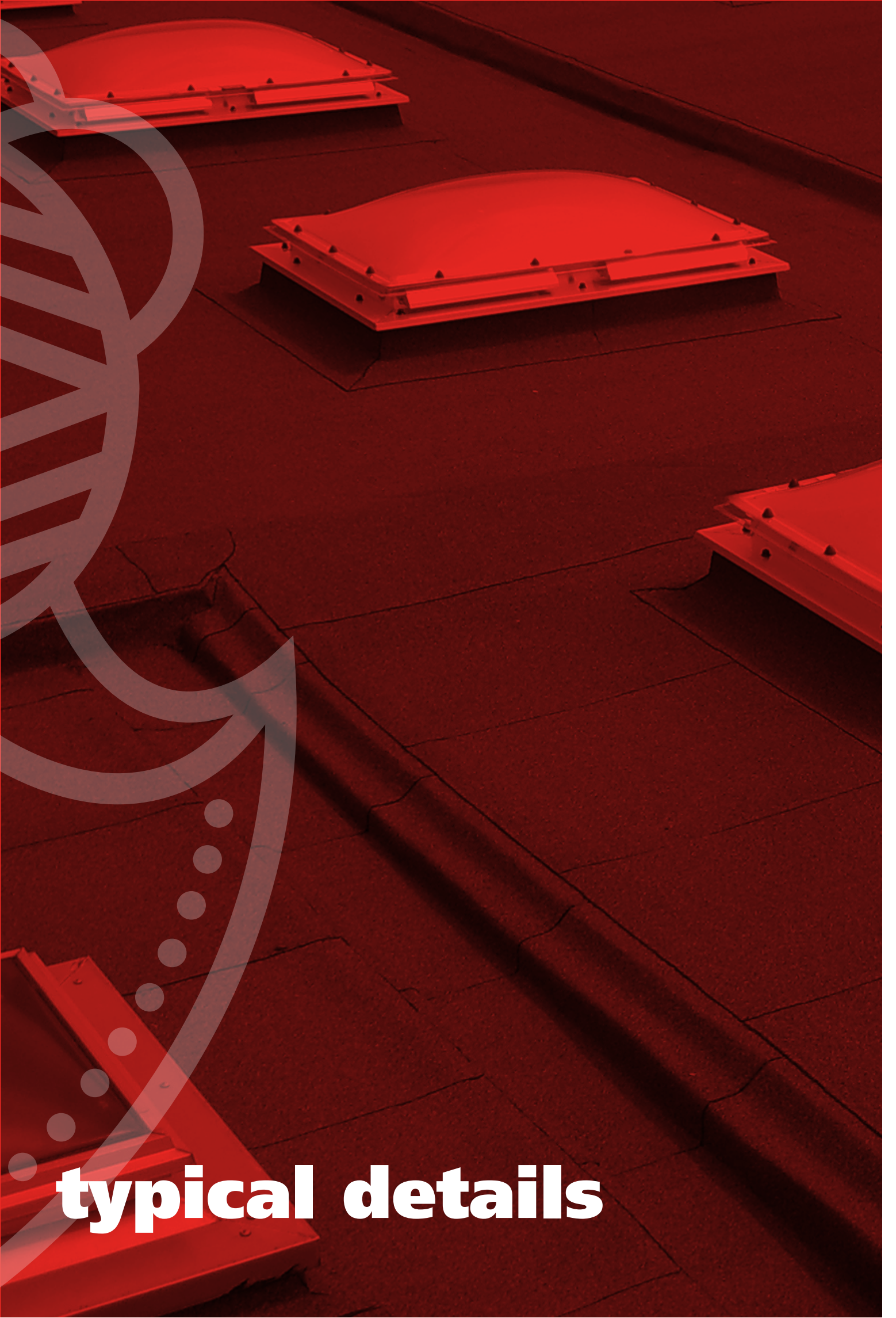

typical details



Insulated Uprand

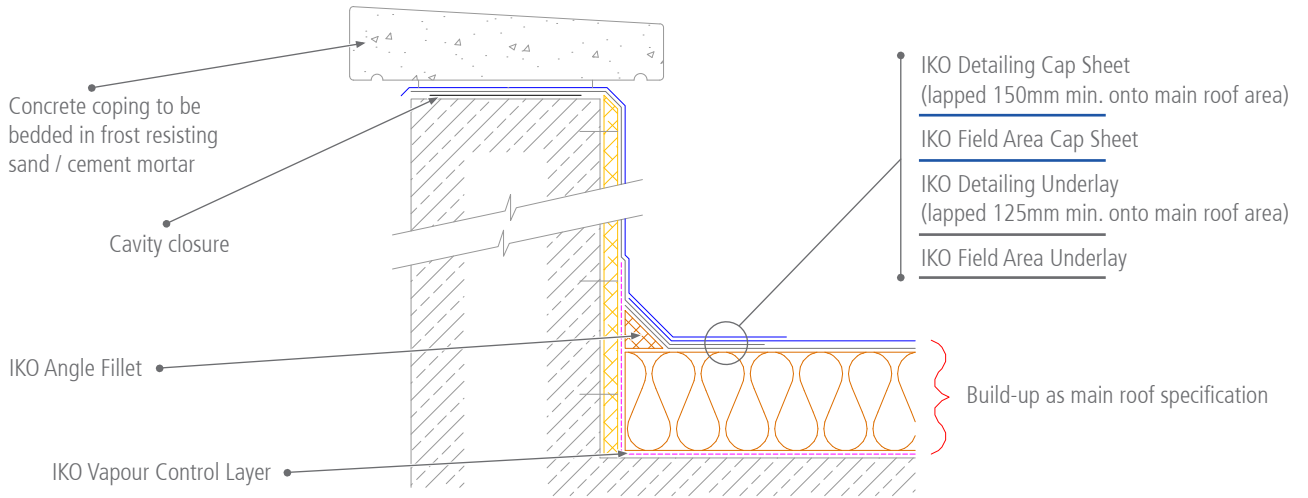

Timber Check Kerb

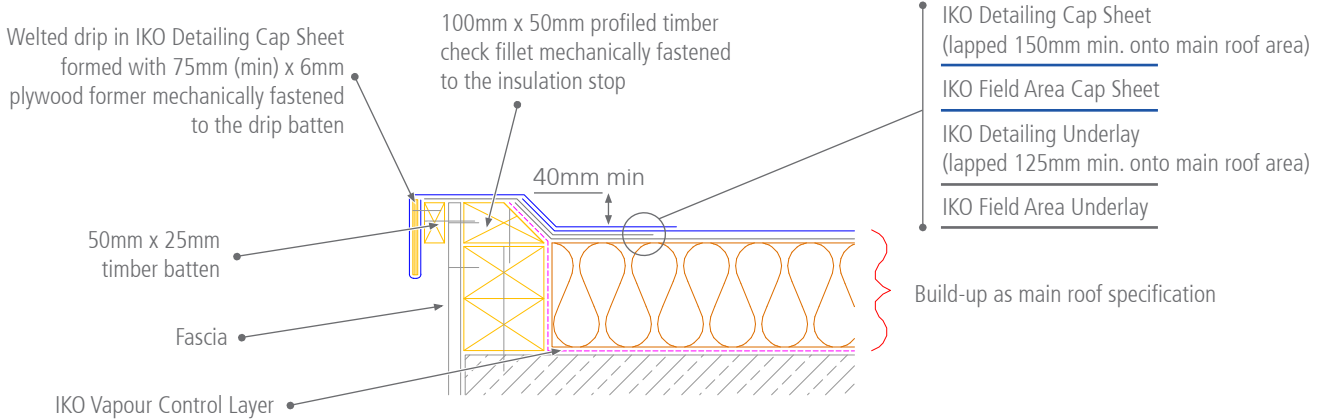

Insulated Gutter

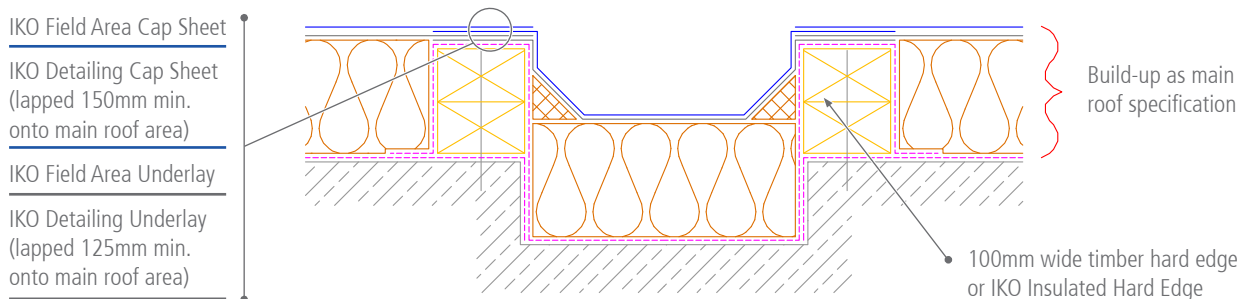



Typical detail

Welted Drip

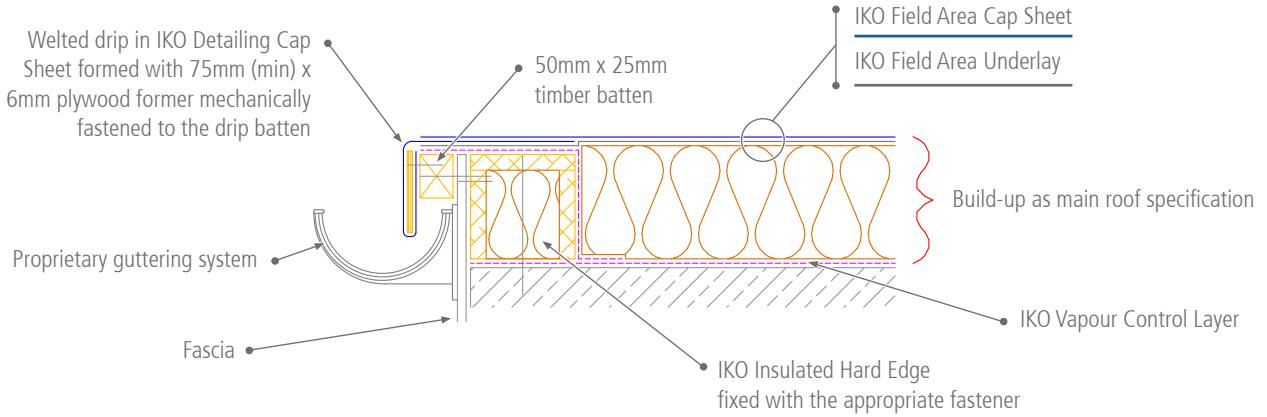

Rainwater Outlet

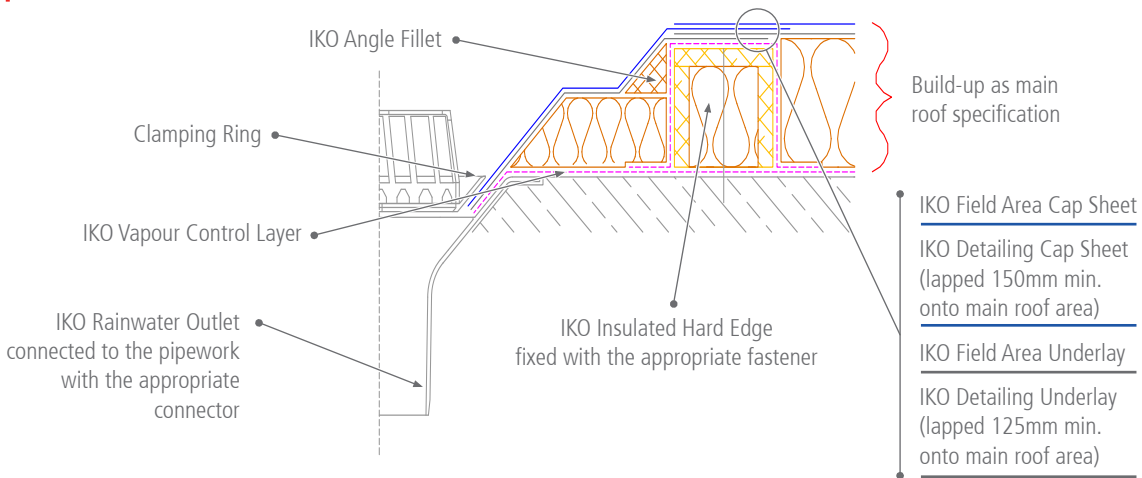

Rooflight

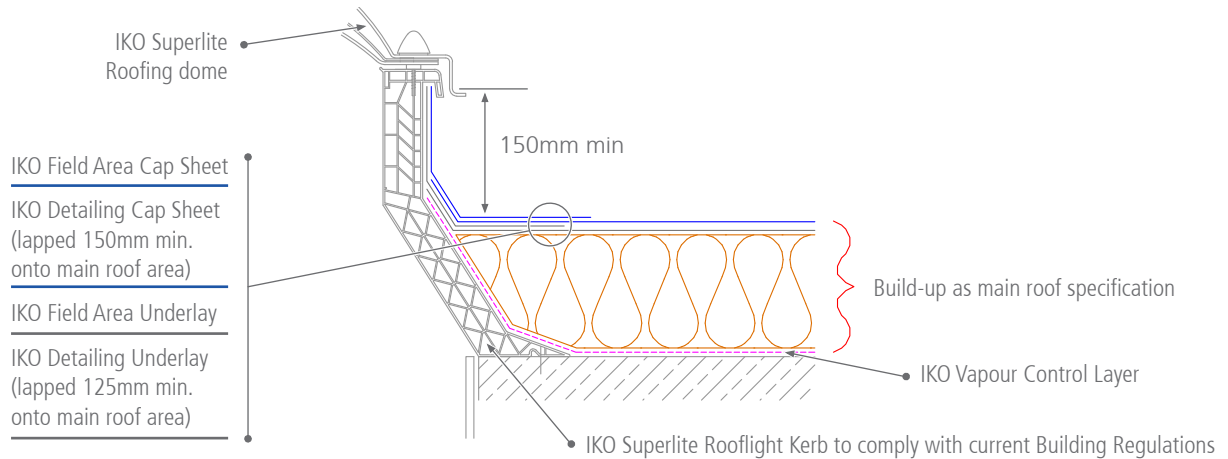



Pipe Detail

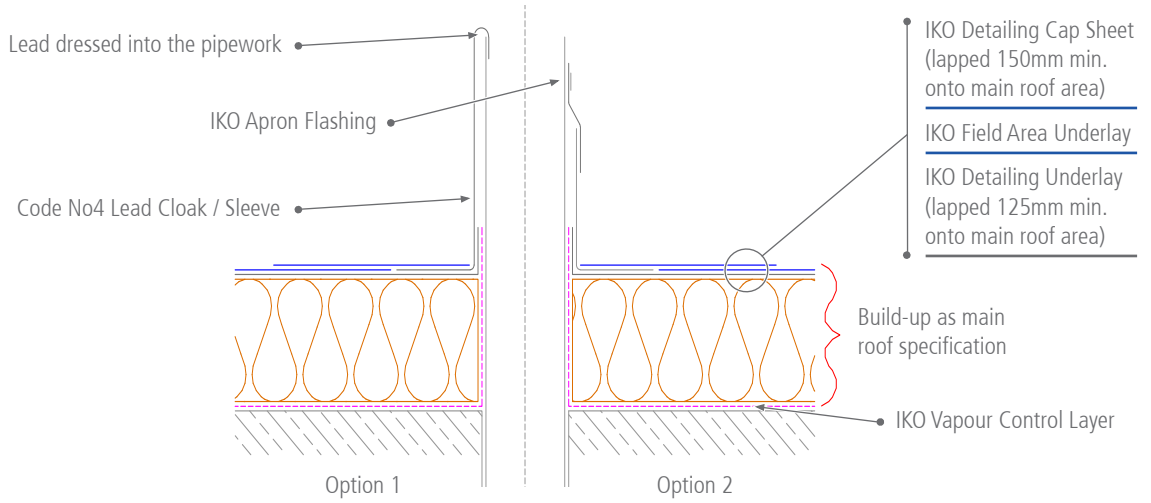

Vertical Cladding Detail

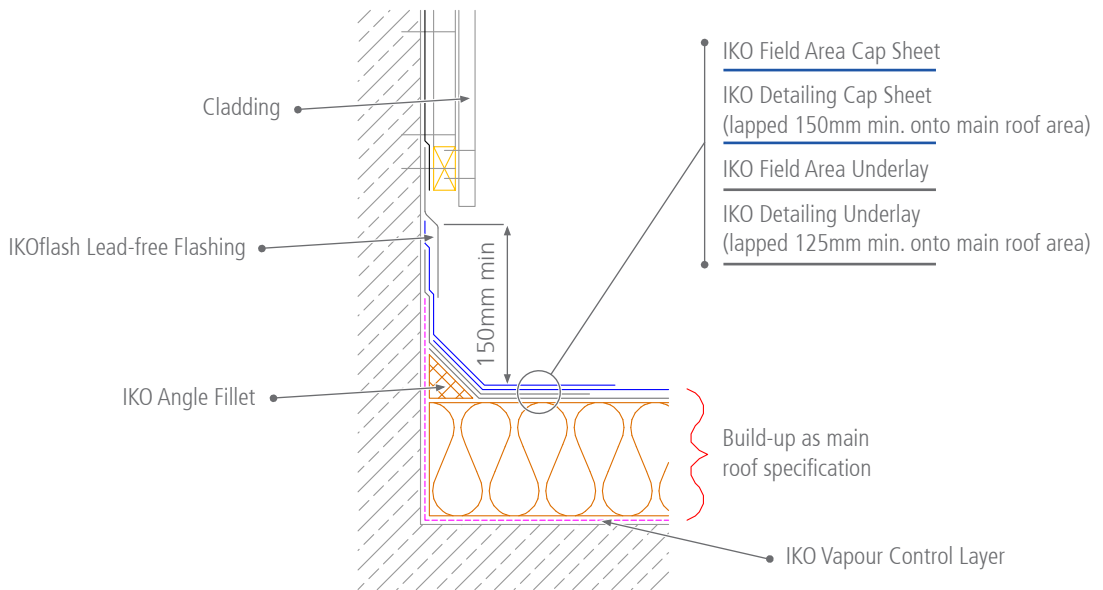

These pages show a selection of typical drawings
For a full range contact IKO Technical Department on **01257 256 864**

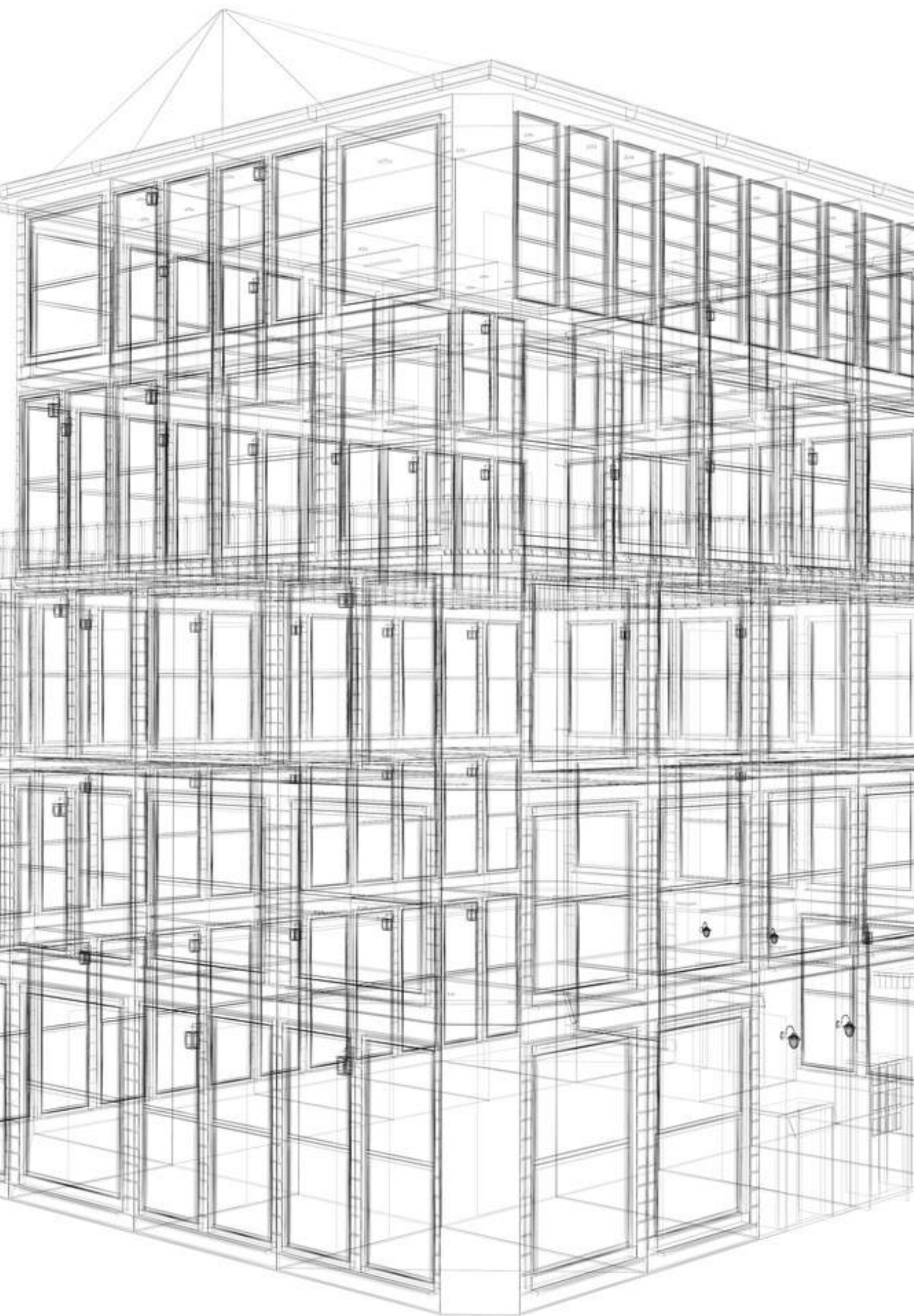

balconies & walkways

Cold Applied Liquid Waterproofing

53







IKO Polimar (Fast Curing System) FCS Balcony & Walkway Systems

IKO Polimar FCS Balcony and Walkway System is a fast curing, highly durable and flexible, slip resistant waterproofing coating for both refurbishment and new build projects.

The system is a high-performance coating with fast curing properties reducing the installation time to hours rather than days, ideal when working in areas with regular foot traffic. Once applied IKO Polimar FCS is waterproof, UV resistant, seamless, and resistant to dilute acids and alkalis, oil, petrol and diesel.

Applications

IKO Polimar FCS is designed for a wide range of applications including:

- Balconies & walkways - pedestrian ramps
- Stairs - driveways
- Railway platforms - cycle paths

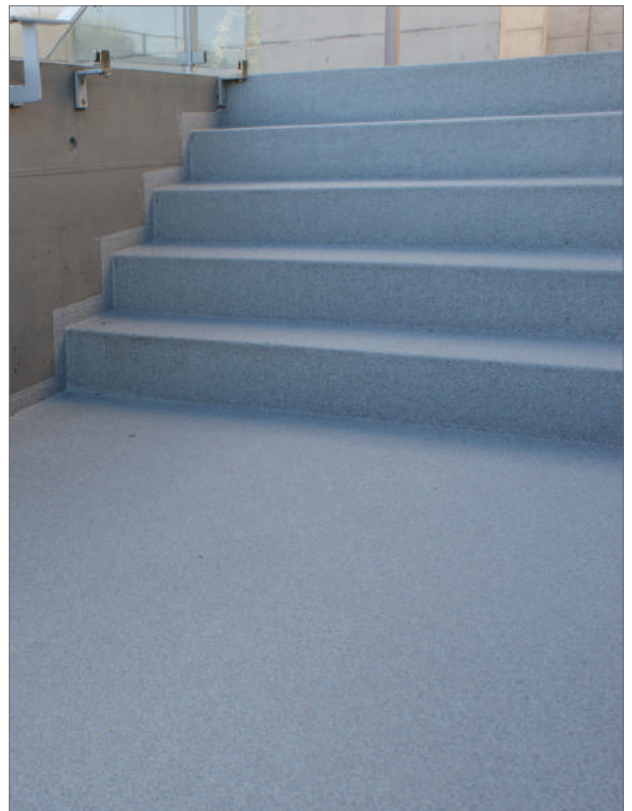



IKO Polimar FCS Balcony and Walkway Waterproofing System is a fast-curing, highly-durable and flexible, slip-resistant waterproofing coating capable of withstanding mechanical stresses.

This innovative system is a seamless, minor crack-bridging and joint-bridging waterproofing system that is able to withstand typical mechanical stresses. It contains a highly flexible and fleece-reinforced waterproofing layer as well as abrasion-resistant system layers for foot traffic. The waterproofing system's liquid application and high-bonding strength on almost any substrate also allows breakthroughs and upstands to be integrated securely and seamlessly. These properties make the system a cost-effective solution for balconies and walkways, especially for refurbishment projects.

IKO Polimar FCS layers cure in 20 to 30 minutes, and the system is trafficable after 45 minutes.



System Benefits

- Fully reinforced
- Rapid curing times, same day return to full service
- Excellent chemical resistance
- Slip-resistant technology
- Self levelling for ease of application
- Hygienic and easily cleaned
- Year round application possible
- Excellent waterproofing performance
- Additional surface coat in any RAL colour available
- BBA Agrément Certificate 14/5178 - durability of 25 years
- 20 minute cure time per coat

IKO Polimar FCS Balcony & Walkway (Asphalt on concrete deck) 15 year system

IKO Polimar FCS is a 2-pack system based on high performance resin. The system consists of a primer, a 3mm self-levelling wear course with a hard wearing slip resistant aggregate, and a sealing top coat.

All detailing and penetrations are required to be waterproofed using IKO Polimar FCS Detailing fully reinforced with IKO Polimar FCS Detailing Fleece.

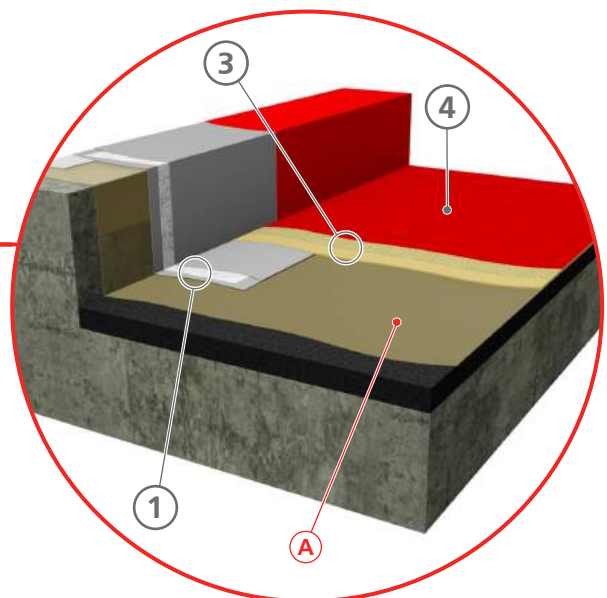

Timber Deck - 20 year system

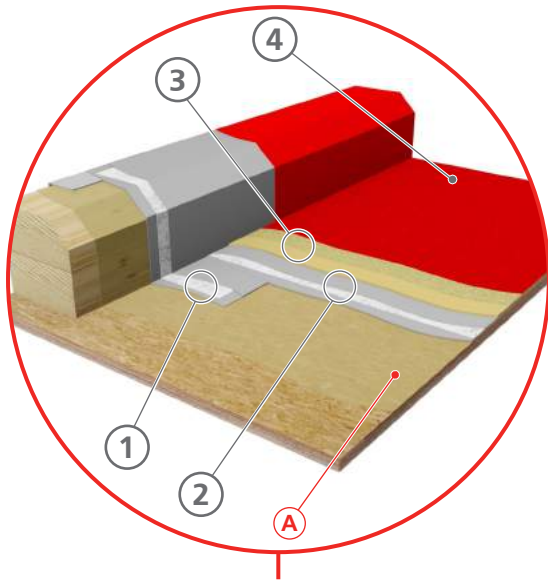

Steps and Stairs

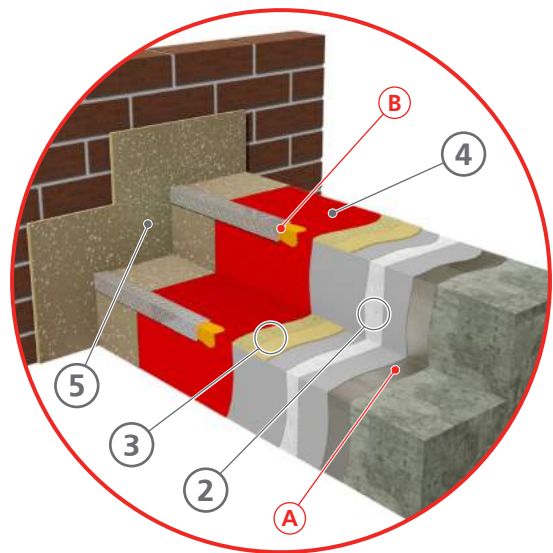

	Membrane		Weight	Size	Surface Finish
①	Detailing (IKO Polimar FCS Detailing; 2x Coats with Detailing Fleece Reinforcement)	IKO Polimar FCS Detailing	10kg (drum)	/	Dark Grey
		IKO Polimar FCS Detailing Fleece, 100gsm	/	0.26x50m roll	White
②	Main Field Waterproofing (IKO Polimar FCS Waterproofing; 2x Coats with Detailing Fleece Reinforcement)	IKO Polimar FCS Waterproofing or Low Odour Waterproofing	10kg (drum)	/	Dark Grey
		IKO Polimar FCS Reinforcement Fleece, 100gsm	100gsm (box)	1.05x50m roll	White
③	Wear Course	IKO Polimar FCS Wear Course (3 x components system)	33Kg (kit)	/	Grey
		IKO Polimar Quartz Sand	25kg (bag)		
④	Top Coat	IKO Polimar FCS Sealer Coat	10Kg (drum)	/	Light Grey, Mid Grey, Dark Grey
⑤	Detailing - Steps & Stairs	IKO Polimar FCS Detailing	10kg (drum)		Dark Grey
		IKO Polimar FCS Detailing Fleece, 100gsm	/	0.26x50m roll	White
		IKO Polimar FCS Deco Chips	1kg (tub)	/	Light Grey, Mid Grey, Dark Grey

Complementary Products

Ⓐ	Primer	Specified IKO Polimar FCS Primer	Page 117
Ⓑ	Stair Nosing	Protective Stair Nosing	/

Additional Information



Sealer Coat Standard Colours *

Light Grey	Mid Grey	Dark Grey

Certificates & Accreditations

Fire Performance	EXT.FAA rating in accordance with BS 476-3
BBA	Agrément Certificate 14/5178

*The printed colours are as accurate as possible, but are for guidance purpose only. RAL reference numbers represent the nearest colours and are not exact matches to all. IKO Polimar coatings. Its surface can be finished in any BS 4800 or RAL colours on request





pitched roofing

Composite Tile System	59
Light Steel Sheeting System	63
Underslating Membranes	68
Complementary Products	72



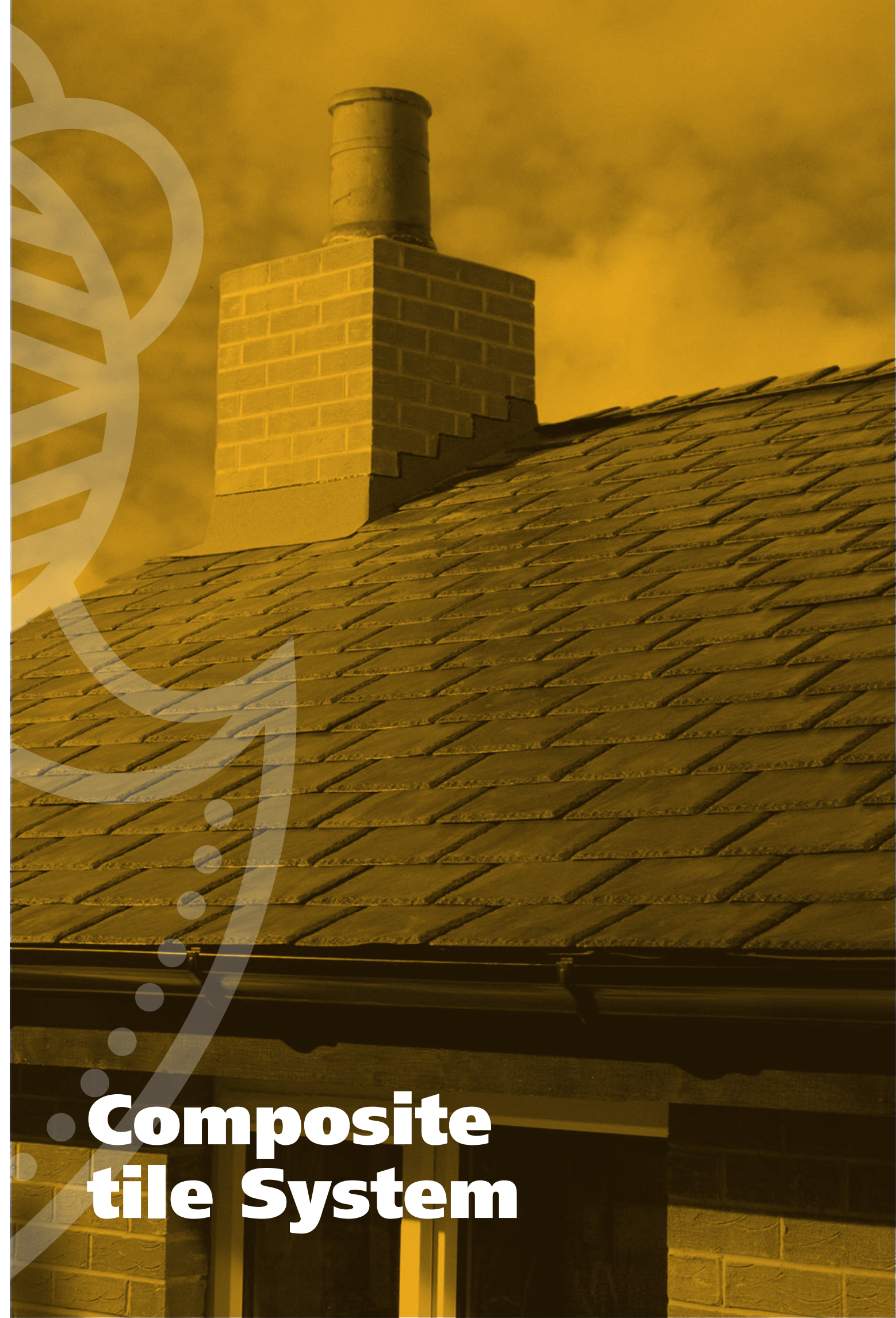

Composite tile System



Recycled, Low Waste Roof Slate

IKOslate is a composite roof tile manufactured from mineral reinforced, 99% recycled and re-engineered materials.

IKOslate has the same aesthetic qualities as slate because moulds of quarried slates are used to form the composite tiles. Each mould imparts different textures and patterns to the tile and its natural look is enhanced by a realistic "slate grey" finish.

IKOslate allows the experienced roofer, or contractor without extensive roofing experience, to deliver a sustainable roof with the look and feel of slate, faster and more economically than previously possible. An IKOslate tile is around 80% lighter than a traditional slate of the same size which makes transporting them to, and around site much easier, especially as they're supplied in clever carry-packs for efficient manual handling.



System Benefits

- Manufactured from 99% recycled, re-engineered materials
- Easy to carry packs with handle
- Quick to install - save time & money on site
- Approximately 80% lighter than natural slate
- Certified to withstand wind and wind driven rain in excess of 110mph
- Resistant to fungicidal and microbial growth as well as airborne chemicals and pollutants
- Robust and non-brittle - less breakages and wastage
- Safe to cut and use on site - no harmful dust created

IKOslate Composite Roof Tile System

Unlike natural slate, tiles can be nailed down using a hammer or nail gun and they can be cut with a hacksaw or jigsaw. Any offcuts are 100% recyclable.

IKOslate Crown Ridge pieces have the texture and finish of regular IKOslate and a flexible hinge which allows them to be easily formed to any ridge profile.

IKOslate is suitable for installation on felt-and-batten roofs with pitches from 22.5° and can be installed on fully boarded roofs down to 18°.

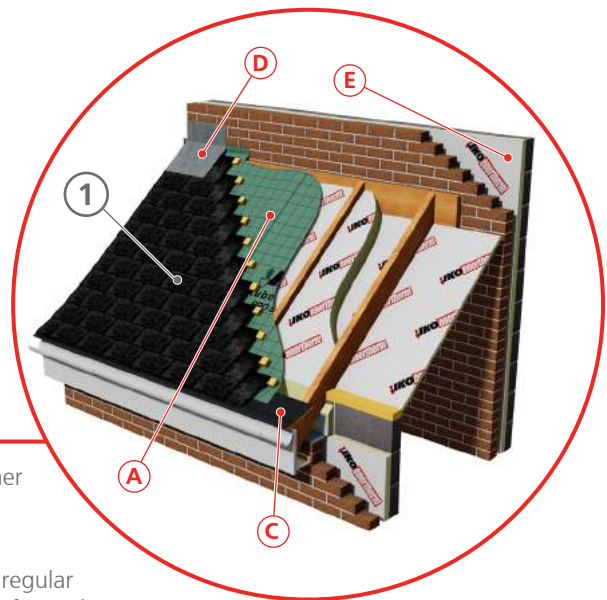

	Membrane	Description	Coverage / Pack	Weight per slate	Slate Size	Thickness	Pack	Colours
①	Composite Tile	IKOslate Roof Tiles	1.5m ²	0.57kg	425.45mm x 285.75mm	7.0mm	27	Slate Grey
②	Crown Ridge Tile	IKOslate Crown Ridge Pieces (not shown on the build up)	3m (linear)	0.45kg	425.45mm x 285.75mm	6.4mm	20	Slate Grey

IKOslate is a brilliant product, second to none when it comes to schools or buildings with accessible roofs. The IKOslate roofing tiles are much lighter than traditional slates, easier to handle and there's less waste.

Martin Richards - JDK Roofing

Complementary Products			
(A)	Underlay	IKO Rubershield Breather Membranes	Page 71
(B)	Ventilation Strip	IKO Armourvent Ventilation Strip for Pitched Roof Ridges (not shown on the build-up)	Page 73
(C)	Protection Strip	IKO Eaves Protection Strip	Page 73
(D)	Flashing	IKOflash Lead-Free Flashing	Page 115
(E)	Insulation	IKO enertherm ALU; high-performance PIR insulation board	Page 92

Additional Information



Colour Options	Certificates & Accreditations	
 Slate Grey	Wind uplift Resistance	Certified to withstand wind and wind driven rain in excess of 110mph FBC 2004/High Velocity Hurricane Zones TAS No.100-95 (175kph)
	Chemical Resistance	Resistant to fungicidal and microbial growth as well as airborne chemicals and pollutants
	UV Resistance	Passed 4,500 hours accelerated arc xenon test for colour fastness and UV resistance





**Light steel
sheeting System**



IKO Metrotile is a roofing system based on lightweight steel tiles. Each profile is pressed from Drawing Quality 3 Steel, the highest grade available in the roofing industry. This has a particularly low carbon level, allowing it to flow freely during manufacture to create a highly durable roof tile with virtually no risk of fracture.

The tiles are galvanised using Aluzinc®, a compound with 55% aluminium and 45% zinc offering unrivalled corrosion resistance. The weather side of each tile is given a base coat primer, to which the coloured stone granules are bonded, and once they're set it's finished with an overglaze to protect the tile and improve insulation.

System Benefits



- Up to 7 times lighter than traditional roofing materials
- Puts less weight and stress on supporting structures and foundations
- More efficient to transport lowering costs and CO₂ emissions
- No more noise than a roof built from traditional materials
- Tested to withstand the most extreme weather conditions
- Can be used on pitches as low as 12°
- 'Dry-Fix' installation is faster, cheaper and produces less waste than a traditional installation
- Needs virtually no maintenance once installed
- 100% recyclable
- Double thickness tiles available for extra security against vandalism

With four different styles in a choice of colours, IKO Metrotile offers a wide range of combinations ideal for any project. Each design reflects the styles of traditional roofing materials to blend in easily with any surroundings.

The Perfect Flat to Pitched Roof Solution



Being up to 7 times lighter than traditional roofing materials, converting an existing flat roof to an IKO Metrotile pitched roof gives you the following benefits:

System Benefits

- Enhance the aesthetic appearance of the building
- Places significantly less stress on supporting structures and foundations
- Provides a low-maintenance solution for the future life of the structure.



IKO Metrotile

Bond 450 & 900

Traditional pantile design
 IKO Metrotile Bond profiles are designed to be aesthetically indistinguishable from traditional clay pantiles, so they offer the same visual appeal with all the additional benefits of lightweight steel roofing.

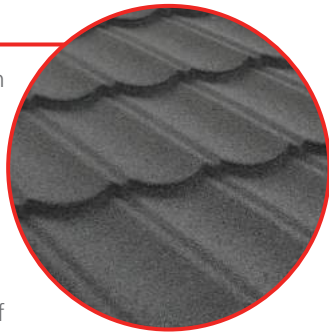

The Bond design is available in six colours and pressed from high grade Aluzinc®* coated steel – standard for all IKO Metrotile profiles.

In addition to the traditional granulated finish, elegant Matt Brown and Gloss Black finishes with a non-toxic powder coating are available.

When dry-fixed to the roof, IKO Metrotile profiles are overlapped and fixed using a cross nail method for excellent durability, protection and resistance to vandalism and wind lift. Each tile is the equivalent of eight conventional roof tiles and can be fixed from vertical right down to a 12° pitch.

Slate

The IKO Metrotile Slate profile offers incredible value and superior performance to traditional slate roof products. The deep lines pressed into each Aluzinc®* coated steel profile gives increased shadow definition, resulting in a tile that looks virtually indistinguishable from traditional slate, while offering unmatched vandal and weather resistance.

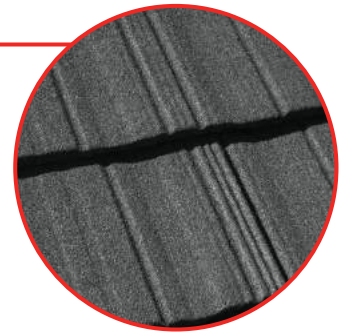

Available in .900mm thickness and formed from high quality Drawing Grade 3 steel, IKO Metrotile Slate is an excellent choice for a wide variety of roofing projects.

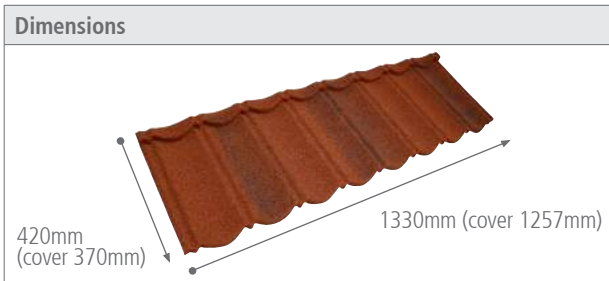

Thickness**	
.450mm	Suitable for most roofing applications
.900mm	For extra resistance to foot traffic or vandalism

Thickness **	
.900mm	For extra resistance to foot traffic or vandalism

*Aluzinc®185 or similar / equivalent protective layer

**Steel thickness according to EN 10346

*Aluzinc®185 or similar / equivalent protective layer

**Steel thickness according to EN 10346

Metrotile Bond 450 & 900 Colours			
Brindle	Bronze	Charcoal	Green
Red	Terracotta	Matt Brown	Gloss Black

Slate Colours		
Brindle	Bronze	Charcoal
Green	Terracotta	

IKO Metrotile

Roman

The elegant double Roman tile is a true design classic and with IKO Metrotile it has all the benefits that lightweight steel roofing systems offer. The beautiful contoured design of each Roman tile complements any roofing project perfectly, with a look that's simultaneously classical and contemporary in style.

Available in five colours pressed in .450mm gauge steel, IKO Metrotile Roman offers the perfect balance of traditional aesthetics and contemporary performance, with virtually zero maintenance and unrivalled protection from vandalism and the elements. Pressed from high quality Drawing Grade 3 Aluzinc®* coated steel and backed by a full selection of matching accessories, IKO Metrotile Roman can be fixed to a pitch as low as 12°.



Shingles

Based on the classic North American timber design, the IKO Metrotile Shingle is a simple and elegant solution for any roof project. It's been designed with a unique 'hidden fix' system that also enables the Shingle to be used as an excellent vertical cladding solution, with the design leaving no nail exposed thus preventing rainwater from corroding the nails – a common weakness of traditional vertical cladding. IKO Metrotile Shingle is available in five colours and can be fixed from vertical down to a minimum pitch of 15°. It's an ideal profile for a simple and elegant roofing or cladding solution.



Dimensions

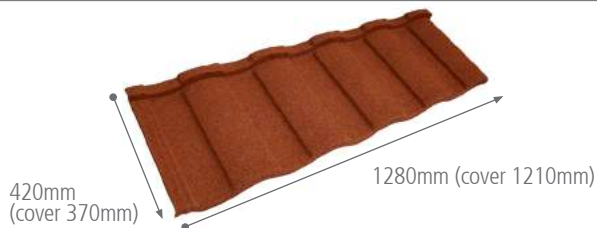

Dimensions



Thickness**

.450mm	Suitable for most roofing applications
.900mm	For extra resistance to foot traffic or vandalism

Thickness**

.450mm	Suitable for most roofing applications
.900mm	For extra resistance to foot traffic or vandalism

*Aluzinc®185 or similar / equivalent protective layer

**Steel thickness according to EN 10346

*Aluzinc®185 or similar / equivalent protective layer

**Steel thickness according to EN 10346

Roman Colours



Bronze Charcoal Green

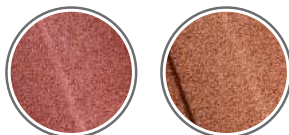

Red Terracotta

Shingles Colours



Antique Red Burnt Umber Charcoal

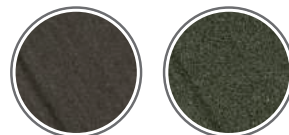

Ebony Moss Green



Additional Information



IKO Metrotile Accessories

IKO supplies a full range of bespoke accessories that fully integrate with our lightweight steel roofing systems. Each product is manufactured to the same high standards as our tile profiles. The full brochure with accessories is available to download from our website.

Installation

Installation of the IKO Metrotile Steel Roofing System is a swift, economical and ecological process thanks to the product's lightweight design and use of modern construction materials. A detailed step-by-step installation guide, together with good site practice and specific information for each IKO Metrotile profile is available from IKO's website.



All additional information available to view and download from our website
www.ikogroup.co.uk/systems-new/roofing-merchant/pitched-roofing/iko-metrotile/



underslating membranes

Underslating Membranes



IKO produces a wide range of underslating membranes to be installed below tile and slate systems providing a secondary barrier against the elements. A tried and tested solution, the bitumen reinforced membrane remains a popular choice for underslating in the UK.

Used within the ventilated cold roof systems as the secondary barrier to the elements. These systems are still compliant today, with IKO still producing IKO Underslating Membranes, formerly known as 1F, to service these traditional approaches.

Underslating membranes are installed below tiles, slates or metal roofing, to provide a secondary barrier against wind driven rain, snow and dust.

IKO Rubershield Range

This range consists of modern breather membranes and system components suited specifically to unventilated roof constructions. Allowing the roof to breathe, they negate the need to provide traditional ventilation to the roof space whilst maintaining that all important role of a secondary barrier to the elements.

System Selector



IKO Underslating Membranes	Product Type	Warm Pitched	Cold Pitched (unventilated)*	Cold Pitched (ventilated)	Timber Framed Wall Application	Eaves Protection (dressing into external gutter)	Page
IKO Rubershield PRO EXTRA	Breather Membrane	●	●	●	●		Page 71
IKO Rubershield PRO	Breather Membrane	●	●	●	●		Page 71
IKO Rubershield ECO EXTRA	Breather Membrane	●	●	●	●		Page 71
IKO Rubershield ECO	Breather Membrane	●	●	●	●		Page 71
IKO Pitched Roof Underlay	Non-Breather Membrane			●			Page 72
IKO Undertile Felt	Bituminous			●			Page 72
IKO Eaves Protections Strip	Bituminous					●	Page 73

* For NHBC project, additional ridge ventilation will be required.



Geographical Wind Zone Table

Applicability of IKO Rubershield & IKO 1F underlays according to BS5534:2014 clause A.8

The BBA Approved (cert No. 15/5190)* IKO Underslating Membrane range meets with the requirements of BS5534:2014 in providing classification of their underlays in respect of performance against published geographical wind zones and wind uplift test data. Use the table below to select the appropriate product for your project. The wind-zone classification shows which zone each option is suitable for, and the maximum batten spacings.

Underlay Type	Wind Uplift Pressure (Pa)				Supported Application**
	Battened Lap / Batten Gauge		Taped Lap* / Batten Gauge		
	345mm	250mm	345mm	250mm	
IKO Rubershield ECO	None	Zones 1 to 3	Zones 1 to 4	Zones 1 to 5	Zones 1 to 5
IKO Rubershield ECO EXTRA	None	Zones 1 to 4	Zones 1 to 5	Zones 1 to 5	Zones 1 to 5
IKO Rubershield PRO	Zone 1	Zones 1 to 5	Zones 1 to 5	Zones 1 to 5	Zones 1 to 5
IKO Rubershield PRO EXTRA	Zones 1 to 2	Zones 1 to 5	Zones 1 to 5	Zones 1 to 5	Zones 1 to 5
IKO IF Undertile Felt	Zones 1 to 5	Zones 1 to 5			

*Laps were taped using Jointing Tape, BRE Report 302-776 Issue 5, 19th March 2015; The use of taped products is currently outside the scope of BBA Certificate 15/5190.

Zone suitability applies only for underlays in applications where a well-sealed ceiling is present, ridge height is not greater than 15m, roof pitch is between 12.5° and 70°, site altitude is not greater than 100m, and no significant site topography is present. Other applications might require underlays with greater wind uplift resistance and is advisable to seek professional advice.

**As specified within BS5534:2014, membranes tested to Zone 1 at equal to or less than 250mm Batten Gauge are suitable for use in all wind Zones at any Batten Gauge when fully supported by a normally tight sheet sarking board i.e. plywood, OSB, rigid insulation board.

Geographical Wind Zone Table

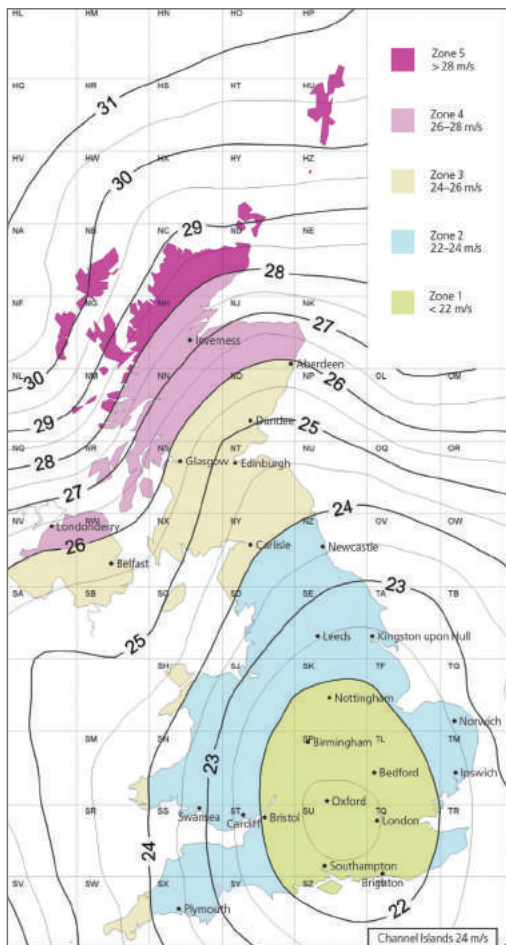

© IHS, reproduced with permission from BRE DG 489, 2014 edition.



Pitched Roof Breather Membrane

IKO Rubershield is a breather membrane, which conforms to BS 5534: 2014 and has BBA certification (cert No.15/5190)* to support its use within a fully supported or unsupported tiled or slated roofing systems. The high vapour permeability and weather resistant nature of this triple-layer engineered fabric provides a permanent quality underlay.

A triple layer highly breathable weatherproof membrane, made from high tensile super-bonded polypropylene layers around a microporous polypropylene film, bonded by ultrasonic lamination. The outer layer forms the functional weatherproof surface, the middle layer is the breathable waterproof membrane, and the inner layer protects the membrane from abrasion and damage, also giving additional strength. This enables the fabric to allow moisture vapour to pass through, whilst providing high levels of secondary protection.



Product Benefits

IKO Rubershield is suitable and certified for use in all tiled and slated pitched roof construction.

- Highly breathable so allows the escape of harmful moisture vapour
- Robust
- Weather resistant
- Long-term durability
- Ideal for warm or cold roof applications (ventilated / unventilated)
- BBA Agrément Certificate 15/5190* for all roof configurations
- Compliant with BS 5534: 2014

Membrane	Roll Weight	Roll Size	Thickness	Tensile Strength (MX / XD)	Tear Resistance (MX / XD)
IKO Rubershield ECO	1m - 5kg 1.5m - 7.5kg	50x1m 50x1.5m	0.35mm	Min 180 N/5cm / min 90 N/5cm	Min 70 N / min 60 N
IKO Rubershield ECO EXTRA	1m - 6kg 1.5m - 9kg	50x1m 50x1.5m	0.43mm	Min 200 N/5cm / min 110 N/5cm	Min 80 N / min 70 N
IKO Rubershield PRO	1m - 7kg 1.5m - 10.5kg	50x1m 50x1.5m	0.48mm	Min 240 N/5cm / min 150 N/5cm	Min 100 N / min 80 N
IKO Rubershield PRO EXTRA	1m - 8kg 1.5m - 12kg	50x1m 50x1.5m	0.50mm	Min 260 N/5cm / min 200 N/5cm	Min 100 N / min 90 N

Additional Information



IKO Rubershield Jointing Tape - Complimentary Product

	A high-performance long lasting double-sided Self-Adhesive tape, protected by a silicon release film on both sides, it is applied between the overlap and at perimeter details/roof penetration points in IKO Rubershield and other polypropylene membranes to effectively seal, joints and detail work, improving waterproofing performance and the airtightness of the installation.	Roll Dimension	No. Rolls per Box
		50mmx50m	12

Complementary Non-Beather Membranes



IKO Systems Underlay Layer

IKO Pitched Roof Underlay is a lightweight high performance underlay for pitched tiled and slated roofs, ventilated in accordance with BS 5534: 2014. Installed in the same manner as conventional tile and slate underlays, IKO Pitched Roof Underlay prevents the ingress of wind-driven dust, rain and snow into the roof void.

Product Benefits

- Clean and easy to handle
- High tensile and tear strength
- Durable
- For use in ventilated cold roofs
- UV resistant
- Convenient roll lengths; 45m and 15m options
- Conforms to BS 5534: 2014



Membrane	Roll Dimensions	Weight	Mass per unit area
IKO Pitched Roof Underlay	1x45m	6.3kg	140gsm
	1x15m	2.1kg	

IKO 1F Undertile Felt (Formerly BS747 Type 1F)

IKO Undertile Felt is the traditional underslating, complying to British Standards and still favoured by many roofers. IKO Undertile reinforced slaters' felt is manufactured specifically for use as an underslating beneath tiles or slates. It can also be used as a vapour retarder in built-up roofing.

IKO Undertile Felt has a felt fibre base combined with a layer of open weave hessian, saturated and coated with bitumen and surfaced with sand.

Product Benefits

- Long established and highly regarded slaters' felt
- Suitable for cold ventilated roofs
- UK manufactured
- To be used with IKO Eaves Protection Strip

Membrane	Roll Dimensions	Weight
IKO 1F Undertile Felt	1x15m	22.5kg



Complementary Product



IKO Eaves Protection Strip

In conjunction with the underslating membrane, IKO Eaves Protection Strip should be used to give lasting protection where the underslating dresses into external gutters. It should be used with any underslating material (including breather membranes), any tile or slate finish and in cold or warm roof configurations. The IKO Eaves Protection Strip is a specially cut 500mm or 330mm width of high-performance polyester based roofing (BS 747 Type 5U).

Product Benefits

- Provides eaves protection
- Conforms to NHBC technical standards
- Ensures full protection when dressing into an external half round guttering
- Suitable for use with any tile or slate



Membrane	Roll Dimensions	Weight	Finish
IKO Eaves Protection Strip	16x0.33m	4.79kg	Sand Surfaced
	16x0.5m	7.25kg	

IKO Armourvent Ventilation Strip

A ventilation system that provide you with a fabulous roof without visible appliances. The unique design consists of a thin but ultra-strong profile ensuring a smooth, straight and virtually invisible roofline.

Product Benefits

- Effective but discreet ventilation solution
- Helps control condensation in the roof void
- Strong and durable _ helps extend the life of the roof
- Rigorously tested in extreme weather conditions



Membrane	Roll Dimensions	Weight	Thickness
IKO Armourvent Ventilation Strip	6x0.228m	3.4kg	15mm





industrial sheeting & cladding

Cold Applied Liquid for Pitched Metal Roofs	77
Cold Applied Liquid for Cladding & Sheeting	81



IKO Polimar Pitched Metal Roof Systems

IKO Polimar is a high-performance range of liquid waterproofing systems. Regardless of application, IKO Polimar systems are extremely versatile, completely cold applied and can be specified to match the longevity of your project through a range of build-up options.

IKO Polimar liquid applied technology has been specifically developed to deliver exceptional waterproofing for flat or metal profile roofs. It is part of IKO's cold applied portfolio.

Cold applied systems meet the demand for systems minimising risks associated with hot works.

System Benefits

- Rapid, clean, safe and sustainable
- Seamless installation
- No hot bitumen/gas bottles on site
- Reduced insurance premiums



IKO polimar[®] EC/UV

Liquid Applied Waterproofing



The IKO Polimar EC/UV system is a high-performance polyurethane resins that is extremely durable and puncture resistant. The manageable pack size of the products is ideal for areas of limited access.



System Benefits

- Premium performance
- Excellent durability and puncture resistance
- Highly flexible in its design application
- Wet-on-wet EC application saves time
- For new construction or refurbishment projects
- Suits most roof types
- Applicable for full overlay installations
- Can be applied to existing sound substrates
- Simplifies complex detailing
- 15 to 20 year designed solutions

IKO Polimar EC/UV Roofing System

IKO Polimar EC is a high-performance, high-build polyurethane embedment coat. It incorporates moisture triggered curing technology that forms the base layer of the IKO Polimar EC/UV system. With excellent fluid properties for ease of application, this provides a cost effective, high solids coat that offers superb adhesion. IKO Polimar EC can be applied to a wide range of substrates and facilitates excellent detailing in complex areas.

IKO Polimar UV is an elastomeric, high-build single component polyurethane UV stable top coat which comprises a blend of moisture triggered polyurethane resins. Once applied, the cured membrane forms a seamless durable waterproof barrier which provides excellent thermal and UV stability for all climatic conditions. Isolated reinforcement is applied to all panelled joints and abutments, using the IKO Polimar (Glass Reinforcement Fleece) GRF and IKOpro (Bridging Tape) BT products.

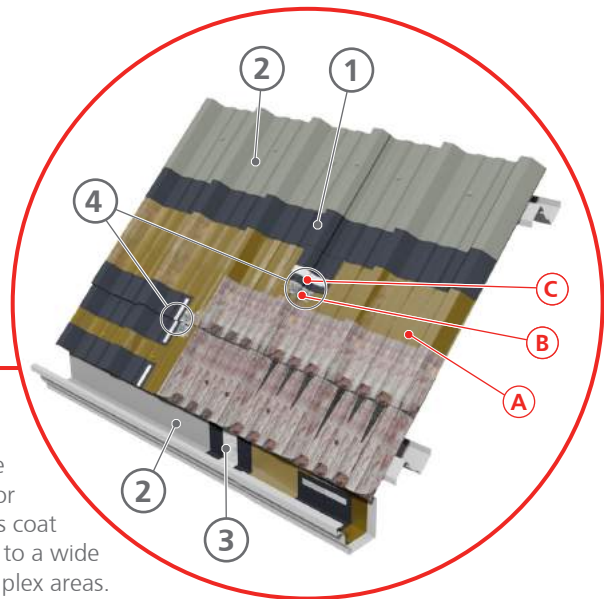

	Membrane	Description	Weight	Size	Coverage Rate	Surface Finish
①	Embedment Coat	15 Year IKO Polimar EC	12.5ltr (drum)	/	1.2ltr/m ²	Black
		20 Year IKO Polimar EC	12.5ltr (drum)	/	2.0ltr/m ² wet on wet	Black
②	Top Coat	IKO Polimar UV	10kg (drum)	/	0.5ltr/m ²	Mid Grey, Dark Grey, Copper Green, White
③	IKO Polimar EC Embedment Coat with IKO Polimar GRF (225gsm) to all details					
④	IKOpro Bridging Tape followed by IKO Polimar GRF fully embedded in IKO Polimar EC Embedment Coat to all panel joints					

Notes:

Primers: Primers are not normally required but metal, porous surfaces and other specific substrates may require priming. Adhesion test may be required on certain surfaces. IKO Polimar GP Primer is recommended on rough substrates. See IKO Polimar Primers Page 121.

Waterproofing: The coverage rates quoted are typical values for the type of surface indicated – more material will be required where the surface condition of the substrate is variable - Full embedment of the glass reinforcement fleece (GRF) must be achieved in all cases.

Reinforcement: All flat roofs must be fully reinforced with IKO Polimar GRF. Additional localised reinforcement using IKO Polimar (Knitted Reinforcement Mat) KRM, (fully saturated in IKO Polimar EC) and IKOpro BT will be required over joints and other areas where movement may be expected. See IKO Polimar Accessories Page 123.

Top coats: The coverage rates quoted are the minimum required for each system.

Complementary Products			
Ⓐ	Primer	IKO Polimar MC & IKO Polimar GP Primers	Page 121
Ⓑ	Bridging Tape	IKOpro Bridging Tape	Page 123
Ⓒ	Reinforcement	IKO Polimar GRF	Page 123

Additional Information



Top Coat Standard Colours *			
Mid Grey	Dark Grey	Copper Green	White*

Certificates & Accreditations	
Fire Performance	EXT.FAA rating in accordance with BS 476-3
NHBC	Accepted

*The printed colours are as accurate as possible, but are for guidance purpose only. RAL reference numbers represent the nearest colours and are not exact matches to all IKO Polimar coatings.





IKO Polimar (Cladding Reinforcement System) CRS is a single component refurbishment system for the rejuvenation of external plastisol coated metal sheeting and cladding areas. This includes plastisol, one of the most common forms of external cladding used on industrial, commercial and leisure buildings.



System Benefits

- For areas of external cladding
- Durable and highly flexible
- Choice of colours
- Water vapour permeable
- Complex shapes easily incorporated
- Does not chalk on ageing

IKO Polimar CRS Sheeting & Cladding Refurbishment System

IKO Polimar CRS is a solvent based, moisture cured flexible polyurethane coating based on a unique blend of aliphatic resins reinforced with colour stable and chemical resistant pigments.

IKO Polimar CRS has been developed to provide a tough, durable finish with excellent erosion, weather and UV resistance.

When installed by an IKO approved contractor this material will give a design life of 10 years, dramatically reducing external exposure degradation, chalking or deterioration of adhesion.

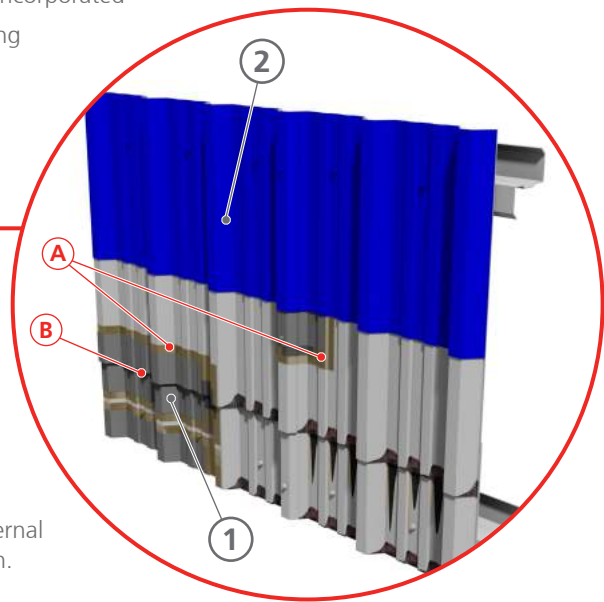

	Membrane	Description	Weight	Coverage Rate	Surface Finish
①	Seal	IKO Polimar CRS Seal	5ltr	1.2ltr/m ²	Grey
②	Coating	IKO Polimar CRS Finish	10ltr (drum)	6.7ltr/m ²	In a range of colours

Notes:

Primers - Primers are not normally required on sound plastisol surfaces. Exposed metal must be suitably prepared and primed with IKO Polimar AP. See IKO Polimar primers Page 117.

Coatings - Two coat system (some applications with no colour change may require only one coat).

Complementary Products			
Ⓐ	Primer	IKO Polimar CRS Primer	Page 121
Ⓑ	Tape	IKO Polimar CRS Tape	Page 123

Additional Information



Certificates & Accreditations	
Fire Performance	EXT.F.AA rating in accordance with BS 476-3
NHBC	Accepted

Total System Protection



This comprehensive range of high-performance IKO Polimar CRS products and ancillaries will enhance and protect the external plastic coated metal sheeting and cladding area of your roof, wall and GRP rooflights.

IKO Polimar CRS for enhanced protection and aesthetics

Refurbish, rejuvenate and protect (enhance the aesthetics of your building and protect by re-waterproofing your roof).

IKO Polimar CRS for effective repairs

Many old steel roofs suffer badly from weather corrosion, which usually begins at the end laps where edges can peel. IKO Polimar CRS can be used as a cost effective and reliable solution to treat end-lap and overlap corrosion problems.

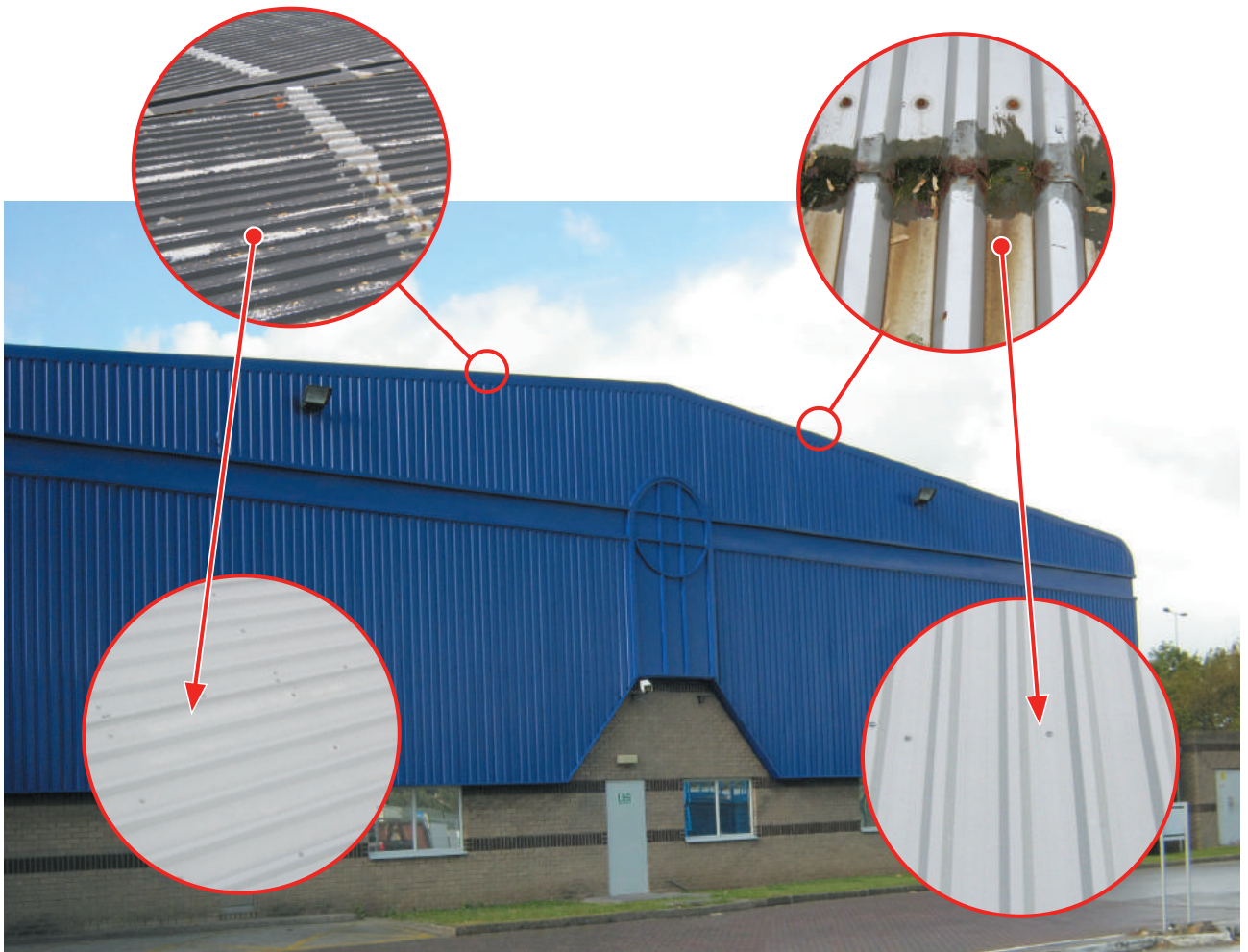

car park system

Cold Applied Liquid for Car Parks

85



CAR PARK SYSTEM

IKO Polimar FCS Car Park System

IKO Polimar is a high-performance range of liquid waterproofing systems. Regardless of application, IKO Polimar systems are extremely versatile, completely cold-applied and can be specified to match the longevity of your project through a range of build up options.

IKO Polimar Fast Curing System (FCS) offers specifiers and installers the benefit of rapid curing with enhanced efficiency on site. IKO Polimar FCS has been developed to provide a fast curing solution for car parks applications and BBA Approved (certificate no. 14/5178).

System Benefits

- Rapid, clean, safe and sustainable
- Seamless installation
- No hot bitumen/gas bottles on site
- Reduced insurance premiums

IKO Polimar is just one of a comprehensive range of waterproofing systems from IKO, enabling the specifier or contractor to be guided through the process of selecting the most suitable waterproofing option for each project.





IKO Polimar (Fat Curing System) FCS Car Park Waterproofing System is a fast-curing, highly-durable and flexible, slip-resistant waterproofing coating capable of withstanding mechanical stresses.

This innovative system is a seamless, minor crack-bridging and joint-bridging waterproofing system that is able to withstand typical mechanical stresses. It contains a highly flexible fleece-reinforced waterproofing layer as well as abrasion-resistant system layers for vehicle and foot traffic. The waterproofing systems liquid application and high-bonding strength on almost any substrate also allows breakthroughs and upstands to be integrated securely and seamlessly. These properties make the system a cost-effective solution for car parks, especially for refurbishment projects.

IKO Polimar FCS layers cure in 20 to 30 minutes, and the system is trafficable after 45 minutes.

System Benefits

- Heavy-duty wearing layer for vehicle and foot traffic
- Fully bonded to the substrate, therefore no flow paths for water
- Liquid application ensures seamless incorporation and secure waterproofing of the most complex upstands
- Permanently flexible and crack-bridging even at extreme sub-zero temperatures
- Permanently weather-resistant (resistant to high and low temperatures, UV rays, hydrolysis)
- Resistant to most commonly used acids and alkali solutions



IKO Polimar FCS Car Park Waterproofing System

IKO Polimar FCS Car Park Waterproofing System consists of a primer, a waterproofing layer, a reinforcement fleece, a 3mm self-levelling wear course with a hard wearing slip resistant aggregate, a sealing coat and a heavy-duty abrasion-resistant and skid resistant wearing layer suitable for vehicle traffic.

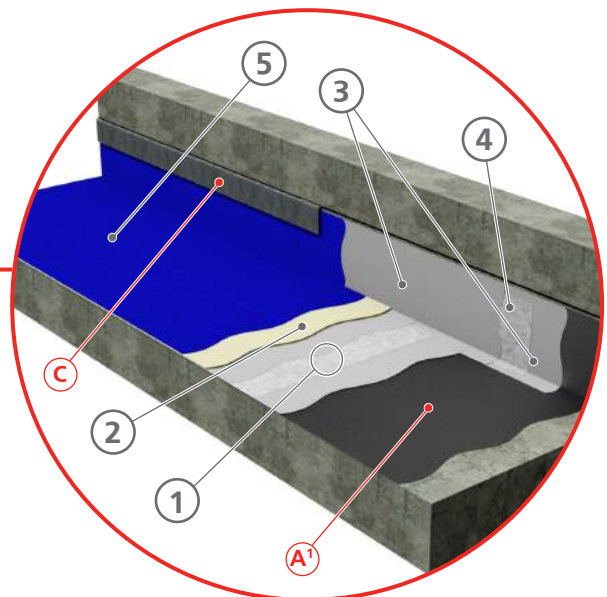

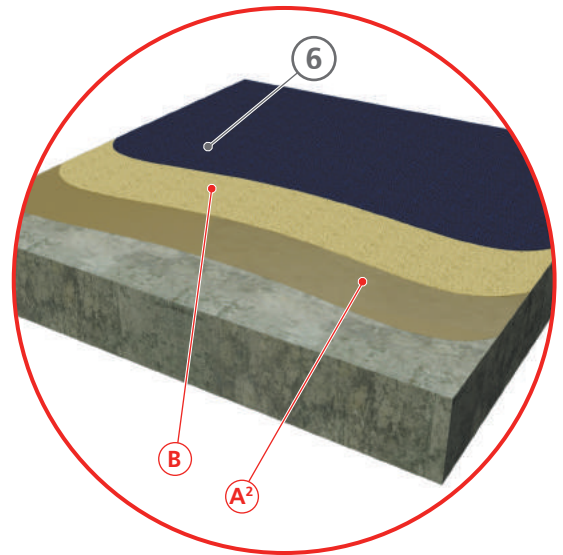

IKO Polimar FCS Car Park Intermediate Deck (Optional)



	Membrane	Description	Weight	Size	Coverage Rate	Surface Finish
①	Main Field Waterproofing (IKO Polimar FCS Waterproofing; 2x Coats with Reinforcement Fleece)	IKO Polimar FCS Waterproofing or IKO Polimar FCS Low Odour Waterproofing	10kg (drum)	/	Substrate Type: - Smooth: 2.5kg/m ² - Fine grained: 3kg/m ² - Rough: 3.5kg/m ²	Dark Grey
		IKO Polimar FCS Reinforcement Fleece	100gsm (roll)	1.05x50m	/	White
②	Wear Course	IKO Polimar FCS Wear Course	33kg kit (10kg drum & 23kg bag)	/	4kg/m ²	Grey
③	Detailing	IKO Polimar FCS Detailing	10kg (drum)	/	2.5kg/m ²	Dark Grey
④	Detailing Reinforcement	IKO Polimar FCS Detailing Fleece	100gsm (roll)	1.26x50m	/	White
⑤	Surfacing <i>*use on ramps & high-wear areas</i>	IKO Polimar FCS Surfacing	15kg (drum)	/	2.2kg/m ²	Bespoke
		IKO Polimar FCS Heavy Duty Surfacing	15kg (drum)	/	3.5kg/m ²	Bespoke
⑥	Top Coat	IKO Polimar FCS Sealer Coat*	10Kg (drum)	0.5Kg/m ²	/	Light Grey, Mid Grey, Dark Grey

Note: Suitability of the substrate needs to be verified by IKO Technical Services prior to application.

Complementary Products			
Ⓐ	Primer	A ¹ - IKO Polimar FCS Low Viscosity Primers	Page 117
		A ² - IKO Polimar FCS Primer	Page 117
Ⓑ	Mineral Finish	IKO Polimar FCS Quartz Aggregate	Page 120
Ⓒ	Flashing	IKOflash Lead-Free Flashing	Page 115

Additional Information



Top Coat Standard Colours *		
		
Light Grey	Mid Grey	Dark Grey

Certificates & Accreditations	
Fire Performance	EXT.FAA rating in accordance with BS 476-3
BBA	Agrément Certificate 14/5178
NHBC	Accepted

*IKO Polimar FCS Sealer Coat is available in three standard colours which are light grey, medium grey and dark grey. The printed colours are as accurate as possible, but are for guidance purpose only. Its surface can be finished in any BS 4800 or RAL colours on special order.



insulation

Insulation for Flat Roofs & Inverted Roofs,
Balconies & Walkways

91





Modern buildings are designed to do more than just protect the occupants from the elements. They also need to keep them at a comfortable temperature, maximising energy used for heating and minimising the impact on the environment.

The same goes for roofing. This is why IKO are a global player in insulation, producing a range of options suitable for every type of flat roof system; reinforced bitumen membranes, mastic asphalt, hot melt and single ply - whatever the specification, the IKO range of insulation products can match it. But more importantly, our insulation also matches whatever thermal performance you need to meet ever-more stringent regulations.

IKO Systems	Product Type	Roof Type	Membrane Application	Thermal Conductivity	Compressive Strength	Page
IKO enertherm ALU	PIR	Flat Roof	Self-Adhesive reinforced bituminous membranes	0.022	175	92
IKO enertherm BGF	PIR	Flat Roof	Torch-applied reinforced bituminous membranes	0.026	150	93
IKO enertherm MG	PIR	Flat Roof	Adhered reinforced bituminous membranes	0.026	150	93
IKO enertherm XPS	XPS	Inverted Roof	/	0.033	300	94
IKO enertherm VIP	VIP	*Inverted Roof, Balcony & Walkway	/	0.008	160	95

*Where the lack of construction depth or space is an issue

All IKO Insulation Boards can be used over a suitable IKO Vapour Control Layer on substrates such as profiled metal decking, timber panels, screeded concrete, or in accordance with any IKO roofing specification.





IKO enertherm, high performance insulation systems

IKO insulation boards are made from lightweight, fire resistant, 100% CFC, HCFC or HFC-free insulation board with a rigid polyisocyanurate (PIR) foam core.

IKO enertherm has an exceptionally fine cell structure, Micro Cell Technology (MCT) which gives it unique characteristics.

The highly efficient closed cell structure has a low thermal conductivity and easily achieves required U-values with a minimum thickness, high compressive strength and dimensional stability.

Zero global warming and zero ozone depletion potential.

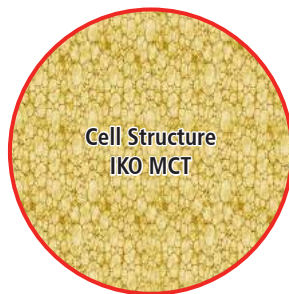
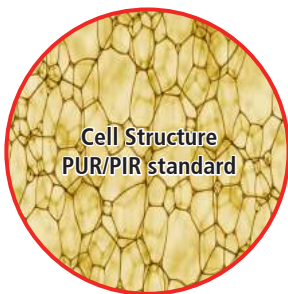

System Benefits

- Agrément Certificate 15/5283
- Fire performance polyisocyanurate foam core
- Mineral glass or composite aluminium facings available
- Lightweight and easy to handle
- Less volume for the same high insulation value/low thermal conductivity
- Fit for walking on during the work and after
- Rot proof, durable and maintenance-free
- Ideal for meeting increasingly demanding Building Regulations and Part L requirements
- Tapered/cut-to-falls boards also available

Insulation Board Edge Finishes		
Straight	Rebate (SP)	Tongue & Groove (TG)

IKO enertherm ALU

IKO enertherm ALU is used for the insulation of flat roofs for new or refurbishment projects on concrete, steel deck and timber substrates.

Designed for self-adhesive reinforced bituminous membranes.

Both sides of the insulation board are clad with a multi-layer gas-tight aluminium construction. This high-quality reflecting ALU cladding consists of no fewer than seven layers, combined into a single construction. It is tested under extreme conditions regarding water absorption, mechanical properties, corrosion resistance and emissivity.

Details

- Thermal conductivity: thermal conduction coefficient: (EN 13165) λD: 0.022W/(m.K)
- Compressive strength at 10% deformation: ≥ 175 kPa

Thermal Resistance Rd-value (m². K/W)

IKO enertherm ALU (mm)	30	40	50	60	70	80	90	100	110	120	140	160	180	200
1,200 x 600 mm	1.35	1.80	2.25	2.70	3.15	3.60	4.05	4.50	-	5.45	6.35	7.25	8.15	9.05
1,200 x 1,000 mm	1.35	1.80	2.25	2.70	3.15	3.60	4.05	4.50	-	5.45	6.35	-	-	-
2,400 x 1,200 mm	1.35	1.80	2.70	3.15	3.60	4.05	4.50	5.00	5.45	6.35	-	-	-	-

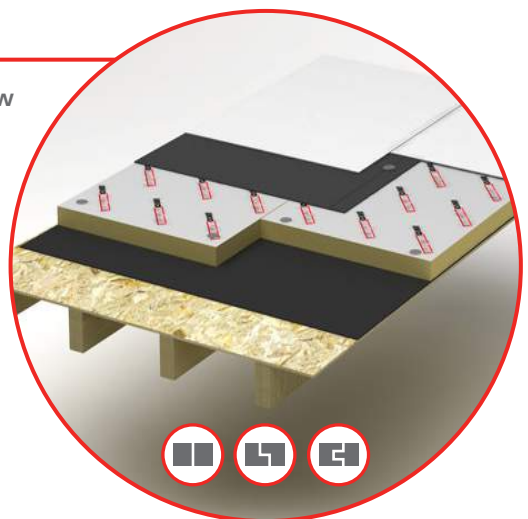

IKO enertherm BGF

IKO enertherm BGF is used for the insulation of flat roofs, preferably in a torched application in combination with bituminous and plastic membranes.

Designed for torch-applied reinforced bituminous membranes.

The PIR foam core is encased with a polypropylene-covered bitumen sand free glass membrane.

Details

- Thermal conductivity: thermal conduction coefficient: (EN 13165)
λD: 0.027W/(m.K) until 120mm and 0.026W/(m.K) from 120mm.
- Compressive strength at 10% deformation: ≥ 150 kPa

Thermal Resistance Rd-value (m². K/W)

IKO enertherm BGF (mm)	81	100	120	140
1,200 x 1,000 mm	3.00	3.70	4.60	5.35

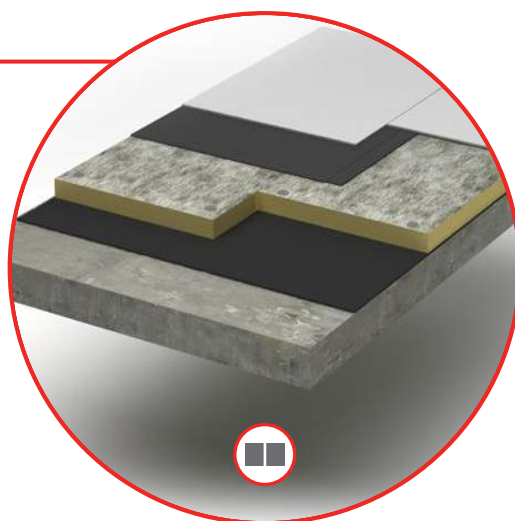

IKO enertherm MG

IKO enertherm MG is used for the insulation of flat roofs in combination with plastic roof covering, also possible in combination with bituminous membranes.

Designed for adhered reinforced bituminous membranes.

Both sides are clad with a perforated coated glass membrane.

Details

- Thermal conductivity: thermal conduction coefficient: (EN 13165)
λD: 0.027W/(m.K) until 120mm and 0.026W/(m.K) from 120mm.
- Compressive strength at 10% deformation: ≥ 150 kPa

Thermal Resistance Rd-value (m². K/W)

IKO enertherm MG (mm)	30	40	50	60	70	81	90	100	120	140
1,200 x 600 mm	1.10	1.45	-	2.20	-	3.00	-	3.70	-	-
1,200 x 1,000 mm	1.10	1.45	1.85	2.20	2.55	3.00	3.30	3.70	4.60	5.35
2,400 x 1,200 mm	-	1.45	1.85	-	2.55	3.00	-	3.70	4.60	-

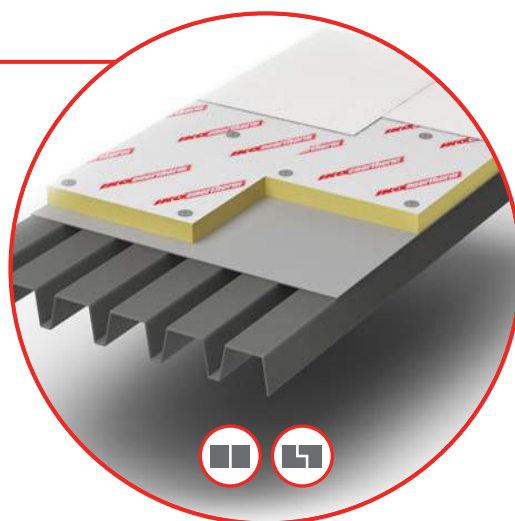

Additional Information



Certificates & Accreditations			
	ALU	BGF	MG
Fire Performance	Fire class according to EN 13501-1: Class E Fire class 'end use' according to 13501-1: B-S,d0 (steel deck)	Fire class according to EN 13501-1: Class F	Fire class according to EN 13501-1: Class E
FM	FM Approved	FM Approved	FM Approved
BBA	Agrément Certificate 15/5283	Agrément Certificate 15/5283	Agrément Certificate 15/5283
CE Marking	In accordance with harmonised European Standards BS EN 13165: 2012	In accordance with harmonised European Standards BS EN 13165: 2012	In accordance with harmonised European Standards BS EN 13165: 2012
Site Certification	ISO 14001		ISO 14001



IKO enertherm XPS

IKO enertherm XPS is a rigid extruded polystyrene (XPS) board; lightweight and lap jointed with high compressive strength. Designed for the thermal insulation of a wide variety of flat roofs including: inverted roof below ballast or paving slabs or in a green/garden roof configuration.

IKO enertherm XPS has a Global Warming Potential (GWP)* of less than 5 and achieves a BRE Certified Green Guide Rating of A.

System Benefits

- 15mm lap joint
- Excellent thermal performance
- High compressive strength
- Highly resistant to water absorption
- Able to resist repeated freeze/thaw cycles
- Lightweight and easy to install
- Tough and durable
- Dimensionally stable

Details

- Declared thermal conductivity: 0.033W/mk
- Comprehensive strength: 300kPa

Thermal Resistance Rd-value (m². K/W)

IKO enertherm XPS (mm)	70	130	160	180	200	220
1,250 X 600mm	2.10	3.90	4.80	5.45	6.05	6.65

* The Global Warming Potential (GWP) was developed to allow comparisons of the global warming impacts of different gases. Specifically, it is a measure of how much energy the emissions of 1 ton of a gas will absorb over a given period of time, relative to the emissions of 1 ton of carbon dioxide (CO₂). The larger the GWP, the more that a given gas warms the Earth compared to CO₂ over that time period.



Additional Information



Certificates & Accreditations	
Fire Performance	EXT.F.AA rating in accordance with BS 476-3: 1958
FM	FM Approved
BBA	Agrément Certificate 14/5149
CE Marking	Accepted
Site Certification	ISO 9001, ISO 14001

IKO enertherm VIP

IKO enertherm VIP is an inverted insulation for balconies and terraces providing optimum insulating performance. Designed for where there is a requirement for both low U-values and the thinnest possible construction build-up.

IKO enertherm VIP is a rigid vacuum insulation panel with microporous core which is evacuated, encased and sealed in a thin, gas-tight envelope, providing outstanding thermal properties, and the thinnest possible solution to insulation problems. The insulated panel comes with a pre-bonded protective layer underneath, offering superior product protection.

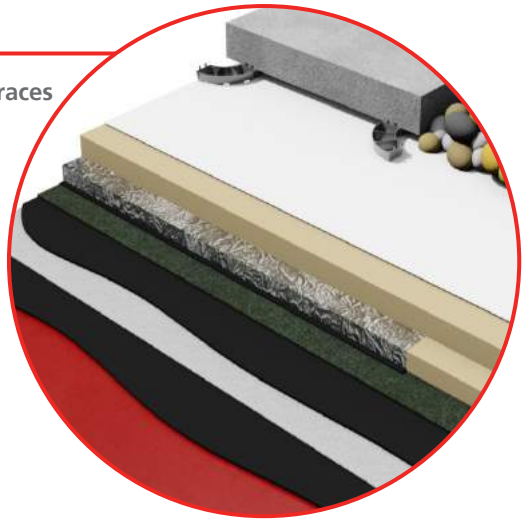

System Benefits

- Rigid vacuum insulation panel for optimum performance (thermal conductivity 0.008 W/m·K)
- Space saver insulation panel
- Superior product protection
- Save on labour. The board comes ready to be installed, with the protection layer pre-bonded underneath.
- Over 90% recyclable (by weight)
- Resistant to the passage of water vapour
- Ideal for new build and refurbishment
- Non-deleterious material
- Bespoke scheme layout drawing for every project

Details

- Thermal conductivity: 0.008 W/m·K
- Compressive strength: 150 kPa

Thermal Resistance Rd-value (m². K/W)

IKO enertherm VIP (mm)	20	25	30	40	50
Length: 300 - 1200mm Width: 300 - 600mm	2.50	3.12	3.75	5.00	6.25



IKO enertherm WCL

IKO enertherm (Water Control Layer) WCL is a high performance, thermally bonded tri-laminate of polypropylene; spun bonded (outer layers) and microporous (inner layer). Designed as a separating and water control layer in low moisture impact inverted and green roofs.

It is used in combination with IKO enertherm XPS as part of the IKO enertherm WCL System for inverted and green roofs.

Water resistant properties result in reducing the flow of water through the roof construction. This means that the impact on thermal performance by rainwater cooling is largely negated.

Inverted and green roofs incorporating IKO enertherm WCL are lighter as less ballast is required. This is due to a vastly reduced floatation impact as more drainage occurs above the insulation than below it.

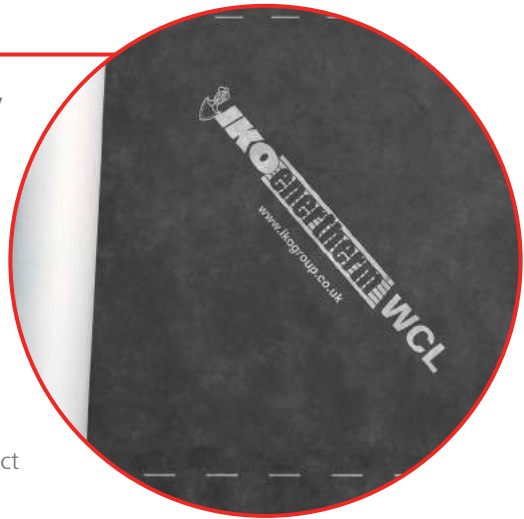

System Benefits

- Improves the thermal performance of inverted and green roofs
- Waterproof and water vapour permeable
- Enables thinner insulation and less ballast to be used

Product Details

Length	Width	Area per Roll
100m	1.5m	150m ²

IKO enertherm Insulated Hard Edge

IKO enertherm Insulated Hard Edge is a stop batten that combines the properties of an incompressible perimeter edge or gutter termination to prevent cold bridging. IKO enertherm Insulated Hard Edge can be used with felt, mastic asphalt, single ply and liquid waterproofing.

IKO enertherm Insulated Hard Edge is factory engineered to precise tolerances, it features a high performance insulating core of rigid PIR foam and (Oriented strand board) OSB faces that allow for the mechanical attachment of drips and perimeter trims. It is lightweight, stable and available in a full range of thickness options to complement detailing with any insulation board.

Sections are lightweight, easy to fix and are available in 1,200mm lengths ordered on a project specific basis. They form part of an extensive range of components including angled kerbs and tapered battens that suit many applications.



Product Benefits

- Factory engineered to precise tolerances
- Available in different heights & thickness
- Easy to fix to a variety of roof decks
- Lightweight & dimensionally stable
- Bonded or mechanically fixed
- Prevents cold bridging
- Easy to handle and transport
- Suitable for fixing drips and trims
- Thermally efficient PIR foam core
- Made using recycled materials

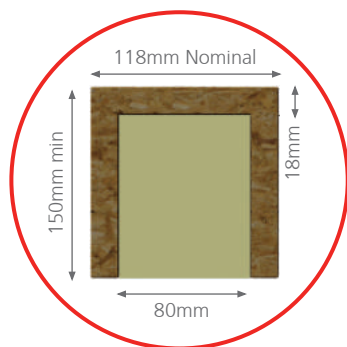
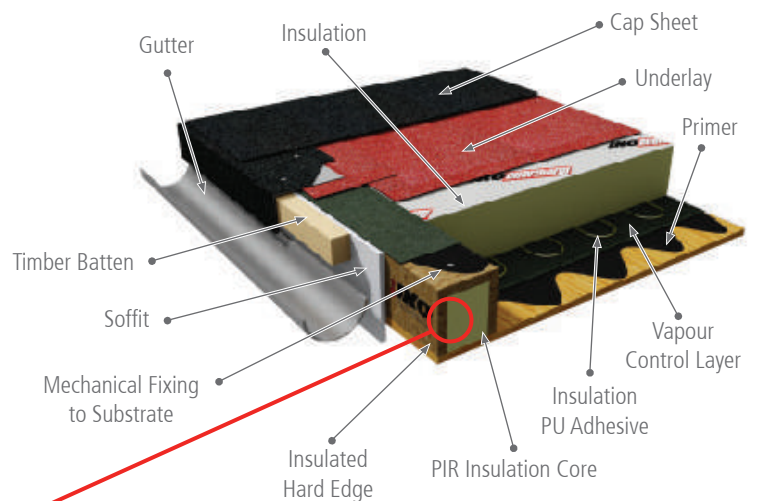



accessories

Primers	101
Adhesives	101
Rooflights	103
Preformed Bituminous Detailing	107
IKOfix Integrated Fixing Point	108
Roof Edge Trims	109
Rain Water Outlets	111
Lightening Conductor Clips	112
Recovery Board	112
Guardrail	113
IKO Demarcation	114
Paving Support Pad	115
Lead-Free Flashing & Sealent	116

annex

Cold Applied Liquids	118
----------------------	-----





Liquids for the Professional



IKOpro Primers for Reinforced Bituminous Membranes

IKOpro Systems Bonding Agent

IKOpro Systems Bonding Agent is a fast drying primer for the adhesion of self-adhesive bitumen roofing membranes.

The solvent based primer, based on synthetic rubber and resins is specially formulated to activate self-adhesive bitumen roofing membranes to promote a strong bond even at low temperatures.

Product Details

Size	Coverage
15ltr	3-5m ² /ltr (approx. 60m ² /tin)



IKOpro Quick Dry Bitumen Primer

Deep penetrating bituminous solution for stabilising dusty porous surfaces prior to the application of IKO roofing systems.

It dries in approximately 30 minutes with no residual tack.

Product Details

Size	Coverage
2.5ltr, 5ltr & 25ltr	Metal 10-15 ² /ltr
	Concrete 3-4 ² /ltr
	Bituminous Roofing (approx) 5 ² /ltr
	Fibre Cement 10-12 ² /ltr



IKOpro High Performance Adhesives



IKOpro Sprayfast MPP (Multi-Purpose Primer)

IKOpro Sprayfast MPP (Multi Purpose Primer) is a specially formulated high performance bonding primer, delivered and applied via the delivery system below. It allows the speed of application of the bonding primer to be 5 times faster than conventional bitumen primers, promoting strong bonds at temperatures as low as 5°C.

Product Benefits

- Multi-purpose – Can be used with IKO Self-Adhesive or IKO Torch-On membranes
- Covers the area quicker than roller applied primers, with increased even coverage



Product	Application	Colour	Container Size	Average Coverage m ² /container*
IKOpro Sprayfast MPP	Bonding Primer	Black	26kg	Up to 150m ² S-A Up to 250m ² T-O

IKOpro High Performance Adhesives



IKOpro Sprayfast IBA (Insulation Bonding Adhesive)

A moisture-curing polyurethane adhesive that can be applied faster and more accurately than standard hand-poured bead-applied PU adhesives. The system enables rapid, professional bonding of a wide range of insulation boards to vapour control layers or straight to a deck.

Product Benefits

- One square metre of insulation board can be covered in as little as 2-3 seconds
- Cures in as little as 15 minutes



IKOpro Sprayfast BMA (Bituminous Membrane Adhesive)

Specifically developed for bonding bituminous roofing membranes to a wide range of insulation boards and other substrates. For a high quality, even finish, its adhesive properties ensure that the membrane can be laid consistently flat while helping to compensate for uneven roof decks.

Product Benefits

- Quick and easy to apply
- High strength bonding solution



IKOpro PU Adhesives

With two variants - for insulation (green) and membrane (red) - this permanently elastic, high performance single part polyurethane adhesive with foaming capacity is ideal for bonding a wide range of rigid insulation boards and high performance bitumen membranes.

Product Benefits

- Moisture curing
- Solvent-free



Product	Application	Colour	Container Size	Average Coverage m ² /container*	Coverage Rates
IKOpro Sprayfast IBA	Insulation	Green	24.5kg	Up to 350m ²	20-40mm bead @250-300mm centres
IKOpro Sprayfast BMA	Membrane	Red	24.5kg	Up to 190m ²	20-40mm bead @250-300mm centres
IKOpro PU Adhesive	Insulation	Green	6.5kg	Up to 35m ²	4-6 beads per m ² @50 to 100g per linear m
IKOpro PU Adhesive	Membrane	Red	6kg	Up to 35m ²	4-6 beads per m ² @50 to 100g per linear m

* Dependent on substrate (for further details please refer to the relevant product datasheet)



IKO Superlite Rooflights

IKO Superlite Modular Rooflights are a range of high quality triple glazed UV-protected thermoformed polycarbonate domes, supported on either PVCu or GRP upstands. The whole unit U-value exceeds the requirements of Approved Document L 2010.

IKO Superlite Rooflights can be supplied in clear, opal diffused, bronze or 'Heat Reflect' (reflecting up to 68% heat radiation) glazing and use a minimum 3mm thick UV-protected polycarbonate.

IKO Superlite Rooflight Upstands are available in heights up to 500mm. They are manufactured as standard from either multicell PVCu or insulated GRP, both of which provide an exceptionally robust and thermally efficient performance.

Product Benefits

- Extensive range of sizes from 400 x 400mm to 1700 x 2900mm
- Wide range of shape and glazing options
- Security features include a high security fixing system with optional integral burglar bars
- Wide range of ventilation and roof access options
- When installed with an IKO high performance roofing system IKO Superlite Rooflights are incorporated within the single point roof waterproofing guarantee



IKO Superlite Continuous and Specialist Rooflights



Monopitch

Monopitch (out-of-plane) rooflights are purpose-made continuous rooflights and are available in 0.6m to 6m sloped lengths, suited to a curb slope pitch of between 15-75°. Monopitch rooflights are manufactured from proprietary aluminium extrusions.

Available with hermetically sealed glass units or polycarbonate glazing systems the rooflights are installed on site into the aluminium system.

Each rooflight run is terminated with either a capping or a wall abutment section.



Ridgelights

Gable and Hip Ended Rooflights are purpose-made continuous Rooflights and are available in spans of 0.6m up to 7m, with a slope pitch of 15° to 60° although 30° is supplied as standard. Gable and Hip Ended Rooflights are manufactured from proprietary aluminium extrusions.

Available with hermetically sealed glass units or polycarbonate glazing systems the Rooflights are installed on site either to a site formed upstand or to a proprietary upstand.

Each rooflight run is terminated with glazed gable ends, hipped ends, wall abutments or open ends.



Pyramid

Pyramid Rooflights are purpose-made, self-supported Rooflights, and are available in spans of 0.6m up to 7m, with a slope pitch of 15° to 60° although 30° is supplied as standard. Pyramid Rooflights are manufactured from proprietary aluminium extrusions.

Available with hermetically sealed glass units or polycarbonate glazing systems the Rooflights are installed on site either to a site formed upstand or to a proprietary upstand.

Each rooflight is designed as having four equal sloped sides.



Tubular Skylights

These effectively transmit natural daylight to internal rooms or areas that do not receive adequate daylight.

Natural daylight is captured at roof level and directed downwards through rigid or flexible tubes and then diffused at ceiling level.

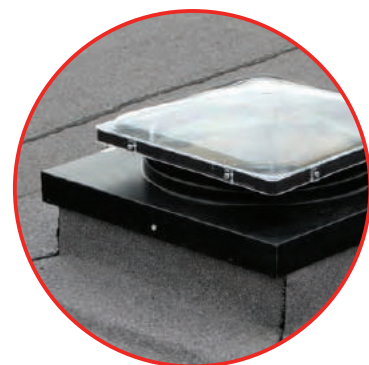

IKO Superlite Barrel Vault Rooflight



High quality continuous barrel vault Rooflights designed to make optimum use of natural light. These units are purpose made and are offered in a range of profiles and glazing options to meet virtually any specifier and client requirement.

IKO Superlite Continuous Barrel Vault Rooflight

IKO Superlite Continuous Barrel Vault Rooflights are high quality continuous Rooflights used to span openings up to 6m wide and unlimited in length.

Units consist of polycarbonate glazing and extruded aluminium sill sections, pre-formed curved glazing bars and capping profiles, available with solid single, double, triple, or multiwall glazing.

IKO Superlite Continuous Barrel Vault Rooflights are normally specified to fit to a site formed builder's curb, although subject to loading calculations, can be supplied with a proprietary range of upstands.

Opening and ventilation options are available.

System Benefits

- Solid, single, double, triple skin or multiwall
- Spans up to 6m and unlimited length
- Suited to new buildings and refurb applications
- High light efficiency giving excellent light distribution
- Available in low rise (1/6) and high rise (1/2)
- Building Regulation ADL compliant option

Certification & Performance

- IKO Superlite Continuous Barrel Vault Rooflights are 'out-of plane' rooflights
- The 'Non-Fragile' IKO Superlite polycarbonate rooflights have undergone large body impact testing by an independent accredited test organisation. Test certificates are available to demonstrate compliance to an energy level of 1,200 Joules when tested to EN 14963:2006 and ACR(M)001:2005 to Class B.
- IKO Superlite Polycarbonate Continuous Barrel Vault Rooflights are manufactured in accordance with European standards.



IKO Superlite Oversleeve Glazing



IKO Superlite Oversleeve Glazing is a cost-effective multi-walled polycarbonate glazing system that provides excellent thermal value, maximum light transmission and a long lifespan.

IKO Superlite Continuous Barrel Vault Rooflight

Particularly well suited to situations where existing glazing cannot be removed or when cost is prohibitive – usually buildings with clerestory and vertical glazing, tank rooms and façades with cladding materials such as asbestos.

The IKO Superlite Oversleeve Unit is available in translucent clear or translucent opal finish.

The aluminium framework is available in mill finish, polyester powder-coated white or to any RAL colour by special order. Bespoke corner flashings and wall abutment details are available in aluminium pressings to suit.



System Benefits

- Eliminates the need to remove existing glazing
- Cost-effective – especially against the cost of replacement glazing
- Fast and easy to install
- Minimises time on site, disruption, health & safety risks and waste disposal costs
- Thermally efficient – Can accommodate up to 200mm of insulation
- Superior U-Values help lower heating bills and reduce carbon footprint
- Wind-resistant and impact-resistant up to sports centre test standards
- No internal access required for installation
- Maintenance-free – Can be cleaned with diluted, mild detergent

Certification & Performance

- IKO Superlite Oversleeve Glazing and its associated products have been rigorously tested for durability, safety, thermal performance and compatibility with industry-standard roofing materials.
- The multiwall construction provides a consistent thermal barrier with excellent U-Values of 0.99W/m²K. The IKO Superlite Oversleeve system includes a choice of upstands dependent on window detail and insulation requirements.
- For ventilation within the upstand, there are both trickle vent or controllable rotating vent options. The maximum sheet length is 7m. Units are designed for vertical applications from 75° to 90°.

Detailing - Preformed Bituminous Details



IKO Preformed Roofing Upstands and IKO Preformed Drip Edges offer cost effective and rapid installation, these preformed bituminous details provide secure waterproofing and are durable and maintenance-free.

They are mechanically fixed to the substrate with hot air welded lap joints.

Preformed bituminous details provide secure waterproofing and are durable and maintenance-free.

System Benefits

- IKO Preformed Drip Edges come in 3m length
- Choice of colours to complement your roofing membranes

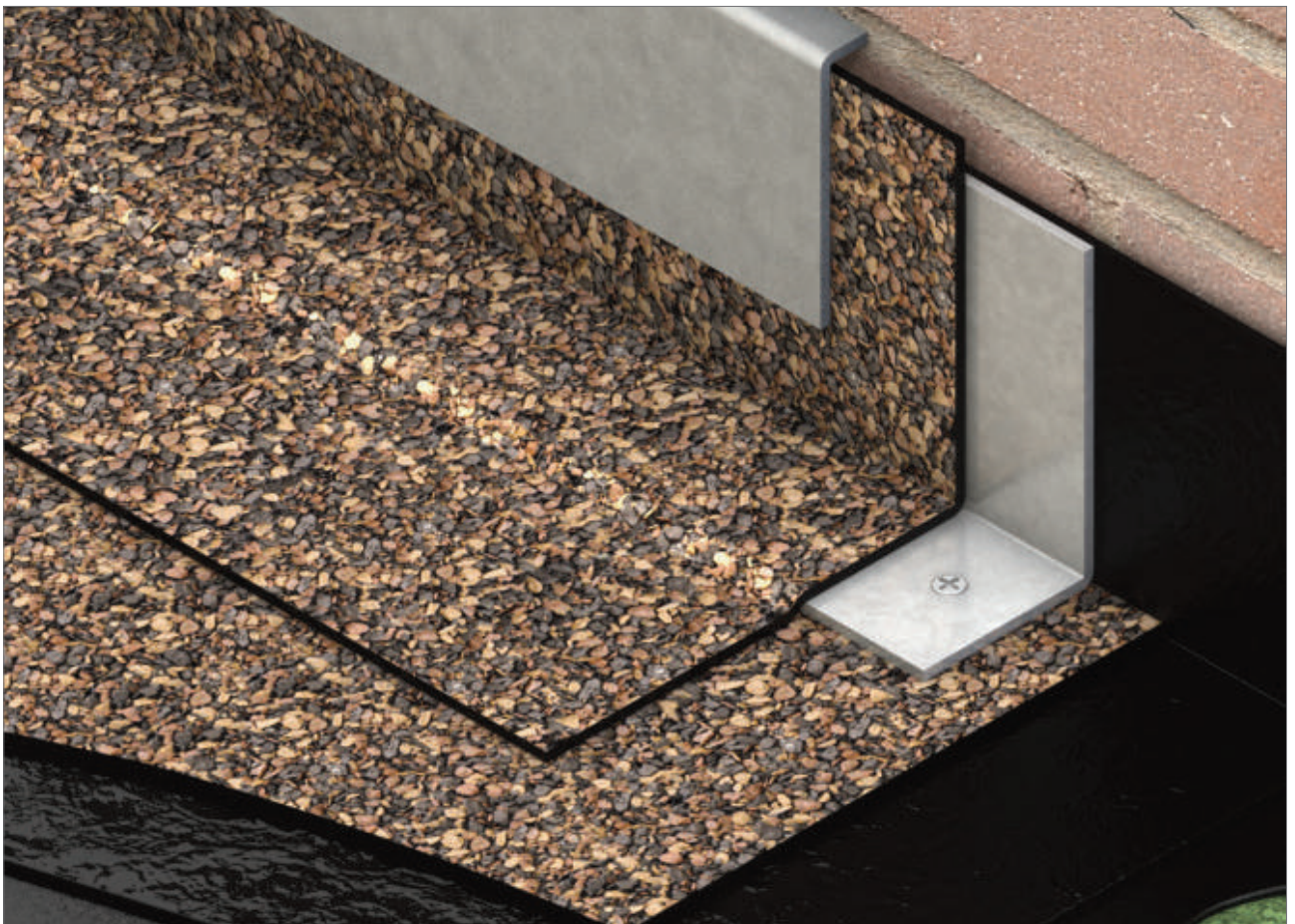

IKOfix - Integrated Fixing Point

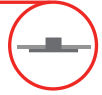

IKOfix Integrated Fixing Point provides a structural connection to the building substrate whilst maintaining the integrity of the cap-sheet, fixed to the substrate through the roofing membrane using appropriate fixings.

Designed for use on cold and warm roof constructions and can be used for applications where a connection to the building structure is required, such as using solar PV or solar thermal panels.

Comprising of only three main components:

- Pressed 3mm steel plate with polyester powder coating
- Membrane flange to suit field membrane system
- 304 Grade stainless steel connection point



System Benefits

- Fitting time under 10 minutes
- Compatible with solar panels
- All fixings covered by the Cap Sheet, not effecting the waterproofing integrity
- Warm roof and cold roof application
- Compatible with all IKO BUR Systems:
 - IKO UPXL
 - IKO Ultra Prevent
 - IKO Mach One
 - IKO Safestick Prevent
 - IKO Carrara
 - IKO Goldseal
 - IKO Roofgarden
 - IKO Quadra

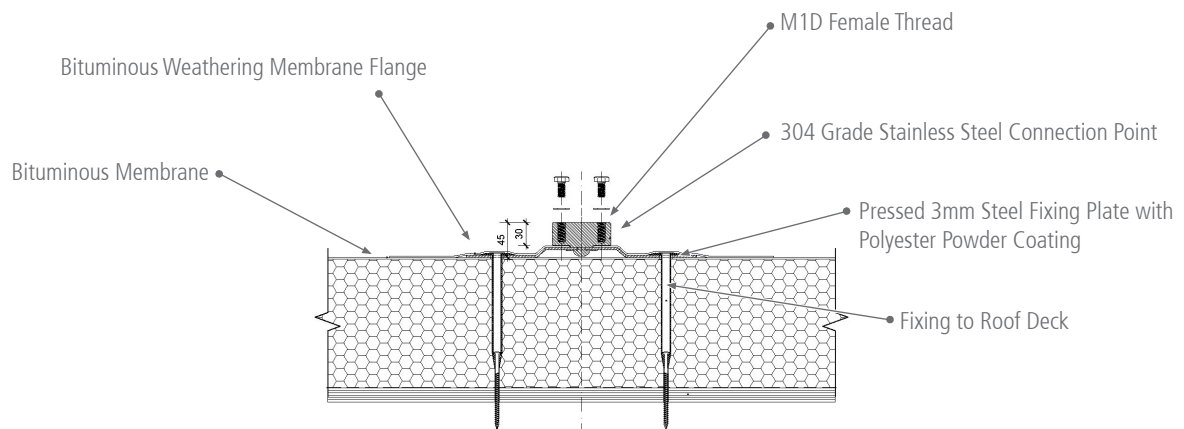

IKOfix on warm roof - section view

IKOtrim Roof Edge Trims and Wall Flashings Selector



The IKOtrim range incorporates the most popular GRP roofing trims for external finishing of typical perimeter details such as check kerbs and parapet walls. Suitable to use with most waterproofing types.

IKOtrim

IKOtrim profiles have a very low coefficient of thermal expansion minimising the problem of roof membranes tearing at the trim joints. The GRP composition of IKOtrim is highly resistant to atmospheric corrosion, making the product maintenance free.

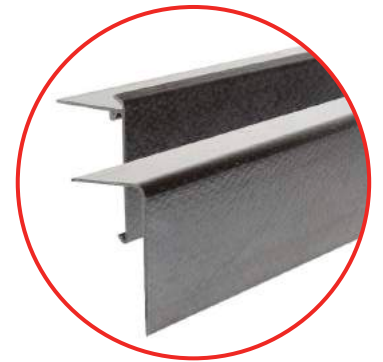

IKOtrim F (for bituminous membranes)

Manufactured from pultruded glass fibre reinforced polyester resin. IKOtrim F are thermally inert with low coefficient expansion.

Product Details

- Supplied in 3m lengths
- Matching internal/external corners are available
- Corner units are 240 x 240mm

Face *	Fixing Arm *	
40mm	60mm	
40mm	85mm	
65mm	60mm	
100mm	60mm	
150mm	60mm	

* Other variations of Face/Fixing Arm lengths are available on request.

IKOtrim F Colours		
Black	White	Grey

IKOtrim L (for cold-applied liquid systems membrane)

Manufactured from pultruded glass fibre reinforced polyester resin. They are thermally inert with a low coefficient of expansion.

Product Details

- Supplied in 3.0m lengths
- Matching internal/external corners are available
- Corner units are 240 x 240mm

Face	Fixing Arm	
100mm	60mm	

IKOtrim L Colours **
Grey

** Other colours are available on special order.

IKOtrim Wall Flashings

Used to cover the leading edge of an upstand detail, where the substrate does not allow the execution of a traditional chase or cover flashing detail.

Product Details

- Supplied in 3m lengths

Face	Fixing Arm
62mm	10mm

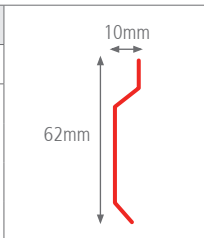



IKOtrim Wall Flashing Colours *

Black

* Other colours available on special order.

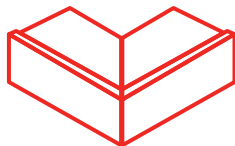
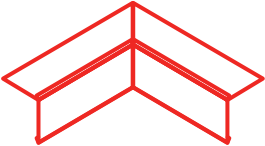
IKOtrim Standard size 90° External and Internal Corners

Pre-formed corners eliminate the need for on-site mitre cutting. They also ensure a neat, accurate and watertight detail at any change in roof edge direction.

External Corner	Internal Corner
	

IKOtrim Wall Corner Colours *

Black

* Other colours available on special order.

Angle Fillets



IKO High Performance Insulation Fillets

Alternative to angled wooden fillet, designed to reduce the corner angle from 90° to 45° and avoid cold spot.

Product Details

- Angle fillet with a high-performance PIR insulation core
- Available in bitumen coated or aluminium face for compatibility with bonded, self-adhesive and torch-on applications

Length	Width	Depth
1200mm	50mm	50mm



IKO Rainwater Outlets



IKO Aluminium Rainwater Outlets offer a wide choice of outlet designs that cater for most types of building drainage applications. IKO Rainwater Outlets provide optimum flow performance even in extreme rainfall conditions.

IKO Roof AV Vertical Rainwater Outlets

IKO Roof AV Vertical Rainwater Outlets are designed for use with flat roof structures using either insitu cast concrete, timber or lightweight metal deck construction. IKO Roof Outlets are ideal for connection to continuous waterproofing systems using single ply membranes, mastic asphalt, bituminous membranes and wet-applied systems.



IKO AV Retro-Gulley Outlets

IKO Roof AV Retro-Gulley Outlets are designed to fit within the existing outlet and pipework of the roof which is being upgraded. Because of minimal disturbance and the ease with which the retro-gulley is fitted, it represents an extremely cost-effective and efficient solution to flat roof upgrading.



IKO Two-Way Detail Outlets

IKO Roof Two-Way Detail Outlets are designed for applications where an angle is formed by the intersection of vertical and horizontal surfaces (for example, where a balcony or roof meets a parapet wall). They can be installed to provide either vertical or horizontal run-off and are suitable for use with most types of waterproofing membrane.



IKO Balcony Detail Outlets

IKO Roof Balcony Detail Outlets are designed for use with concrete balcony structures and are fitted with flat grates for safe drainage in pedestrian accessed areas. Balconies provide valuable living space and optimising the spatial use of balcony areas for recreational and environmental benefits is beneficial to both new build and refurbishment projects.



Further information on roof design can be found at www.ikogroup.co.uk
IKO Technical Department is available to give specific project design advice on **01257 256 864**

IKO Lightning Conductor Clips



IKO Lightning Conductor Clip

IKO Lightning Conductor Clips consist of a purpose made clip which is mechanically fixed to an IKO Ultra Prevent Torch-On membrane pad (approximate size 95mm x 95mm).

They are available in black, brown and green to match the finish of most IKO specification systems.



Product Details

- Pre-fixed to membrane for ease of installation
- Compliment most IKO specification systems
- Allows for thermal movement
- Purpose made clip

IKO Clip Colours		
		
Black	Brown	Green Mineral

Recovery Board

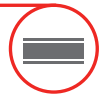

IKO Protectoboard

IKO Protectoboard is a protection and roof recovery board fabricated with a bituminous core sandwiched between two layers of non-woven glass-fibre reinforcement.

IKO Protectoboard offers durable and reliable performance and is fully compatible with a range of bituminous and non-bituminous waterproofing systems and comes in a variety of lengths.

Product Details

- Used for existing surface preparation or finished waterproofing protection
- Robust and dimensionally stable
- 3.2mm thick (standard grade)
- Various board size options
- Mechanically fixed or bonded in bitumen / PU adhesive
- Easily cut and formed on site
- Easily stored, requiring minimum storage space
- Can directly receive torch-on, bitumen bonded or self-adhesive roofing membranes





The IKOrail range of guardrail edge protection systems is ideal for collective fall protection on flat roof areas. IKOrail offers system solutions for different roof edge conditions. All systems are supplied in kit form, making them quick and simple to design and install.

Systems comprise the minimum number of well-scoped components, facilitating ease of specification and ordering and the innovative modular design eliminates the need for costly on-site bending and welding.

IKOrail Freestanding Guardrail System

This popular free-standing system is a non-penetrative edge protection solution that relies upon a proven counterbalance weight rather than a mechanical fastener to provide the requisite stability. The system also includes a rubber pad that minimises the risk of damage to the underlying waterproofing layer.



IKOrail Parapet Guardrail System

The IKO Parapet Guardrail system uses a fully-adjustable bracket that clamps over the existing parapet wall, with the flexibility to accommodate a range of parapet wall widths. Further adjustment is provided by the sliding top riser, allowing the overall height of the top rail to be tailored to suit project specific requirements.



IKOrail Topfix Guardrail System

The IKOrail Topfix Guardrail system is simply mechanically secured to the top of the wall or coping. The system is equally applicable to the provision of permanent edge protection solutions for stairwells, shafts and loading bays. Options for fixing to metal roofing systems are available via the addition of the IKOrail Guardrail Extended Base Plate.



Additional Information



Certificates & Accreditations	
CE Marking	In accordance with harmonised European Standards BS EN 13374: 2004 Class A
Health and Safety Executive's	HSE INDG 284 "Working on roofs"
Health and Safety at Work	HSG33
Wind Load Code	BS6399: Part 2 1995



Further information on roof design can be found at www.ikogroup.co.uk
 IKO Technical department is available to give specific project design advice on **01257 256 864**

IKO D-marc™ 105 Wind-Resistant Demarcation System



Traditional demarcation systems on rooftop applications suffer from instability and wind uplift causing them to fly off roofs at wind speeds as low as 50mph. IKO D-marc™ 105 has been wind tunnel tested on single ply, bituminous and concrete.

IKO D-marc™ 150

Wherever roof access is required, designers are tasked with creating a safe route which should be identified by a demarcation system. Applications may be for the purpose of preventing access to hazards during regular rooftop maintenance or to provide safe access across the roof.

IKO D-marc™ 105 when installed will create a barrier system with an average installed height of 950mm. The sizing of the components that make up the system allow it to be packaged on a single pallet minimising packaging and waste.

To calculate the required number of uprights and bases the required length of system should be divided by three and then add one. For example a 21m length system requires 8 uprights and 8 bases. The chain comes in 25m lengths and can be cut to size or joined using the chain links supplied.



Image	Items	Description	Dimensions
	Base*	The base is manufactured from recycled tyres complying with BS 4790 for flammability, BS 1006 for UV stability and BS 7188 for slip resistance.	
	Upright*	The uprights are manufactured from a 304 stainless steel to EN 1.4301. The powder coating process not only enhances lifespan, but provides a quality finish to the product.	
	Links & Connecting Link	The plastic chain and connecting links are fully weatherproof, resistant to salt, chemicals and frost. They are also colour-fast, anti-magnetic and can be used within a temperature range of -10°C and +75°C.	

* International patent pending PCT/GB2009/000701. UK patent pending GBO901935.7



Further information on roof design can be found at www.ikogroup.co.uk
 IKO Technical Department is available to give specific project design advice on **01257 256 864**

IKO Paving Support Pads



IKO Paving Support Pads allow paving to be laid on waterproofing membranes, facilitating the transformation of flat roof areas into patios, terraces, balconies and walkways.

IKO Adjustable Paving Support Pads

IKO Adjustable Paving Support Pads are an effective way of creating a void beneath the slabs large enough to conceal pipes, cables and other utility installations and services. IKO Adjustable Paving Support Pads are designed to be used where fine adjustment in height is required in order to obtain a level paved area on a roof deck. This is normally the case where the roof has been laid to falls for drainage, or where the deck is uneven.

They are also an effective way of creating a void beneath the slabs large enough to conceal pipes, cables and other utility installations and services. Slabs can be easily removed, allowing maintenance to be carried out.



System Benefits

- Manufactured from heavy duty, chemical resistant, solid polypropylene
- Adjustable, simple and easy to install
- Certified compression test data available on request
- Incorporate spacing nibs to maintain a consistent drainage gap between paving

Sizes

Height	Base Diameter
40-56mm	210mm
50-70mm	210mm
70-110mm	210mm

Height	Base Diameter
110-160mm	220mm
150-210mm	220mm
200-300mm	220mm

IKO Paving Support Pads and Shims



IKO Paving Support Pads and Shims are manufactured from heavy duty, chemical resistant, solid polypropylene; incorporate spacing nibs to maintain a consistent drainage gap between pavings. They are easily divided into halves and quarters, for use at edges and corners of paved areas. IKO Paving Support Pads are primarily for use on consistent and level flat roof areas.

IKO Paving Support Pads

IKO Paving Support Pads incorporate spacing nibs to maintain a consistent drainage gap between paving's. They are easily divided into halves and quarters, for use at edges and corners of paved areas. IKO Paving Support Pads are primarily for use on consistent and level flat roof areas.



IKO Paving Support Shim

IKO Paving Support Pad Shims offer a finer level of support. They are easily divided into halves and quarters, for use at edges and corners of paved areas. IKO Paving Support Shims are primarily for use on slightly uneven flat roof areas.





Lead-Free Flashing

IKOflash Lead-Free Flashing

IKOflash is a lead-free flashing which can be used in areas where traditional lead flashing would be used such as chimney and abutment flashings, around rooflights and pitched valley linings. IKOflash is made from a modified polyethylene compound with an integral aluminium mesh reinforcement, enabling the product to be worked and formed in the same way as lead. The product is faced with a fine grey mineral.



System Benefits

- Lighter - 80% lighter than lead and easier to handle
- Faster - Rapid installation, up to 50% quicker
- Flexible - Can be worked and formed in the same way as lead
- Cost effective - No scrap or resale value therefore less risk of theft
- Environmentally Friendly - IKOflash is non-toxic and recyclable

Product Details

Roll Size	Thickness	Weight
150mm x 6m	3.5mm	3.60kg
250mm x 6m	3.5mm	6.00kg
300mm x 6m	3.5mm	7.20kg
400mm x 6m	3.5mm	9.60kg

Roll Size	Thickness	Weight
150mm x 12m	3.5mm	7.20kg
250mm x 12m	3.5mm	12.00kg
300mm x 12m	3.5mm	14.40kg
400mm x 12m	3.5mm	19.20kg



Liquids for the Professional

IKOpro Stickall

IKOpro Stickall is a dense, all weather, bituminous sealing glue that remains plastic under normal temperatures and adheres well to most building surfaces including wet surfaces. It is a multi-purpose product with high permanent adhesive strength, good UV stability and resistance to sagging at high temperatures.

The coverage is dependent on the depth and severity of the damage to be repaired; around 3m for a 1x1cm grout.

System Benefits

- Long lasting sealant adhesive
- Sealing mastic in conjunction with IKOflash
- Used to seal cracks and blisters on felt roofs as a sealant, along the edges of ridge tiles and between laps or around bolt holes on sheeted roofs
- Around rooflights and for repairing of gutters
- Finishing mastic for sealing rainwater pipes, chimneys and all sorts of roof penetrations
- Cold applied adhesive for additional bonding of bituminous shingles
- Sealing corrugated sheet accessories





annex



Liquid Applied Waterproofing

IKO Polimar FCS Roof Waterproofing is a highly durable system for both refurbishment and new build projects, which offers the additional benefit of rapid curing.



IKO Polimar FCS Primers

Image	Description	Consumption Rate	m ² per Unit	Size
	IKO Polimar FCS (Fast Curing System) Primer - Clear	0.5kg/m ²	20m ²	10kg (drum)
	Two-component, fast-reactive and flexible PMMA based resin primer for porous, bitumen and mineral substrates such as concrete, timber, bitumen felt and asphalt. Requires: Min. 2 x 100gsm IKO Polimar FCS Catalyst bag			
	IKO Polimar FCS Metal Primer	0.2kg/m ²	5m ²	1kg (drum)
	Single component ready to use, fast-reactive primer for metal substrates.			
	IKO Polimar FCS Viscosity Primer	0.4kg/m ² (smooth)	25m ²	10kg (drum)
		0.5kg/m ² (fine)	20m ²	10kg (drum)
		0.8kg/m ² (rough)	12m ²	10kg (drum)
	Two-component, fast-reactive primer for concrete and porous substrates such as car decks where high penetration primers are required. Requires: Min. 2 x 100gsm IKO Polimar FCS Catalyst bag			
	IKO Polimar FCS Concrete Primer	0.4kg/m ² (smooth)	25m ²	10kg (drum)
		0.5kg/m ² (fine)	20m ²	10kg (drum)
		0.8kg/m ² (rough)	12m ²	10kg (drum)
	A two-component, fast-reactive and flexible PMMA-based resin primer for concrete substrates. Requires: Min. 2x100gsm IKO Polimar FCS Catalyst bag			
	IKO Polimar FCS Bitumen Primer	0.4kg/m ² (smooth)	25m ²	10kg (drum)
		0.5kg/m ² (fine)	20m ²	10kg (drum)
		0.8kg/m ² (rough)	12m ²	10kg (drum)
	Two-component, fast-reactive and flexible PMMA-based resin primer for bitumen and asphalt substrates. Requires: Min. 2 x 100gsm IKO Polimar FCS Catalyst bag			





IKO Polimar FCS Substrate Preparation

Image	Description	Consumption Rate	m ² per Unit	Size
	IKO Polimar FCS Filler	Variable	Variable	10kg (drum)
	Two-component, fast-reactive and flexible PMMA-based product used to fill small cracks and joints as well as to smooth out areas of minor unevenness. Requires: Min. 2 x 100gsm IKO Polimar FCS Catalyst bag			
	IKO Polimar FCS Reinforced Filler	Variable	Variable	10kg (drum)
	Two-component, fast-reactive and highly flexible, fibre-filled waterproofing product for sealing small and intricate details where fleece reinforced waterproofing is difficult to use. For bolts and voids that require more body. Requires: Min. 2 x 100gsm IKO Polimar FCS Catalyst bag Colour: Dark Grey (RAL 7043)			
	IKO Polimar FCS Mortar	Variable	Variable	10kg (drum)
	Fast-reactive repair and levelling mortar used for filling and smoothing over faults and cavities in the substrate. Can also be used to provide falls and fill larger voids. Two-component system: IKO Polimar FCS Levelling mortar Part B (9kg activated filler mix) and Part A (1kg resin) included inside the drum. Colour: Dark Grey (RAL 7043)			

IKO Polimar FCS Liquid Coatings

Image	Description	Consumption Rate	m ² per Unit	Size
	IKO Polimar FCS Waterproofing	2.5kg/m ² (smooth)	4m ²	10kg (drum)
		3.0kg/m ² (fine)	3.3m ²	10kg (drum)
		2.8kg/m ² (rough)	2.8m ²	10kg (drum)
	Two-component high-grade, PMMA-based waterproofing resin with low-temperature flexibility, used to provide durable reinforced waterproofing in areas such as roofing, balconies, walkways and car parks as part of the IKO Polimar FCS Systems. Requires: Min. 2 x 100gsm IKO Polimar FCS Catalyst bag Colour: Dark Grey (RAL 7043)			
	IKO Polimar FCS Low Odour Waterproofing	2.5kg/m ² (smooth)	4m ²	10kg (drum)
		3.0kg/m ² (fine)	3.3m ²	10kg (drum)
		2.8kg/m ² (rough)	2.8m ²	10kg (drum)
	A two-component high-grade, PMMA-based waterproofing resin with low-temperature flexibility, used to provide durable reinforced waterproofing in areas such as roofing, balconies, walkways and car parks as part of the IKO Polimar FCS Systems. Requires: Min. 2 x 100gsm IKO Polimar FCS Catalyst bag Colour: Light Grey (RAL 7047)			

IKO Polimar FCS Liquid Coatings

Image	Description	Consumption Rate	m ² per Unit	Size
	IKO Polimar FCS Detailing	2.5kg/m ² (smooth)	4m ²	10kg (drum)
		3.0kg/m ² (fine)	3.3m ²	10kg (drum)
		2.8kg/m ² (rough)	2.8m ²	10kg (drum)
	Two-component fast-reactive, thixotropic and highly flexible PMMA-based waterproofing resin with low-temperature flexibility, used to provide durable reinforced waterproofing in areas such as roofing, balconies, walkways and car parks as part of the IKO Polimar FCS Systems. Requires: Min. 2 x 100gsm IKO Polimar FCS Catalyst bag Colour: Dark Grey (RAL 7043)			
	IKO Polimar FCS Sealer	2.2kg/m ²	6.8m ²	15kg (drum)
	Two-component high-grade, mechanically durable finish which can be used for creating patterns and lettering. Different toppings can be incorporated into the system to achieve the desired slip-resistant properties. Requires: Min. 2 x 100gsm IKO Polimar FCS Catalyst bag Colour: Light Grey (RAL 7032), Mid Grey (RAL 7030) & Dark Grey (RAL 7043) (Bespoke colour available on request based on RAL or BS colours)			
	IKO Polimar FCS Surfacing	0.5kg/m ²	20m ²	1kg (drum)
	Two-component fast-reactive, abrasion-resistance and skid-resistant, PMMA-based wearing layer, used in car park applications as a slip resistant finish. Requires: Min. 2 x 100gsm Polimar FCS Catalyst bag			
	IKO Polimar FCS Heavy Duty Surfacing	3.5kg/m ²	4.2m ²	15kg (drum)
	Two-component fast-reactive, abrasion-resistance and skid resistant, PMMA-based heavy duty wearing layer used in car park applications in high-wear areas such as ramps. Min. 2 x 100gsm IKO Polimar FCS Catalyst bag			
	IKO Polimar FCS Wear Course	4.0kg/m ²	8m ²	33kg (kit)
	A waterproofing resin mixed with filler and catalyst to create a trowelable mortar, used in IKO approved trafficable surfacing and waterproofing systems. Requires: IKO Polimar FCS Wear Course Part A (23kg Powder), Part B (10kg Resin), and IKO Polimar FCS Catalyst (2 x 100gm bags minimum).			

IKO Polimar FCS Ancillaries

Image	Description	Consumption Rate	m ² per Unit	Size
	IKO Polimar FCS Catalyst	n/a	Variable	100gsm (bag)
An essential component of PMMA-based IKO Polimar products. It both starts and adjusts the curing reaction. The speed of the reaction is adjusted to the ambient conditions by modifying the amount of catalyst added.				

Image	Description	Consumption Rate	m ² per Unit	Size
	IKO Polimar FCS Reinforcement Fleece	n/a	Variable	1.05x50m (rolls)
A synthetic fibre fleece specially designed as reinforcement for use with IKO Polimar FCS Waterproofing resins. 100gsm polyester fleece for main field areas. Roll Weight, 5.25kg				



Image	Description	Consumption Rate	m ² per Unit	Size
	IKO Polimar FCS Quartz Aggregate	2.0kg/m ²	12.5m ²	25kg (bag)
Slip Resistant Finishes for balconies, walkways, terraces and access walkways. R12 slip resistance.				

Image	Description	Consumption Rate	m ² per Unit	Size
	IKO Polimar FCS Deco Chips	0.05kg/m ²	20m ²	1kg tub
Loose flake toppings specifically designed to give a decorative finish to IKO Polimar FCS Sealer coats. Offering design options for the finished surface, while also optimising its slip resistant property. R10 slip resistance. Colour: White, Grey & Black				

Description	Consumption Rate	m ² per Unit	Size
IKO Polimar FCS Cleaner - Multi-purpose and effective cleaner for removing uncured Polimar resin from installation tools.	n/a	n/a	10L

IKO Polimar FCS Cleaning Bucket	n/a	n/a	19L
---------------------------------	-----	-----	-----





IKO Polimar FCS Mixing Bucket	n/a	n/a	32L
-------------------------------	-----	-----	-----







Liquid Applied Waterproofing

IKO Polimar is a high performance range of liquid waterproofing systems. Regardless of application, IKO Polimar Systems are extremely versatile, completely cold applied and can be specified to match the longevity of your project through a range of build-up options.





IKO Polimar Primers Product List

Image	Description	Consumption Rate	m ² per Unit	Size
 <p>PRODUCT IMAGE NOT YET AVAILABLE</p>	IKO Polimar AP (All Purpose) Primer	11L/m ²	55m ²	5ltr
	<p>A primer based on a complex blend of high molecular weight isocyanate, prepolymers blended with anti-corrosive pigments and silica fillers. Polimar AP is used to prepare exposed metal surfaces before the application of Polimar CRS (Cladding Refurbishment System). Can be applied by brush, roller or airless spray.</p>			
 <p>PRODUCT IMAGE NOT YET AVAILABLE</p>	IKO Polimar MC (Metal Coating) Primer	0.1L/m ²	Variable	Base: 3.75/15ltr Activator: 1.25/3ltr
	<p>A two-component (base + activator), high performance anti-corrosive epoxy coating designed for use as a versatile, universal primer on a wide range of metal surfaces. The mixing ratio is 3 parts IKO Polimar MC Base to 1 part IKO Polimar MC Activator (by volume).</p>			
	IKO Polimar GP (General Purpose) Primer	0.12L/m ² (smooth) 0.3L/m ² (rough)	Variable	5ltr & 25ltr
	<p>A single-component, high performance, low viscosity primer designed for use as a multipurpose sealing and priming system for porous mastic asphalt and cementitious roof substrates prior to the application of IKO Polimar EC/UV liquid roofing systems.</p>			
	IKO Polimar CRS (Cladding Refurbishment System) Primer	0.4ltr/m ²	12ltr/m ²	5ltr
	<p>An anti-corrosive intermediate coating for use in conjunction with roof coatings and cladding finishes. Low Sheen.</p>			

IKO Polimar Liquid Coatings

Image	Description	Consumption Rate	m ² per Unit	Size
	IKO Polimar EC (Embedment Coat)	15 year specification 1.2ltr/m ² (smooth) 1.5ltr/m ² (rough) 20 year specification 2ltr/m ² (smooth) 2ltr/m ² (rough)	Variable	12.5ltr
A single-component, liquid applied high performance, polyurethane coating incorporating a moisture triggered curing system for use on most roof surfaces. IKO Polimar EC forms the first part of the IKO Polimar EC/UV Liquid Applied Roofing System.				
	IKO Polimar UV (Ultraviolet)	0.5ltr/m ²	25m ²	12.5ltr
A single-component, liquid applied high performance polyurethane coating incorporating a moisture triggered curing system for use on most roof surfaces. IKO Polimar UV forms the final coating of the IKO Polimar EC/UV Liquid Applied Roofing System.				
	IKO Polimar CRS Seal	1.0 - 1.25ltr/m ² coat	Variable	5ltr
A waterproofing membrane coating for the protection of sound flat and pitched roofs.				
	IKO Polimar CRS Finish	6.7ltr/m ²	67m ²	10ltr
A protective finish for the renovation of factory coated profile metal vertical cladding panels and roofing trims.				
	IKO Polimar CRS Glaze	3ltr/m ² (reinforced) 4ltr/m ² (unreinforced)	Variable	5ltr
A UV and weather stable elastomeric membrane for protection, refurbishment and upgrading of plastic rooflights. Applied as a two coat system with or without reinforcement.				

IKO Polimar Ancillaries

Image	Description	Consumption Rate	m ² per Unit	Size
	<p>IKO Polimar GRF (Glass Reinforced Polyester) Reinforcement Fleece</p> <p>A high performance fleece that is embedded within the IKO Polimar Base Embedment Coat for total reinforcement of all types of flat roofs. Available in two weights; 100gsm and 225gsm to be specified depending upon on performance and guarantee requirements.</p>	n/a	100m ²	1 x 100m (rolls)
	<p>IKO Polimar GRF Reinforcement Strips</p> <p>Available pre-cut in a box, in a choice of two grades; 100gsm and 225gsm depending on system performance requirement. IKO Polimar GRF Strips handy format helps contractors reduce material waste, is less labour intensive and speeds up the installation process.</p> <p>Box Quantity: 100gsm = 150 & 225gsm = 100</p>	n/a	Variable	0.25x1m
	<p>IKO Polimar KRM (Knitted Reinforcement Mesh)</p> <p>A nylon reinforcing mesh used on all panelled joints and bolt heads, capable of stretching within the membrane to accommodate thermal and minor building movement. IKO Polimar KRM is designed to provide flexible independent movement joints in areas of differential movements or cracking up to 10mm wide.</p>	50 linear meter	n/a	0.19x50m
	<p>IKO Polimar BT (Bridging Tape)</p> <p>A non-bituminous tape used to bridge all gaps, joints and seams where movement is likely to occur. The bridging tape self-adhesive backing should be pressed firmly onto the substrate surface and care should be taken to ensure that the edges are firmly pressed down flush with the surface profile.</p>	45 linear meter	n/a	0.75x45m
	<p>IKO Polimar CRS Tape (Butylene Fleece)</p> <p>A non-bituminous tape used to bridge all gaps, joints and seams where movement is likely to occur. The bridging tapes self-adhesive backing should be pressed firmly onto the substrate surface and care should be taken to ensure that the edges are firmly pressed down flush with the surface profile.</p>	n/a	n/a	0.75x10m



case studies

Bituminous Reinforced Systems	128
Cold Applied Liquid Waterproofing Systems	133
Pitched Roofing	137



[ikogroup.co.uk/case-studies](http://www.ikogroup.co.uk/case-studies)



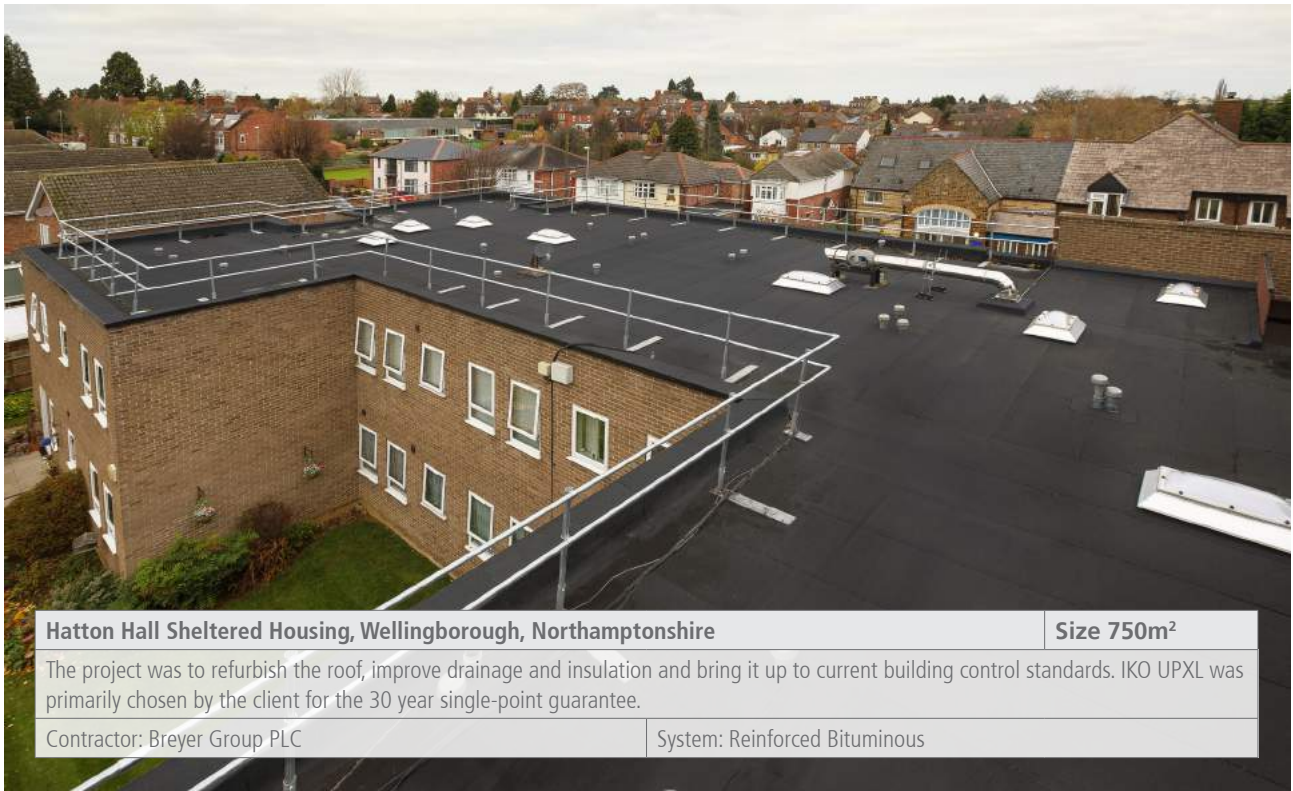

Hatton Hall Sheltered Housing, Wellingborough, Northamptonshire	Size 750m²
The project was to refurbish the roof, improve drainage and insulation and bring it up to current building control standards. IKO UPXL was primarily chosen by the client for the 30 year single-point guarantee.	
Contractor: Breyer Group PLC	System: Reinforced Bituminous



Erskine Court, Southampton	Size 2,000m²
A waterproof roofing system was required that would provide a long-term solution and deliver quality and value for money for a new housing development. IKO UPXL system offered a 30 year single-point guarantee which was paramount to the project.	
Contractor: Salnor Roofing Services Ltd	System: Reinforced Bituminous

 ikogroup.co.uk/case-studies



Portslade Academy, Brighton

Size 4,000m²

The 24 roofs, ageing from the 50s to the 90s were in poor condition due to the nature of the site, a hybrid system was selected by the client in order to reduce the use of hot works and for its excellent waterproofing performance.

Contractor: Clarke Roofing

System: Reinforced Bituminous

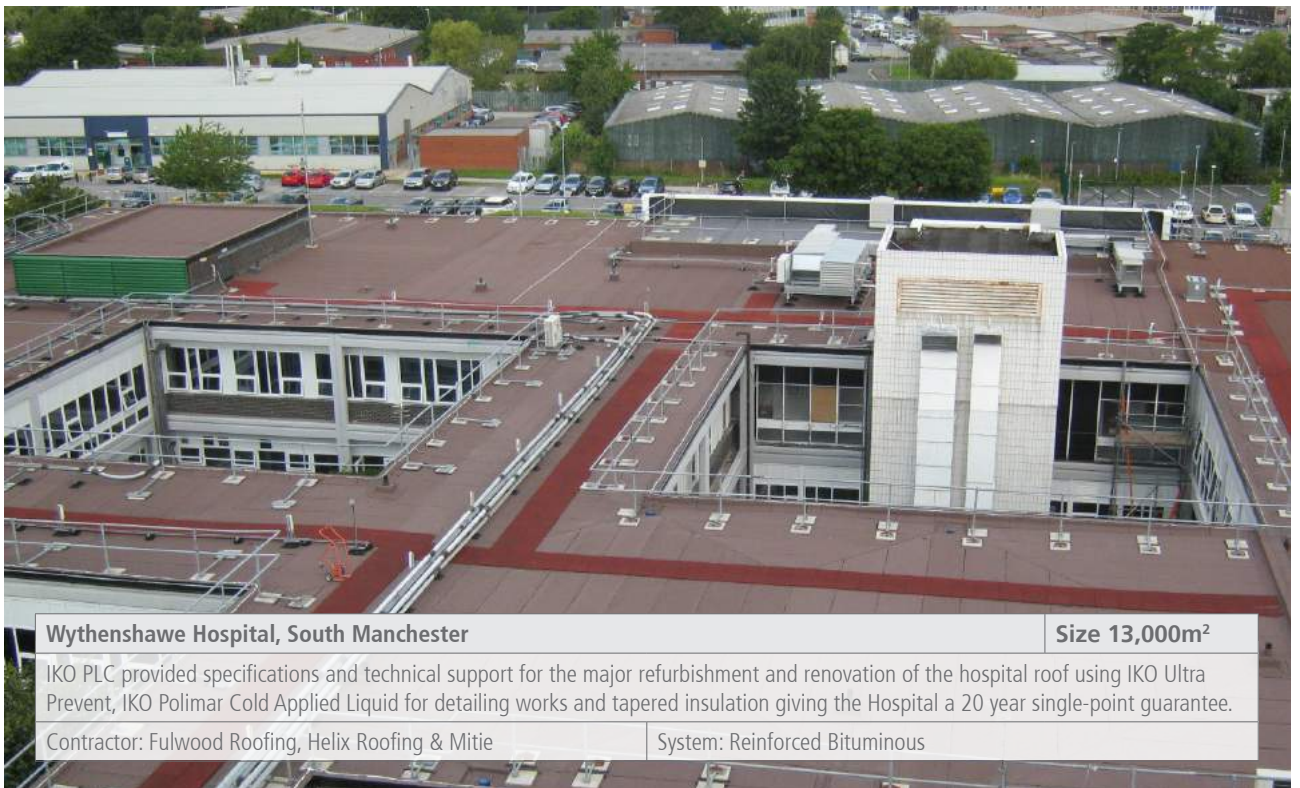

Wythenshawe Hospital, South Manchester

Size 13,000m²

IKO PLC provided specifications and technical support for the major refurbishment and renovation of the hospital roof using IKO Ultra Prevent, IKO Polimar Cold Applied Liquid for detailing works and tapered insulation giving the Hospital a 20 year single-point guarantee.

Contractor: Fulwood Roofing, Helix Roofing & Mitie

System: Reinforced Bituminous



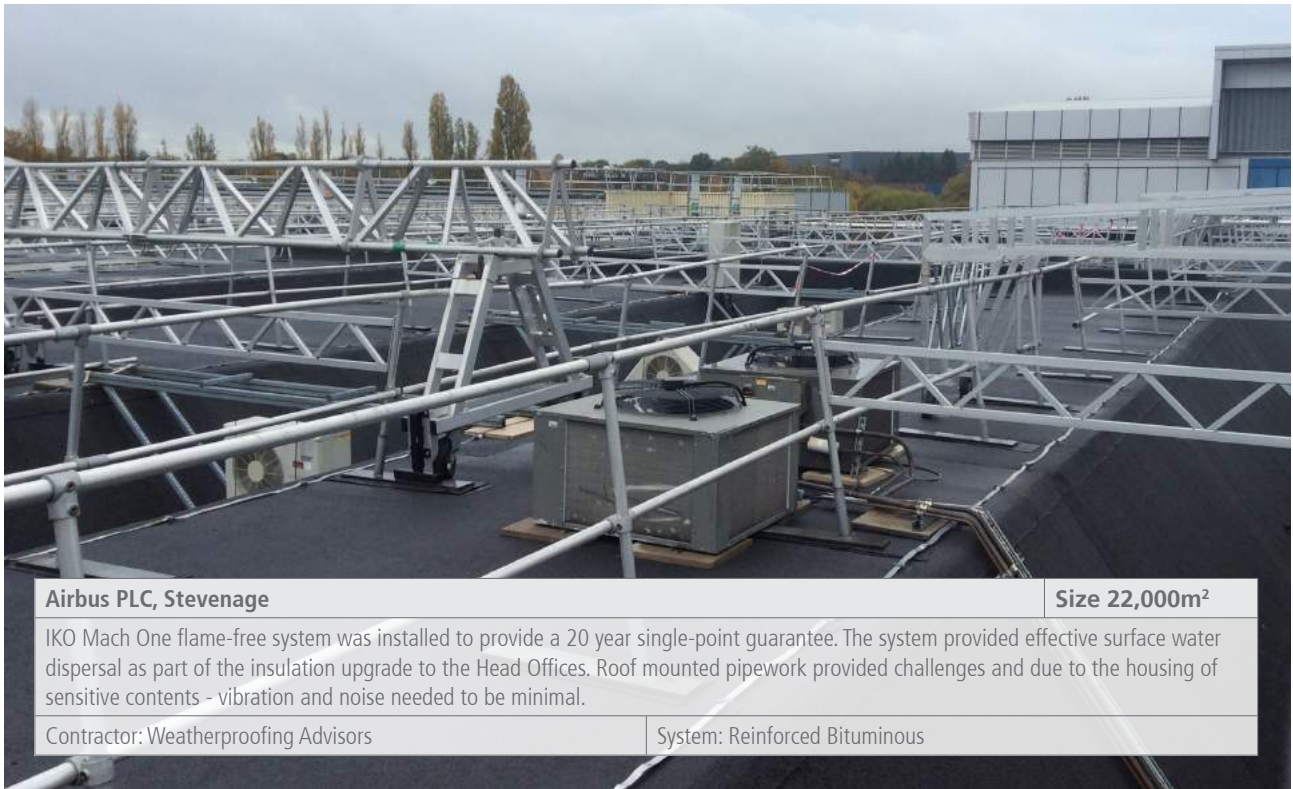

Airbus PLC, Stevenage

Size 22,000m²

IKO Mach One flame-free system was installed to provide a 20 year single-point guarantee. The system provided effective surface water dispersal as part of the insulation upgrade to the Head Offices. Roof mounted pipework provided challenges and due to the housing of sensitive contents - vibration and noise needed to be minimal.

Contractor: Weatherproofing Advisors

System: Reinforced Bituminous



Cramlington Learning Village, Gateshead

Size 2,000m²

A combination of IKO Mach One and IKO Superflex T-O Cap Sheets were installed along with new insulation boards to complete a full tapered scheme to reduce persistent standing water.

Contractor: Kier Services, DVC Roofing

System: Reinforced Bituminous



ikogroup.co.uk/case-studies



Euston Station, London	Size 55,000m²
IKO Mach One flame-free system was specified to overlay the parcel and concourse roof. IKO Polimar Cold Applied Liquid System was used to cover the platform roof and the 137 Georgian wired glazed units were also replaced.	
Contractor: Weatherproofing Advisors	System: Reinforced Bituminous



North Street, Bristol	Size 550m²
The existing decking and waterproofing system were removed and reinstated with a new deck and IKO Safestick Self-Adhesive, high-performance waterproofing system, ignore the upgrade of the insulation to meet new U-value requirement.	
Contractor: Davis Roofing Bristol	System: Reinforced Bituminous



Ridgeway High School, Prenton

IKO Carrara is an ecological built-up roofing membrane, combining a variety of ingenious technologies for the improvement of the environment.

System: Reinforced Bituminous

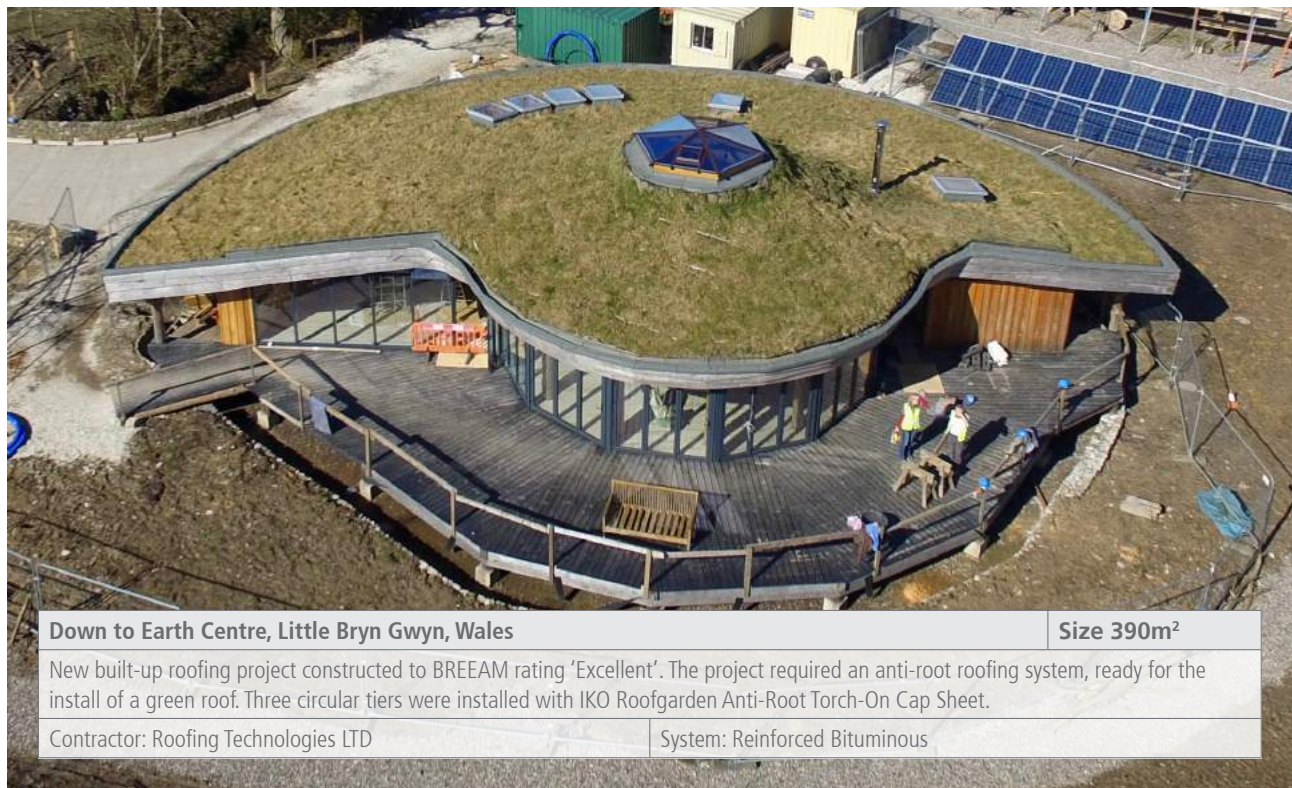

Down to Earth Centre, Little Bryn Gwyn, Wales

Size 390m²

New built-up roofing project constructed to BREEAM rating 'Excellent'. The project required an anti-root roofing system, ready for the install of a green roof. Three circular tiers were installed with IKO Roofgarden Anti-Root Torch-On Cap Sheet.

Contractor: Roofing Technologies LTD

System: Reinforced Bituminous



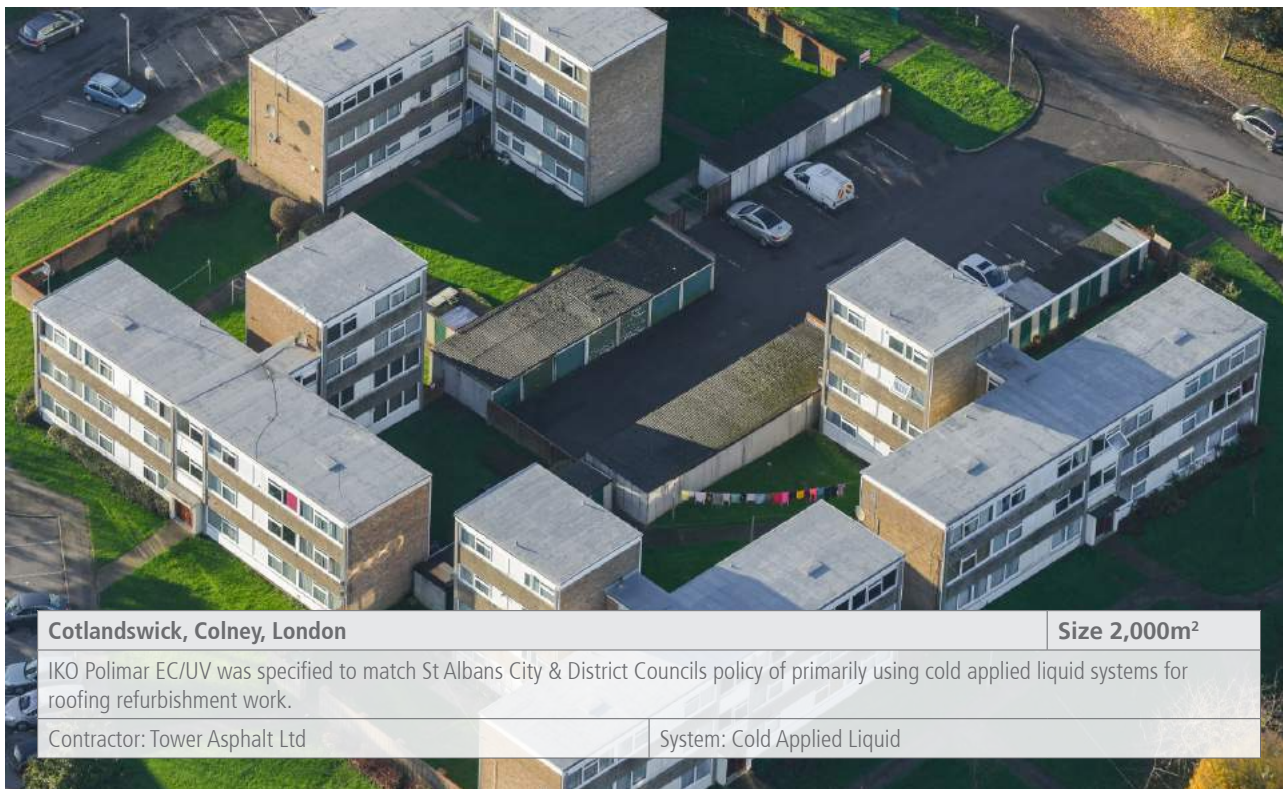

Cotlandswick, Colney, London

Size 2,000m²

IKO Polimar EC/UV was specified to match St Albans City & District Councils policy of primarily using cold applied liquid systems for roofing refurbishment work.

Contractor: Tower Asphalt Ltd

System: Cold Applied Liquid

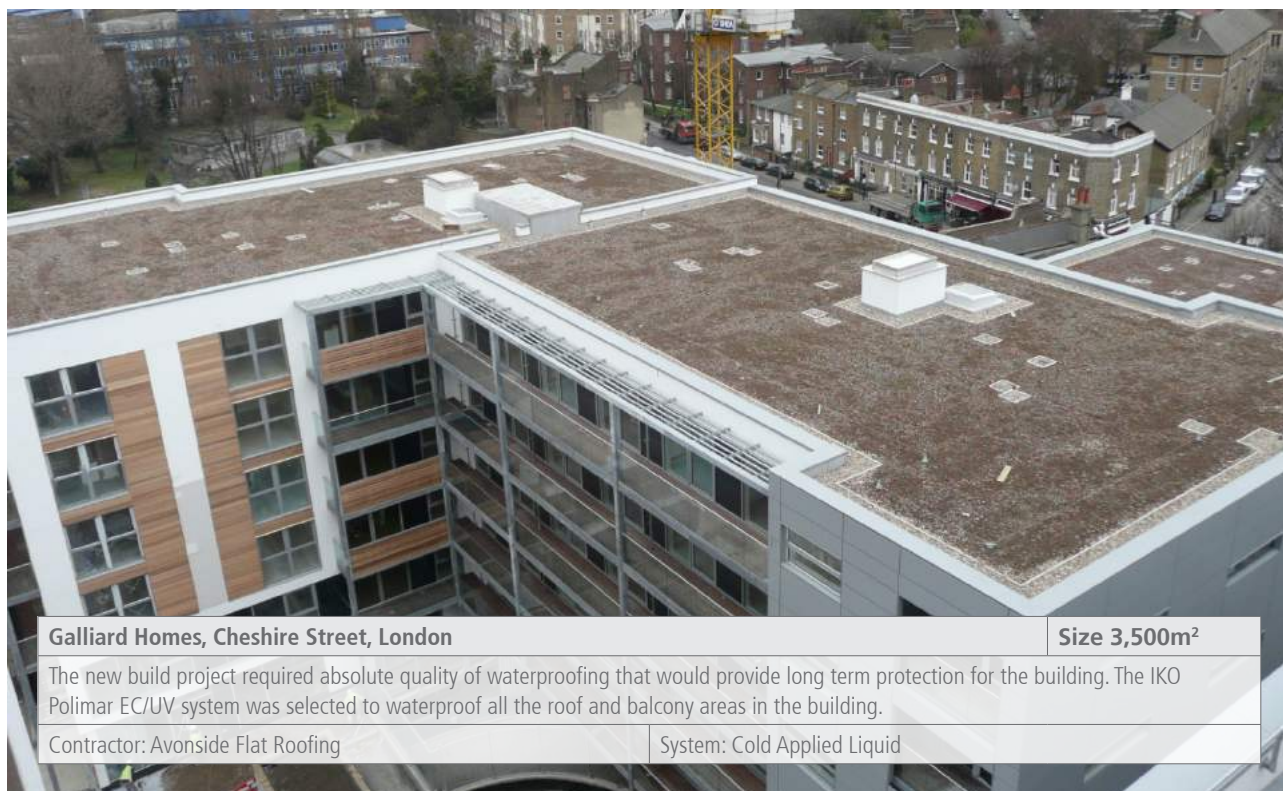

Galliard Homes, Cheshire Street, London

Size 3,500m²

The new build project required absolute quality of waterproofing that would provide long term protection for the building. The IKO Polimar EC/UV system was selected to waterproof all the roof and balcony areas in the building.

Contractor: Avonside Flat Roofing

System: Cold Applied Liquid

IKO polimar EC/UV
Liquid Applied Waterproofing

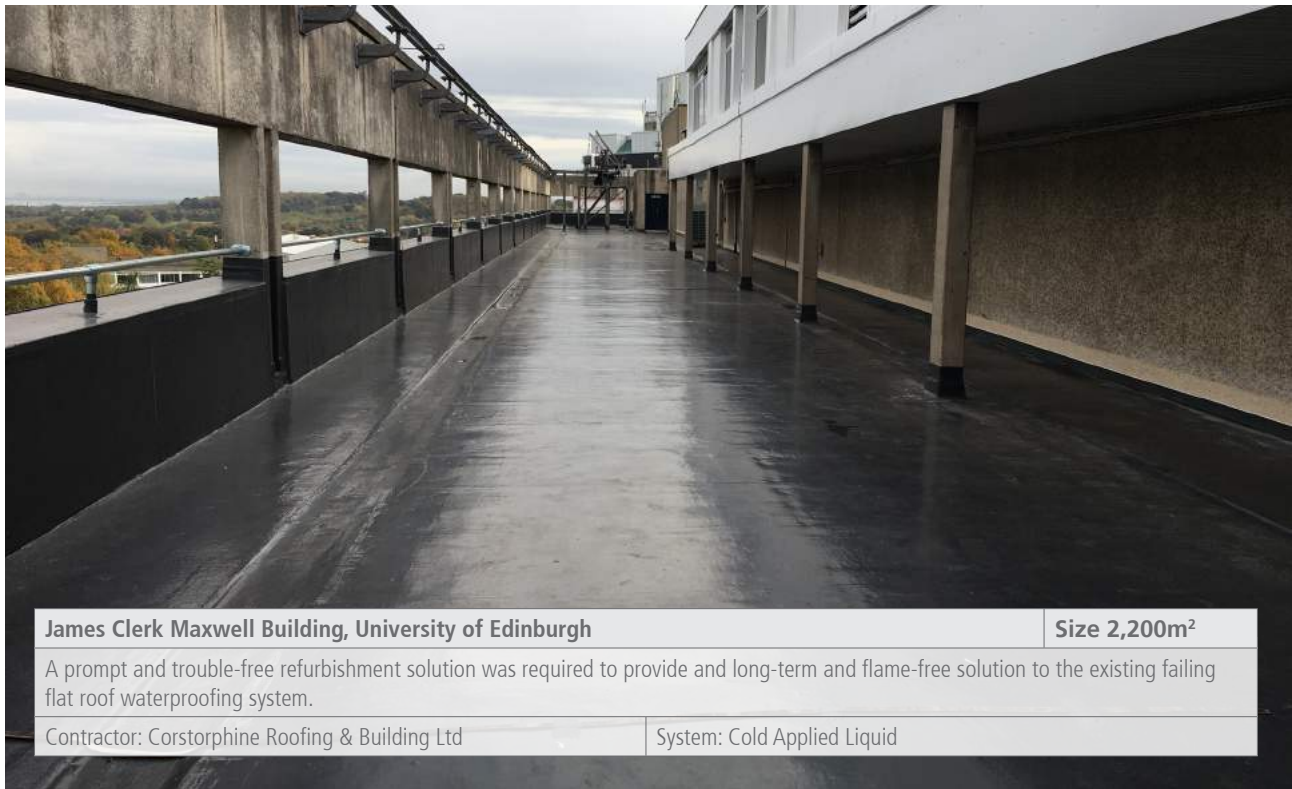

James Clerk Maxwell Building, University of Edinburgh	Size 2,200m²
--	--------------------------------

A prompt and trouble-free refurbishment solution was required to provide a long-term and flame-free solution to the existing failing flat roof waterproofing system.

Contractor: Corstorphine Roofing & Building Ltd	System: Cold Applied Liquid
---	-----------------------------

IKO polimar EC/UV
Liquid Applied Waterproofing



Parsons Green Primary School, Edinburgh	Size 1,200m²
--	--------------------------------

Built in 1961, the school had a copper pitched roof needing replacing, and an upgrade to the insulation of the building. As the school is located in a conservation area, it was vital that the replacement roof was a similar colour to the existing, copper green one.

Contractor: Braedale Roofing, Wishaw	System: Cold Applied Liquid
--------------------------------------	-----------------------------

 ikogroup.co.uk/case-studies



Rosebery Square East Residential Flats, Clerkenwell, London	Size 900m²
IKO Polimar FCS Walkway System was installed to replace the failing material on top of the mastic asphalt substrate. Because IKO Polimar FCS is fast-curing, it has enabled traffic by the residents to be acceptable within minutes of being applied.	
Contractor: Capital Roofing	System: Cold Applied Liquid

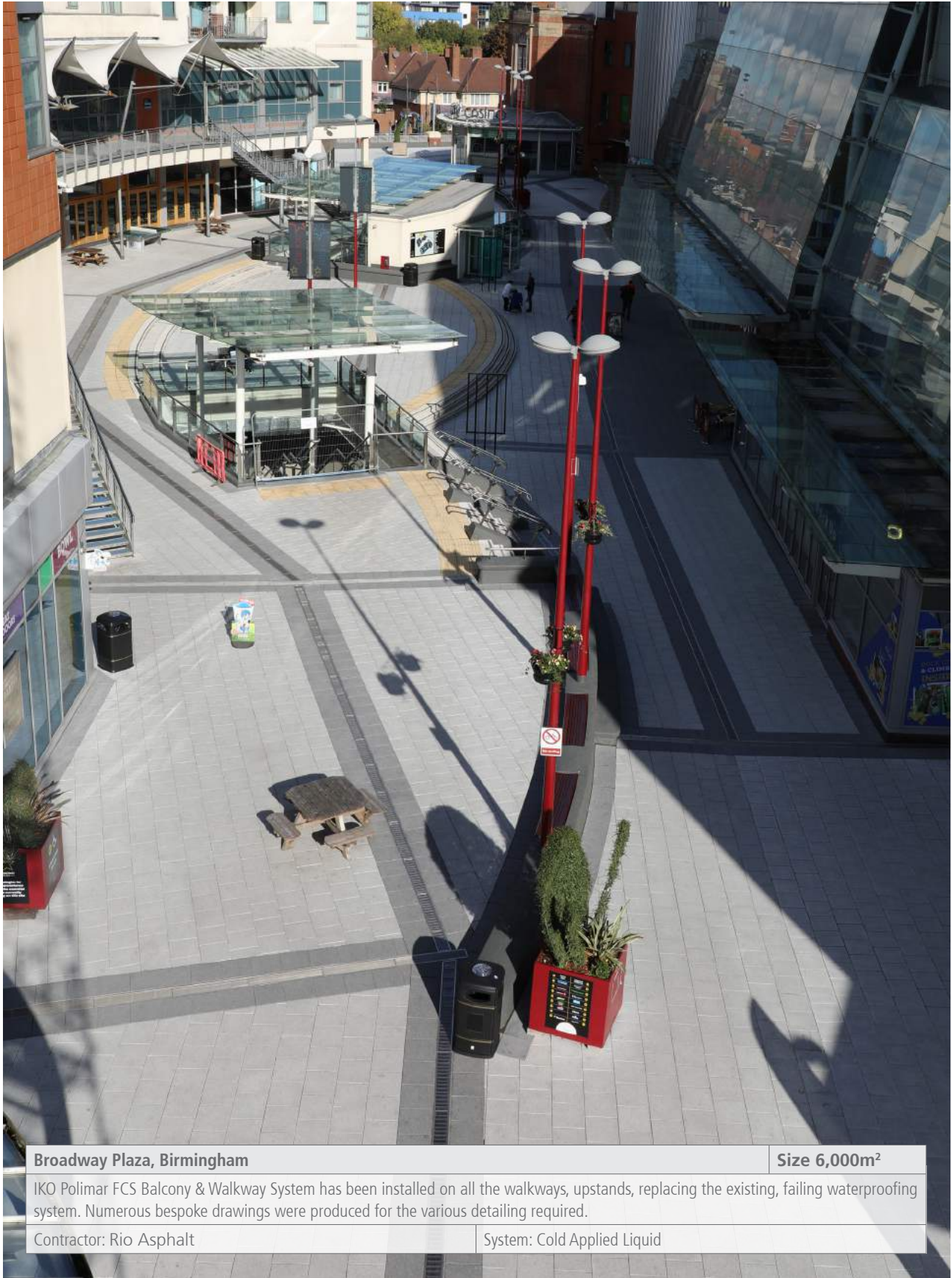

Broadway Plaza, Birmingham

Size 6,000m²

IKO Polimar FCS Balcony & Walkway System has been installed on all the walkways, upstands, replacing the existing, failing waterproofing system. Numerous bespoke drawings were produced for the various detailing required.

Contractor: Rio Asphalt

System: Cold Applied Liquid



ikogroup.co.uk/case-studies

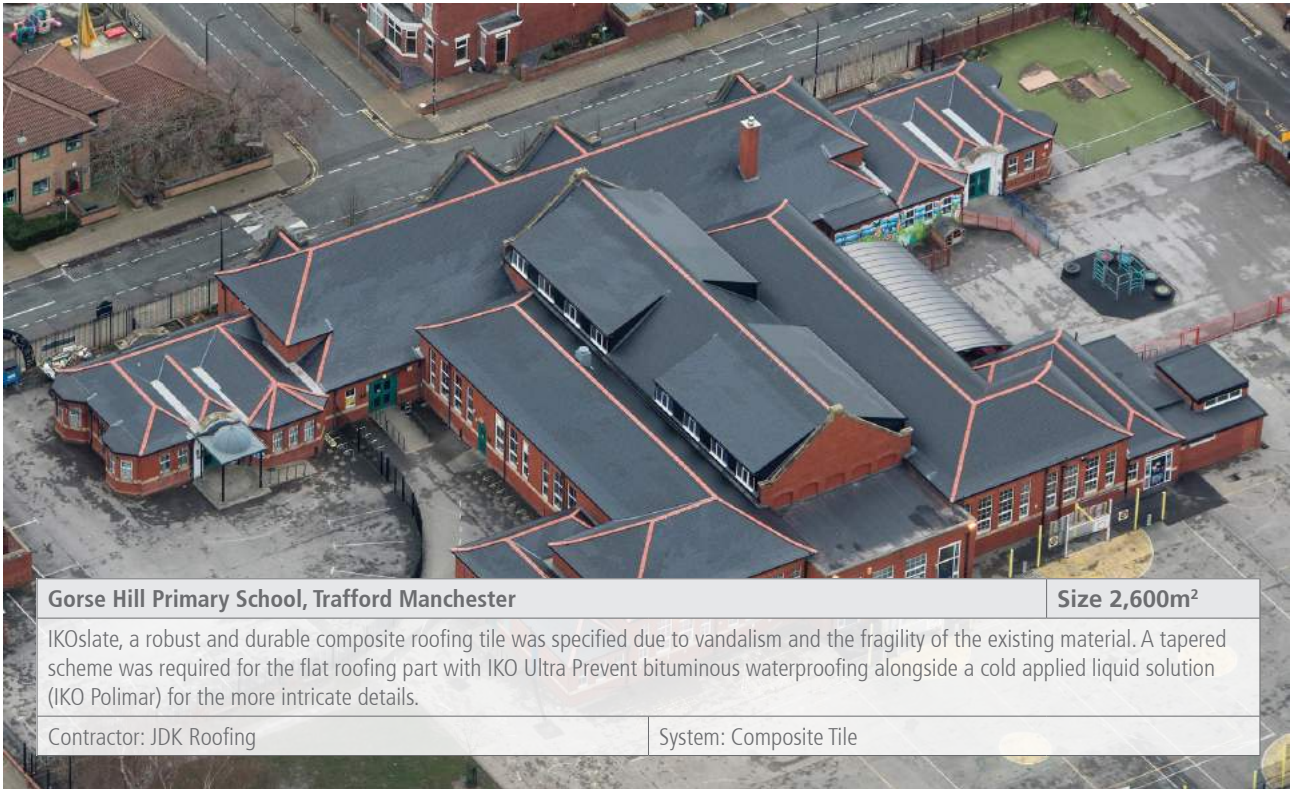

Gorse Hill Primary School, Trafford Manchester	Size 2,600m²
IKOslate, a robust and durable composite roofing tile was specified due to vandalism and the fragility of the existing material. A tapered scheme was required for the flat roofing part with IKO Ultra Prevent bituminous waterproofing alongside a cold applied liquid solution (IKO Polimar) for the more intricate details.	
Contractor: JDK Roofing	System: Composite Tile

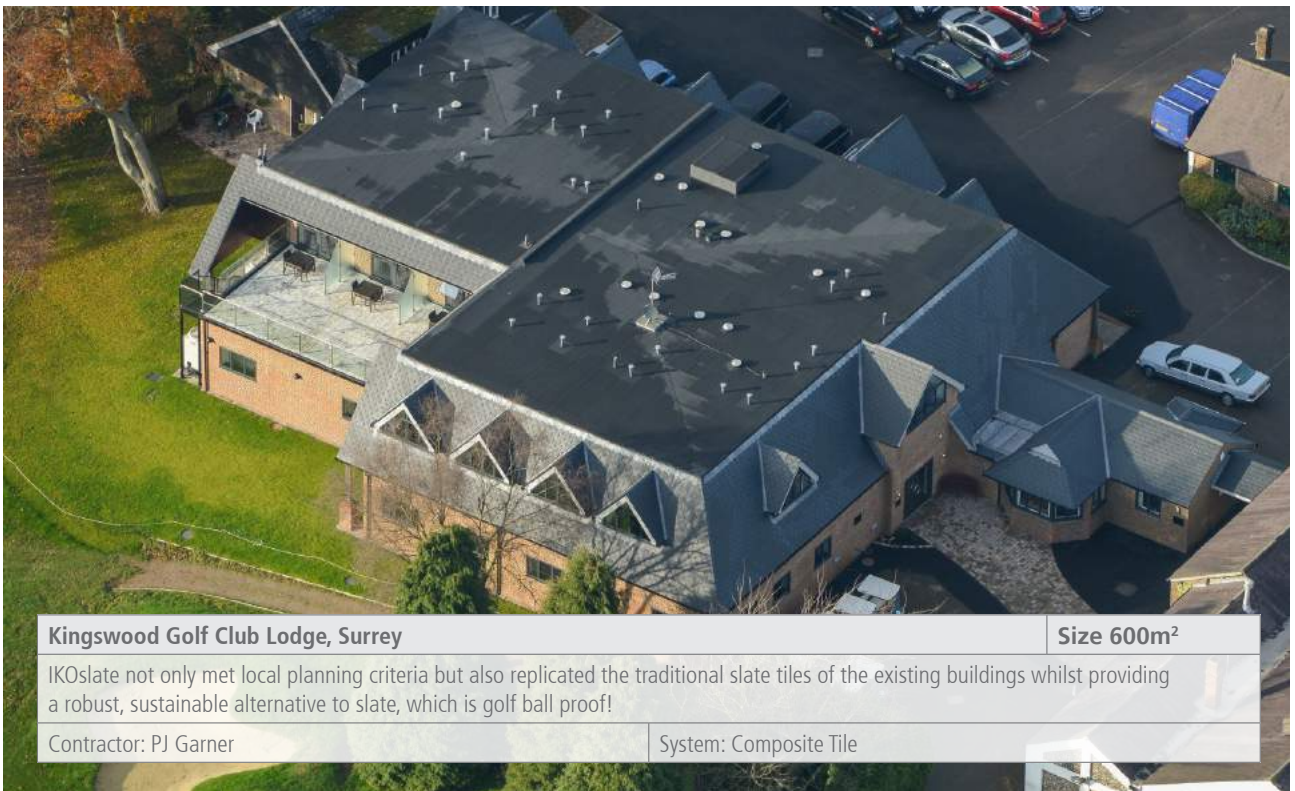

Kingswood Golf Club Lodge, Surrey	Size 600m²
IKOslate not only met local planning criteria but also replicated the traditional slate tiles of the existing buildings whilst providing a robust, sustainable alternative to slate, which is golf ball proof!	
Contractor: PJ Garner	System: Composite Tile



Priory Academies, Lincoln

Over 50,000 tiles

IKO Metrotile was specified because of its unmatched material durability and security, yet could be installed rapidly.

Contractor: Dodds Roofing

System: Light Steel Sheeting



Southport College Science Block, Southport

Southport College has maintained a program of roof maintenance, converting their flat roofs to pitched using IKO Metrotile. Because IKO Metrotile is up to 7 times lighter than traditional roofing materials, this system provides a low-maintenance solution for the future life of the structure.

Contractor: Alpha Roofing

System: Light Steel Sheeting



ikogroup.co.uk/case-studies

Our Values

There are 6 main IKO Values that are core to the business (Sharing Knowledge, Integrity, Long-Term, Performance, Humility and Agility), helping define IKO's history and provide the blueprint for what IKO can achieve both today and in the future.



www.ikogroup.co.uk/about-iko/iko-values

IKO in the UK

The IKO UK Group, comprising IKO PLC and IKO Polymeric, was established in 2000 and has grown both organically and through the successful acquisition and integration of well known, reputable brands including Ruberoid, Permanite, Marley Waterproofing, Hyload and Pure Asphalt.

IKO PLC continues to grow within the traditional roofing and waterproofing industry as well as a number of different markets including PIR insulation and mastic asphalt solutions for highways and civil engineering projects.

For over 130 years IKO PLC has been providing the design, manufacture and installation of roofing, waterproofing and insulation systems, yet still has commitment to continue investing in products solutions, manufacturing facilities and it's employees, all dedicated to achieving excellence at every level.

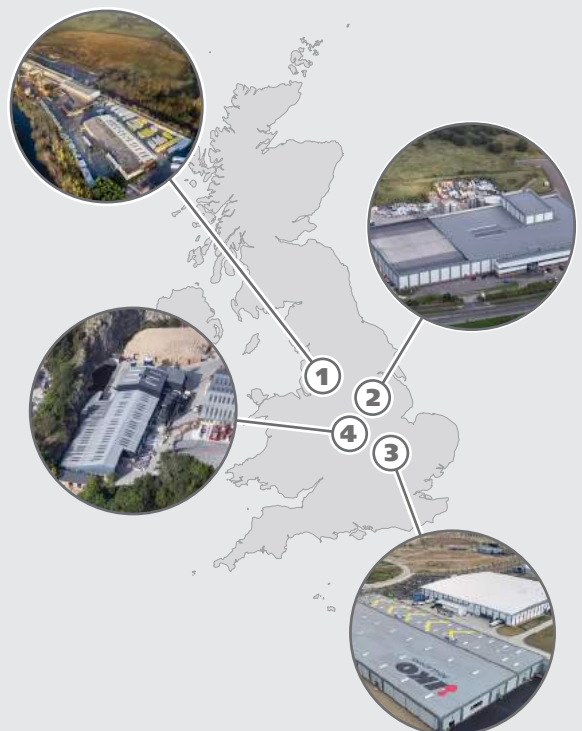

①	IKO PLC, Head Office, Wigan, Lancashire - Bituminous Membrane & Liquid
②	IKO Polymeric, Clay Cross, Chesterfield - Single Ply, High Performance DPC
③	Alconbury Weald, Cambridgeshire - PIR Insulation
④	Grangemill Quarry, Matlock, Derbyshire - Mastic Asphalt & Hot Melt



IKO PLC

Appley Lane North
Appley Bridge
Wigan
Lancashire WN6 9AB
www.ikogroup.co.uk

Member of the IKO Group

November 2018

Sales Support

t: 01257 256 865
f: 01257 251 855
sales.uk@iko.com

Technical Services

t: 01257 256 864
f: 01257 252 514
technical.uk@iko.com

Whilst every care is taken to see that the information given in this literature is correct and up to date it is not intended to form part of any contract or give rise to any collateral liability, which is hereby specifically excluded. Intending purchasers of our materials should therefore verify with the company whether any changes in our specification or application details or otherwise have taken place since this literature was issued.

