

## The Complete SmartVerge™ Dry Verge Range

### Handed PVCu Dry Verge - System Components:

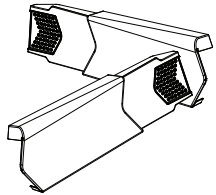

**GDV SmartVerge**  
(PVCu Handed)

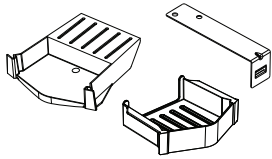

**Eaves Closure Unit(s)**  
(GDV-EC / REC)  
**Batten End Clip**  
(GDV-BEC)

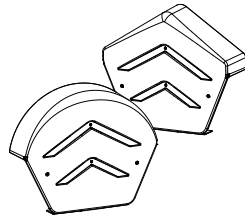

**Ridge End Caps**  
(GDV-END-A / R)

### Other Dry Verge Systems Available:

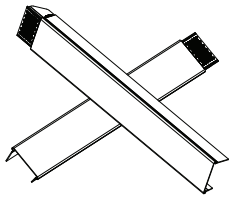

**GLV Linear Verge**  
(PVCu Handed)

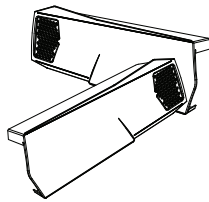

**GPPV-RH / LH Units**  
(PP Handed)

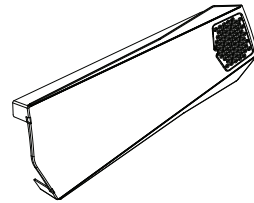

**GPPV-AMBI SmartVerge**  
(PP Ambidextrous)

### Verge Hands

Careful attention should be taken when specifying 'Right' & 'Left'.



**Right Hand Verge**



**Left Hand Verge**

Other products from the Manthorpe Range include Cavity Trays, Cavity Closer, Loft Doors, Access Panels, Roof Ventilation, Through Wall Ventilation, Drainage Channels, Dry Fix Roofing and Air Leakage Products.



### Manthorpe Building Products Limited

Manthorpe House, Brittain Drive, Codnor Gate Business Park, Ripley, Derbyshire DE5 3ND

T: (01773) 303 000 F: (01773) 303 300 E: [mbp.care@manthorpebp.co.uk](mailto:mbp.care@manthorpebp.co.uk)

W: <http://www.manthorpebp.co.uk>

# Manthorpe

## SmartVerge™

PVCu

## Dry Verge System

Fitting Instructions

MBP-0563-00-F

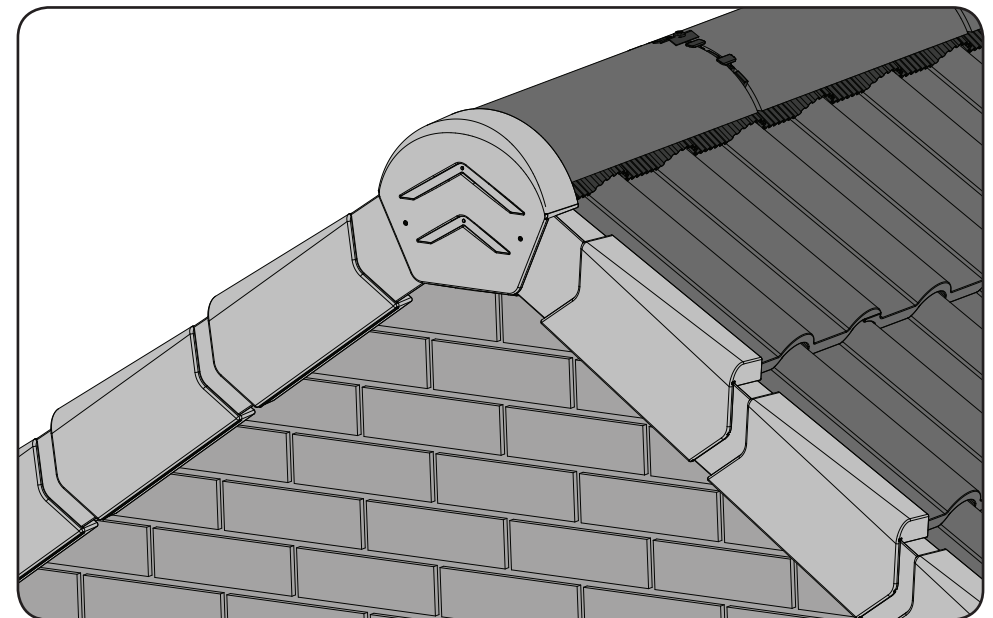

## SmartVerge™ PVCu Handed Dry Verge - Installation Requirements:

The dry fix verge system is designed to work with concrete interlocking roof tiles, see below for key product details:

- **Tile Size Format:** Large format interlocking (approx. 418 x 330mm)
- **Batten Gauge Range:** 280mm - 345mm
- **Roof Pitch Range:** 15° - 55°

## Preparation

**NOTE** The mounting face of the timber, to which the verge units are fixed, should overhang the finished face of the gable wall by at least **30mm**.

### Mounting Option A - End of Batten Fixing

Saw the tiling battens off square so that they overhang the gable wall or bargeboard by at least **30mm**. The top course of tiling battens should be distanced no further than 85mm down from the apex.

Securing a verge unit into the batten end can be achieved with either a nail or screw fixing, however to meet the British Standards for dry fix roofing elements and achieve a robust fixing it is recommended that a Batten End Clip (GDV-BEC) is used when fixing into the end grain of a tiling batten with a nail. If using a screw fixing, the verge units can be fixed directly into the batten end grain.

See installation step 3 for recommended fixings.

To install the Batten End Clip, place one clip centrally about each tiling batten, ensuring the mounting face is square against the cut end. Fix the clip in position through the two top holes using 25 x 3.35mm aluminium clout nails.

### Mounting Option B - Counter Batten Fixing

In some details (for example refurbishment details where the batten ends are damaged) using a counter batten fixing method may be more appropriate.

Run a counter batten up the length of the verge allowing at least **30mm** overhang from the face of the batten over the wall or bargeboard. This batten should be securely fixed to tiling battens, bargeboard or wall, the specific fixing method will depend on the detail.

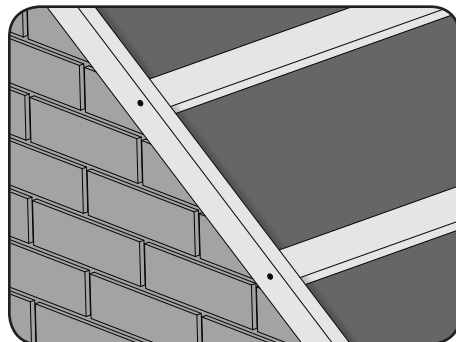
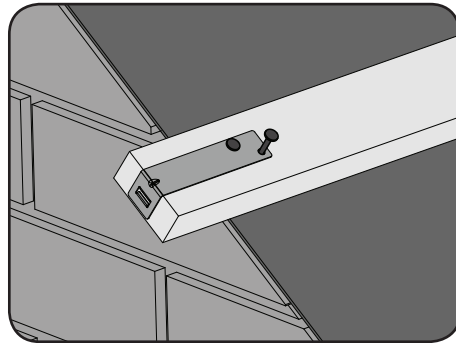
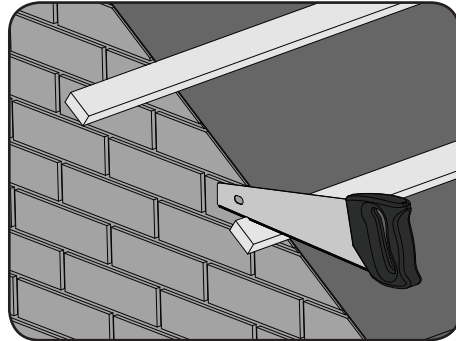

## Installation

1. To align the eaves closure unit, clip into a verge unit and position over the first eaves tile. Mark the closure position, then remove from the verge unit. Screw the unit in place using the fixings provided into a suitable timber structure, or with a plug into the masonry. *When using a counter batten, the closure can be sandwiched between the gable and mounting batten for additional security.*

2. With the eaves closure mounted, 'flex' open the first dry verge unit and position over the closure, pushing it over the unit until both sides of the clip engage with the outer fins of the eaves closure.

**IMPORTANT:** The eaves verge unit must be securely fixed at both the nose and tail of the unit.

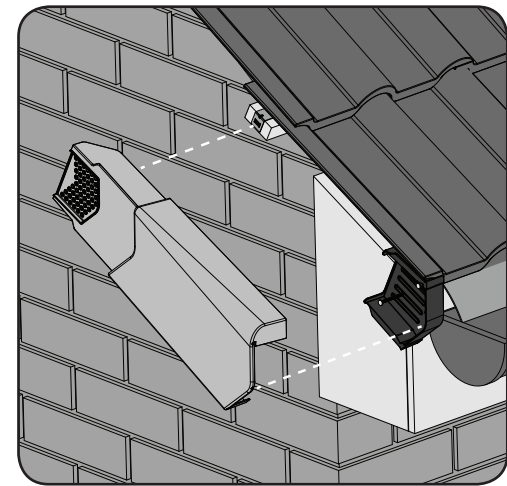
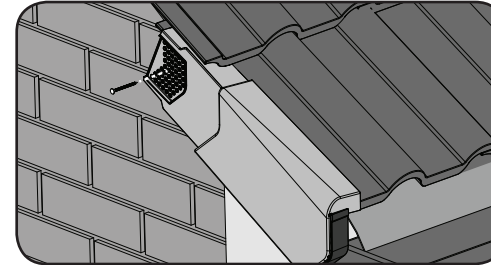

3. Slide the verge unit toward the apex until it sits squarely against the tile with nail plate in line with the tiling batten. Select the appropriate hole so that the fixing aligns with either the slot on the Batten End Clip or falls along the centre of the batten. Securely fix the unit in place using a stainless steel fixing; either a 3.35mm x 38mm annular shank nail or no. 8 x 38mm pan head woodscrew.

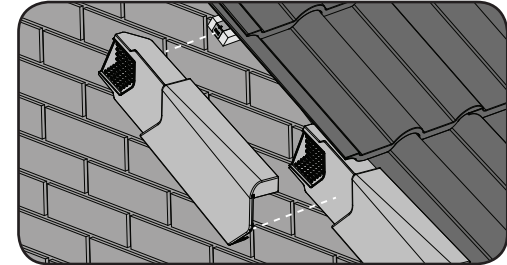

4. Hook the second verge unit over the tail of the first so the top clip engages with the fins on the first unit, 'flex' the bottom clip over the lower fin until it clicks into position. Ensure both clips are engaged before sliding the verge unit upward, ensuring that it sits squarely against the tile before fixing it into position through the appropriate fixing hole into the Batten End Clip or mounting batten.

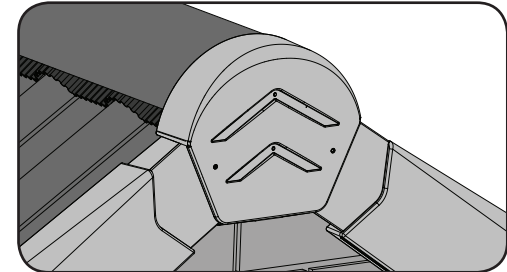
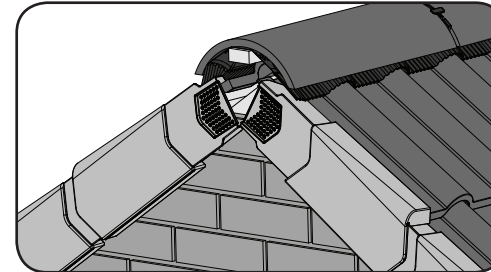

5. Repeat this process up the run of the verge until you reach the apex and each course of tiles has been capped. Repeat steps 1 through 5 on the opposing hand of the verge, taking care to use the appropriate hand of verge unit for that side of the verge where necessary.

6. Align the Ridge End Cap with the top verge units and flex it over the ridge tile ensuring that the verge unit fins are securely located within the slots on the end cap. Using the screws provided, fix the end cap in place into the end of the ridge batten, top tiling/mounting battens, barge board or masonry.