

Pocket Guide 2023



BMI

Redland

Guide to our complete
pitched roofing solutions

bmigroup.com/uk



From concrete slate-appearance tiles, concrete profiled tiles, recycled natural slate Cambrian Slates, or plain tiles made in concrete and clay, we have a comprehensive range of roofing solutions carefully designed, tested and manufactured to give value, visual appeal and long-lasting weatherproof performance.

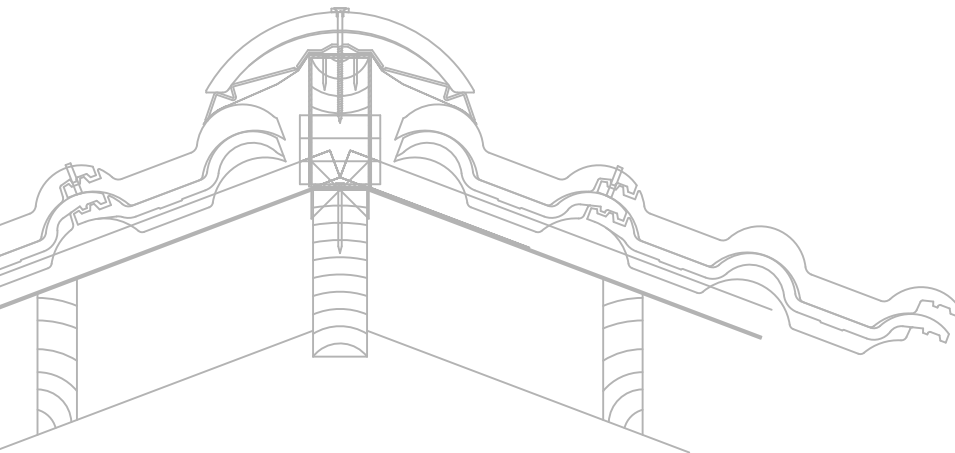

Contents

ABOUT BMI UK & IRELAND	4-5
SHAPING THE PITCHED ROOFSCAPE	6
COVERING EVERY FLAT ROOFING NEED	7
A WORLD OF SUPPORT AND SERVICE	8-11
RECYCLED NATURAL SLATE	12-13
Cambrian Slate	14-17
INTERLOCKING FLAT TILE RANGE	18-19
Saxon 10 Slate	20-23
Richmond 10 Slate	24-27
MockBond Richmond 10	28-31
Mini Stonewold	32-35
MockBond Mini Stonewold	36-39
PLAIN TILE RANGE	40-41
Rosemary Clay Craftsman	42-45
Rosemary Clay Classic	46-49
Heathland	50-53
Plain Tile	54-59
DuoPlain	60-63
PROFILE TILE RANGE	64-65
Grovebury	66-69
50 Double Roman	70-73
Regent	74-77
Renown	78-81
Redland 49 (Imperial size)	82-85
Fenland Pantile (Imperial size)	86-89
SYSTEM ACCESSORIES	90-91
PV InDaX Adapt	92-93
Fittings	94-97
Underlay	98-101
Eaves Systems	102-105
Verge Systems	106-113
Hip Systems	114-117
Ridge Systems	118-125
Valley Systems	126-129
Abutment Systems	130-135
Ventilation Products	136-147
Accessories	148-156

BMI UK & Ireland

A combination of Icopal and Redland, BMI is the UK and Ireland's leading solutions provider and manufacturer of both flat and pitched roofing, as well as other building membranes, making us uniquely placed to support any building's needs.



BMI is a new name, backed-up with over 180 years of experience and knowledge. Bringing together the roofing expertise of industry-leading Redland and Icopal and their experience in the manufacture, specification and supply of pitched and flat roofing solutions as well as other building membranes. United to deliver excellence for our customers.

Meeting your needs: complete system solutions

Our market-leading brands cover every roofing technology, so we can recommend the best solution for our customers' needs.

Our philosophy is to look beyond just roofing products. Individually, our products offer exceptional performance. Working together, they offer unrivaled reliability and excellence.

That's why we are committed to developing complete and integrated systems which combine technologies, products, components and accessories with specialist support, services, training and guarantees.

Construction products for the roof and beyond

Our range of construction products, includes Acoustic Systems, Tanking, Structural Waterproofing and Ground Contamination solutions, Scaffold Sheeting and Specialist Protective Sheeting.



ACOUSTIC SYSTEMS

Offering unrivalled sound reduction for walls and floors with a range of acoustic floors and unique flanking systems.

TEMPORARY ROOF COVERINGS

Developed in collaboration with major contractors, our temporary roof covering range ensures work can continue in all weather conditions.



STRUCTURAL WATERPROOFING

Structural waterproofing membranes that provide high performance protection and containment solutions.

SCAFFOLD SHEETING

Serving as a climate shield and extra security, our scaffold sheeting has been proven in use by some of the most respected names in construction



RADON, AIR & MOISTURE PROTECTION

Gas and radon barrier systems to provide flexible, high-performance solutions for both commercial and domestic applications.



Shaping the pitched roofscape

The requirement for ever higher levels of performance and aesthetic appeal have had a dramatic effect on how we build pitched roofs.

We provide full roof solutions from roof tiles and underlays to eaves systems and ridges. All elements of our roofs are carefully designed, tested and manufactured to give value, visual appeal and a longlasting weather-tight performance.



RECYCLED NATURAL SLATE

Our Cambrian Slates embody the character of natural slate. They are made in Wales from over 60% recycled Welsh slate and are suitable for even the most exposed sites.



INTERLOCKING FLAT

Our Flat tile range delivers the simple beauty of a slated roof with precision manufacturing that ensures a durable and weathertight construction.

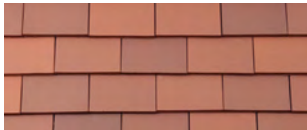

PLAIN

Our plain roof tiles combine an authentic and traditional look with strength and durability you can rely on.

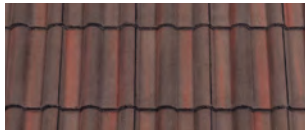

PROFILE

Our wide choice of profiled tiles come in an extensive selection of colours and finishes and are suited to almost any pitched roof design.



ACCESSORIES

We manufacture and supply all of the products needed to complete your roof systems from the ventilation to valleys, ridges and everything in-between.



PV SOLAR

Our in-roof PV system is compatible with all our tiles and utilises half-cut cell module technology to achieve cost-efficiency and high output performance.

Covering every flat roofing need

Perhaps one of the most prevalent architectural features of a modern building is the flat roof. However, while these systems have their own unique character, they also come with a unique set of requirements.

BMI has a proud heritage in waterproofing systems for flat roofing, so you can trust we'll provide a roof that protects your building against the UK's worst weather conditions.



BITUMEN

Offering high quality systems suitable for a wide range of surfaces - from traditional membranes and underlays, to innovative flame retardant solutions. Our bitumen offer also includes hot melt solutions.



GREEN ROOFS

Benefit the environment through their positive impact on sustainability, biodiversity and the attenuation of storm water, whilst enhancing the landscape.



LIQUID WATERPROOFING

Our liquid waterproofing range of products are extremely versatile and can be used for flat roof applications of all shapes and sizes, ranging from small to large projects.



COMPLETE SYSTEMS

Full system accessories, fixtures and fittings are available to support all of our flat roofing systems, including insulation, rooflights and roofglazing.



SINGLE PLY

Achieve a high-performing, lightweight, flexible roofing system with excellent thermal insulation – to reduce a building's carbon footprint.

Pitched roofing support and service

A roof is never just a roof.

While our roofs are there to protect what matters below, we are here to look after everything that matters around them. Just as our systems are never just about products, nor is our support just about the roof itself. Instead, it's built around a number of factors: dedicated training, a greater choice of guarantees, full project, technical and local support.

Our 5-step process outlines how we achieve this with you:

- Consultation and survey
- Design and specification
- Legislative compliance
- Project compliance
- System guarantee

Whether you require just telephone advice for your project or want to benefit from our complete specification service, our expert team are on hand to help ensure success for your roof.



Technical tools and services

As well as an unrivalled range of materials, components and systems, BMI Redland has developed a comprehensive range of free technical services to save you time and provide complete peace of mind in your roofing project.



BIM

A library of BIM objectives to provide design support and extensive product information.



FIXMASTER

Online fixing specification service tailored to every pitched roofing project.



SPECMASTER

Complete guaranteed pitched roof specification service with NBS-based clauses.



ECOMASTER

Specification service for projects using solar photovoltaic systems.



DESIGNMASTER

Comprehensive CAD library of over 4,000 quality roofing drawings.



PROJECT SPEC

The full range available in the NBS library of building product details, linked to clause guidance.



QUANTMASTER

Our pitched roof materials quantity estimating service.



SAMPLES

Request a selection of roof tile samples for your project.

Speak to a member of our Technical Services team on 0330 123 4585

Specifications made easy

When you contact the BMI Redland Technical Services team, you can expect personal, expert attention for your project.



15 YEAR REDLAND WHOLE ROOF GUARANTEE

Our free-of-charge SpecMaster service provides you with a bespoke roof specification and guarantee for your project.

A SpecMaster specification covers every detail of the roof and covers everything from performance specifications to British Standards compliance. We even supply the required Redland product codes and a material list to make ordering easier.

The specification is also in NBS-based format, so it can be easily incorporated into your formalised project specification.

With SpecMaster, not only can you be sure that your roofing specification is the best it can be, but if you follow the BMI Redland roof system specification, you also have the added reassurance of our comprehensive 15-year design liability and roof weathertightness guarantee.

bmigroup.com/uk/specmaster



FIXMASTER

Our efficient free-of-charge FixMaster service speeds up the fixing specification process, allowing users to determine the correct fixings - and the safety of the roof - in just seven simple steps.

Our simple-to-use service ensures that your chosen pitched roof fixings are fully compliant with British Standards, calculating fixing specifications to BS 5534 to provide full peace of mind.



Safe, High Performing Pitched Roof Fixings for Your Project.

Not only does FixMaster ensure the highest safety and quality standards are delivered, but our roof tile fixing specification tool also takes all relevant factors into account - from roof and tile-type to geometry, location and exposure - providing you with a reference document to be used for on-site supervision and checks before each property is signed-off.

bmigroup.com/uk/fixmaster

Recycled Natural Slate

Responsibly rescuing natural Welsh slate waste and recycling it into a new solution, Cambrian is an alternative that delivers greater performance as well as aesthetics.

It's a complete system engineered to be faster and easier to install to a beautiful finish, for any skill level. And our Cambrian Slate system benefits from the complete support and comprehensive guarantees of BMI Redland. This tile brings the best of old and new – of slate and sustainability, of natural and synthetic, of looks and performance – into one package, for complete simplicity.



RECYCLED NATURAL SLATE

Cambrian Slate

Page no.	14-17
Min. pitch	15°
Weight*	17kg/m ²
Cover*	13.3 slates/m ²

* Laid weight and cover at correct batten gauge

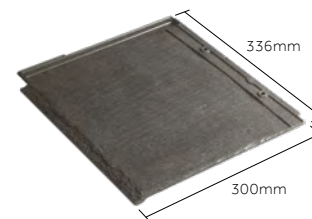

Heather

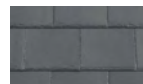

Slate Grey



Slate Grey
(Pre-Weathered)



Cambrian Slate

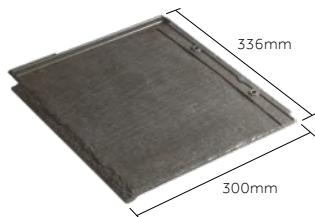

KEY FEATURES AND ADVANTAGES

- Engineered using reclaimed natural Welsh slate
- Interlocking: Simple to install and fix
- Low maintenance and 60-year product guarantee
- Awarded BBA certification: 87/1907

PRODUCT DETAILS

Size	300 x 336mm	
Minimum pitch and headlap	15° at 75mm headlap/ 25° at 50mm headlap (The minimum pitch is based on a maximum rafter length of 10 metres. For rafter lengths greater than this and/or the presence of roof windows please contact Technical Services on 0330 123 4585)	
Maximum pitch (subject to fire resistance requirements above 69 deg)	90°	
Maximum headlap	90mm	
Minimum gauge/batten spacing	210mm	
Maximum gauge/batten spacing	below 25° 225mm/25° and over 250mm	
Hanging length (approx)	294mm	
Cover (all figures are net and do not allow for wastage)		
Linear cover of 1 slate	300mm	
Covering capacity	14.8 slates/m ² at 225mm gauge / 13.3 slates/m ² at 250mm gauge	
Weight	18kg/m ² at 225mm gauge / 17kg/m ² at 250mm gauge	
per pallet, including pallet (approx.)	0.76 tonnes	
per 1000	1.24 tonnes	
Battens required (at max. gauge)	4.0m/m ²	
Batten size		
Rafter centres up to 450mm	38 x 25mm	
Rafter centres up to 600mm	50 x 25mm	
Fixing clips	Eaves, verge & slate clips	
Nail size for slates*	30 x 2.65mm (S/S)	
Pallet quantities	Slates per pallet 600 / slates per pack 10 / packs per pallet 60	

* (S/S) Stainless Steel Annular ring shanked

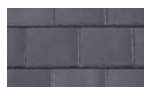

Heather

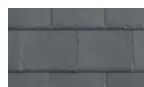

Slate Grey



Slate Grey
(Pre-Weathered)



CAMBRIAN SLATE

SLATE

PRODUCT CODES

TILES	Previous code	Code
Standard Slate Heather	470128	10001758
Standard Slate Slate Grey	470130	10001760
Standard Slate Slate Grey Pre-Weathered	470131	10001761
Cambrian Slate-and-a-Half Heather	470228	10001762
Cambrian Slate-and-a-Half Slate Grey	470230	10001764
Cambrian Slate-and-a-Half Slate Grey Pre-Weathered	470231	10001765
Cambrian Left-hand Verge Slate Heather	470328	10001766
Cambrian Left-hand Verge Slate Slate Grey	470330	10001768
Cambrian Left-hand Verge Slate Slate Grey Pre-Weathered	470331	10001769
Cambrian Left-hand Verge Slate-and-a-Half Heather	470428	10001770
Cambrian Left-hand Verge Slate-and-a-Half Slate Grey	470430	10001772
Cambrian Left-hand Verge Slate-and-a-Half Slate Grey Pre-Weathered	470431	10001773
Cambrian Double Slate Heather	470528	10001774
Cambrian Double Slate Slate Grey	470530	10001776
Cambrian Double Slate Slate Grey Pre-Weathered	470531	10001777
UNDERLAYS		
Divoroll Elite 200 2S	915700	10002797
Divoroll Universal 2S	915600	10002796
EAVES PRODUCTS		
Rapid EavesVent 2-in-1 Tray	998800	20001276
Rapid EavesVent Rafter Roll (6m)	998400	20001275
RedVent 25 Over-Fascia Vent (6m)	959300	20001230
Underlay Support Tray (1.5m)	907600	20001461

Fittings and components continued >

FITTINGS AND COMPONENTS

VERGE PRODUCTS	Previous code	Code
Cambrian Ambi-DryVerge II (10) Slate Grey	948800	10002828
Cambrian Ambi-Dry II Eaves/Ridge Slate Grey	949100	10002829
HIP PRODUCTS		
Cambrian Mitred Hip (10 courses)	950400	20001206
Continuous Hip (5m)	950300	20001205
Uni-Vent Rapid Ridge/Hip (10m)	931300	10002813
Uni-Vent Rapid Hip Support Tray (10 x 1.2m)	906900	20001084
Universal Angle Hip/Ridge Junction	952000	20001211
Universal Angle Hip (without nail holes) Slate Grey	777730	10002352
Universal Angle Hip (without nail holes) Black	777763	10002355
Universal Angle Hip (without nail holes) Terracotta	777734	10002353
Universal Angle Hip (with nail holes) Slate Grey	777830	10002358
Universal Angle Hip (with nail holes) Black	777863	10002361
Universal Angle Hip (with nail holes) Terracotta	777834	10002359
Universal Angle Block-End Hip Slate Grey	777930	10002364
Universal Angle Block-End Hip Black	777963	10002367
Universal Angle Block-End Hip Terracotta	777934	10002365
Hip End Cap Universal Angle Terracotta	970434	10002848
Hip End Cap Universal Angle Black	970463	10002849
Mortar Bedded Fixing Kit	931400	10002814
VALLEY PRODUCTS		
Cambrian GRP Valley (3m)	955300	20001218
ABUTMENT PRODUCTS		
Top Edge Abutment Ventilation (3m)	954800	10002838
Wakaflex Rapid Flashing (see pages 148-149)		
Abutment GRP Secret Gutter (3m)	959600	20001232
Bonding Strip (Low Profile) (3m)	958000	20001227
Bonding Strip (High Profile) (3m)	957800	20001226
RIDGE PRODUCTS		
DryVent Ridge (2.7m)	905900	10002748
Uni-Vent Rapid Ridge/Hip (10m)	931300	10002813
Continuous Ridge (5m)	930800	10002811

Cambrian Slate

RIDGE PRODUCTS CONTINUED	Previous code	Code
Universal Angle Ridge Slate Grey	714630	10002040
Universal Angle Ridge Black	714663	10002043
Universal Angle Ridge Terracotta	714634	10002041
Hi-Pitch Universal Angle Ridge Slate Grey	715130	10002052
Hi-Pitch Universal Angle Ridge Terracotta	715134	10002053
Universal Angle Block-End Ridge Slate Grey	751830	10002238
Universal Angle Block-End Ridge Black	751863	10002241
Universal Angle Block-End Ridge Terracotta	751834	10002239
DryVent Monoridge (2.7m)	908400	10002753
Universal Angle Monoridge Slate Grey	714830	10002046
Universal Angle Monoridge Black	714863	10002049
Universal Angle Monoridge Terracotta	714834	10002047
Universal Angle Monoridge End Cap LH Slate Grey	977830	20001388
Universal Angle Monoridge End Cap LH Rust	977855	20001389
Universal Angle Monoridge End Cap RH Slate Grey	977930	20001390
Universal Angle Monoridge End Cap RH Rust	977955	20001391
Mortar Bedded Fixing Kit	931400	10002814
Universal Angle Ridge End Cap Slate Grey	977330	20001254
Universal Angle Ridge End Cap Terracotta	977334	20001255
Universal Angle Ridge End Cap Rust	977355	20001256
Universal Angle Ridge End Cap Black	977363	20001257
Cambrian Ambi-Dry II Eaves/Ridge	949100	10002829
VENTILATION TILES		
4.5k ThruVent Tile Heather	770528	10002317
4.5k ThruVent Tile Slate Grey	770530	10002319
4.5k ThruVent Tile Slate Grey Pre-Weathered	770531	10002320
Flexible Pipe (75 to 100mm)	918800	20001156
FIXING		
Eaves Clip and nails (50 clips + 50 nails)	919200	20001395
Slate Clip and nails (100 clips + 210 nails)	919600	20001397
Verge Clip and nails (20 clips + 40 nails)	919300	20001396
OTHER ACCESSORIES		
Slate Replacement Kit (5 Slate Kit)	955400	20001219

Interlocking Flat Tile Range

In this range you will find our concrete solutions that have been designed to deliver the appeal of a slate-appearance roof with precision manufacturing that ensures a durable, weathertight construction.

The Interlocking Flat Tile range offers an economical and efficient solution, along with high performance.



Saxon 10 Slate

Page no.	20-23
Min. pitch	17.5°
Weight*	47kg/m ²
Cover*	9.7 slates/m ²



Richmond 10 Slate



MockBond Richmond 10

Page no.	24-27	28-31
Min. pitch	17.5°	17.5°
Weight*	47kg/m ²	47kg/m ²
Cover*	9.7 slates/m ²	9.7 slates/m ²



Mini Stonewold

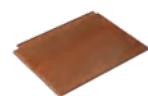

MockBond Mini Stonewold

Page no.	32-35	36-39
Min. pitch	17.5°	17.5°
Weight*	51kg/m ²	51kg/m ²
Cover*	9.9 slates/m ²	9.9 slates/m ²

* Depends on headlap used. Refer to product pages for full technical information.

Saxon 10 Slate

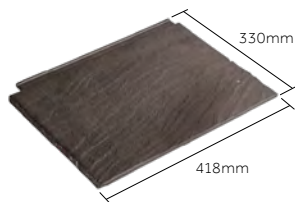

KEY FEATURES AND ADVANTAGES

- Riven surface, chamfered side edges
- Thin front edge replicates features of natural products

PRODUCT DETAILS

Size	418 x 330mm	
Minimum pitch and headlap	17.5° at 100mm headlap / 22.5° at 75mm headlap (The minimum pitch is based on a maximum rafter length of 10 metres. For rafter lengths greater than this, please contact Technical Services on 0330 123 4585)	
Maximum pitch (subject to fixing specification and fire resistance requirements above 69°)	90°	
Maximum headlap	125mm	
Minimum gauge/batten spacing	293mm	
Maximum gauge/batten spacing	below 22.5° 318mm / 22.5° and over 343mm	
Hanging length (approx)	395mm	
Cover (all figures are net and do not allow for wastage)		
Linear cover of 1 slate	300mm	
Covering capacity	10.5 slates/m ² at 318mm gauge / 9.7 slates/m ² at 343mm gauge	
Weight	51kg/m ² at 318mm gauge / 47kg/m ² at 343mm gauge	
per pallet, including pallet (approx.)	1.07 tonnes	
per 1000	4.81 tonnes	
Battens required (at max. gauge)	2.92m/m ²	
Batten size		
Rafter centres up to 450mm	38 x 25mm	
Rafter centres up to 600mm	50 x 25mm	
Fixing clips	Eaves, verge & slate clips	
Nail size for slates*	45 x 3mm (A/A) 45 x 3.35mm (S/S)	
Pallet quantities	Slates per pallet 210 / slates per pack 35 / packs per pallet 6	

* (S/S) Stainless Steel Annular ring shanked (A/A) Aluminium Alloy



Black
(coated)



PRODUCT CODES

SLATE	Previous code	Code
Saxon 10 Slate Black	499163	10001793
Half Slate Pair Black	499263	10001796
UNDERLAYS		
Divoroll Elite 200 2S	915700	10002797
Divoroll Universal 2S	915600	10002796
EAVES PRODUCTS		
Rapid EavesVent 2-in-1 Tray	998800	20001276
Rapid EavesVent Rafter Roll (6m)	998400	20001275
RedVent 25 Over-Fascia Vent (6m)	959300	20001230
Underlay Support Tray (1.5m)	907600	20001461
VERGE PRODUCTS		
DryVerge (Pack of 18 LH & 18 RH) Charcoal Grey	939277	20001189
DryVerge Gable End Pack Charcoal Grey	988277	10002875
Rapid DryVerge (Pack of 18 LH & 18 RH) Charcoal Grey	939377	10002826
Rapid DryVerge Gable End Pack Charcoal Grey	988377	10002878
HIP PRODUCTS		
Continuous Hip (5m)	952400	20001214
Uni-Vent Rapid Ridge/Hip (10m)	931300	10002813
Uni-Vent Rapid Hip Support Tray (1.2m)	906900	20001084
Universal Angle Hip/Ridge Junction	952000	20001211
Universal Angle Hip (without nail holes) Black	777763	10002355
Universal Angle Hip (without nail holes) Charcoal Grey	777777	10002357
Universal Angle Hip (with nail holes) Black	777863	10002361
Universal Angle Hip (with nail holes) Charcoal Grey	777877	10002363
Universal Angle Block-End Hip Charcoal Grey	777977	10002369
Universal Angle Block-End Hip Black	777963	10002367
Hip End Cap Universal Angle Black	970463	10002849
Mortar Bedded Fixing Kit	931400	10002814

Fittings and components continued >



VALLEY PRODUCTS	Previous code	Code
125 GRP Valley (3m)	959500	20001231
Dry Valley (Low Profile) (3m)	957500	20001225
ABUTMENT PRODUCTS		
Top Edge Abutment Ventilation (3m)	954800	10002838
Wakaflex Rapid Flashing (see pages 148-149)		
Abutment GRP Secret Gutter (3m)	959600	20001232
Bonding Strip (Low Profile) (3m)	958000	20001227
Bonding Strip (High Profile) (3m)	957800	20001226
RIDGE PRODUCTS		
DryVent Ridge (2.7m)	905900	10002748
Uni-Vent Rapid Ridge/Hip (10m)	931300	10002813
Continuous Ridge (5m)	930800	10002811
Universal Angle Ridge Slate Grey	714630	10002040
Universal Angle Ridge Charcoal Grey	714677	10002045
Universal Angle Ridge Black	714663	10002043
Universal Angle Block-End Ridge Slate Grey	751830	10002238
Universal Angle Block-End Ridge Black	751863	10002241
Universal Angle Block-End Ridge Charcoal Grey	751877	10002243
DryVent Monoridge (2.7m)	908400	10002753
Universal Angle Monoridge Charcoal Grey	714877	10002051
Universal Angle Monoridge Black	714863	10002049
Mortar Bedded Fixing Kit	931400	10002814
Universal Angle Ridge End Cap Slate Grey	977330	20001254
Universal Angle Ridge End Cap Black	977363	20001257
VENTILATION TILES		
RedLine Vent Tile Black	914163	20001141
8.8k ThruVent Tile Black	794463	10002469
Rapid Roof Vent Tile Black	912363	10002769
Rapid Roof Vent Adaptor	979100	10002861
Flexible Pipe (100 to 100mm)	917200	20001149
FIXING		
Slate Clip (100) & Nail (100)	929400	20001400
Verge Clip (100)	948100	20001199
Eaves Clip (100)	929300	20001166
Slate Nails (Alum Alloy) (approx 1060)	933400	20001174
Slate Nails (Stainless Steel) (approx 300)	935000	20001178
Eaves Clip Nails (approx 812)	933800	20001177
Kro-Clip (50)	914200	10003245
Innofix Clip Purple (250)	-	11000229

Richmond 10 Slate

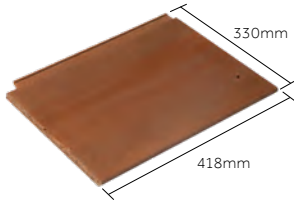

KEY FEATURES AND ADVANTAGES

- Clean, bold roof aesthetics
- Value roofing solution with no trade-off in quality
- For pitches as low as 17.5°

PRODUCT DETAILS

Size	418 x 330mm	
Minimum pitch and headlap	17.5° at 100mm headlap / 22.5° at 75mm headlap (The minimum pitch is based on a maximum rafter length of 10 metres. For rafter lengths greater than this, please contact Technical Services on 0330 123 4585)	
Maximum pitch (subject to fixing specification and fire resistance requirements above 69°)	90°	
Maximum headlap	125mm	
Minimum gauge/batten spacing	293mm	
Maximum gauge/batten spacing	below 22.5° 318mm / 22.5° and over 343mm	
Hanging length (approx)	395mm	
Cover (all figures are net and do not allow for wastage)		
Linear cover of 1 slate	300mm	
Covering capacity	10.5 slates/m ² at 318mm gauge / 9.7 slates/m ² at 343mm gauge	
Weight per pallet, including pallet (approx.) per 1000	51kg/m ² at 318mm gauge / 47kg/m ² at 343mm gauge 1.07 tonnes 4.81 tonnes	
Battens required (at max. gauge)	2.92m/m ²	
Batten size		
Rafter centres up to 450mm	38 x 25mm	
Rafter centres up to 600mm	50 x 25mm	
Fixing clips	Eaves, verge & slate clips	
Nail size for slates*	45 x 3mm (A/A) 45 x 3.35mm (S/S)	
Pallet quantities	Slates per pallet 210 / slates per pack 35 / packs per pallet 6	

* (S/S) Stainless Steel Annular ring shanked (A/A) Aluminium Alloy

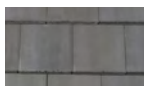

Slate Grey

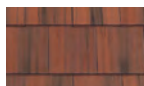

Flame Red
(coated)

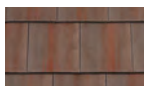

Rustic Brown
(coated)



Black
(coated)



RICHMOND 10 SLATE

CONCRETE

PRODUCT CODES

SLATE	Previous code	Code
Richmond 10 Slate Slate Grey	487130	10001778
Richmond 10 Slate Flame Red	487138	10001779
Richmond 10 Slate Black	487163	10001781
Richmond 10 Slate Rustic Brown	487140	10001780
Half Slate Pair Slate Grey	487230	10001784
Half Slate Pair Flame Red	487238	10001785
Half Slate Pair Black	487263	10001787
Half Slate Pair Rustic Brown	487240	10001786
UNDERLAYS		
Divoroll Elite 200 2S	915700	10002797
Divoroll Universal 2S	915600	10002796
EAVES PRODUCTS		
Rapid EavesVent 2-in-1 Tray	998800	20001276
Rapid EavesVent Rafter Roll (6m)	998400	20001275
RedVent 25 Over-Fascia Vent (6m)	959300	20001230
Underlay Support Tray (1.5m)	907600	20001461
VERGE PRODUCTS		
DryVerge (Pack of 18 LH & 18 RH) Charcoal Grey	939277	20001189
DryVerge (Pack of 18 LH & 18 RH) Slate Grey	939230	10003144
DryVerge (Pack of 18 LH & 18 RH) Terracotta	939234	10003145
DryVerge (Pack of 18 LH & 18 RH) Brown	939236	10003146
DryVerge Gable End Pack Charcoal Grey	988277	10002875
DryVerge Gable End Pack Slate Grey	988230	10002872
DryVerge Gable End Pack Terracotta	988234	10002873
DryVerge Gable End Pack Brown	988236	10002874
Rapid DryVerge (Pack of 18 LH & 18 RH) Slate Grey	939330	10002824
Rapid DryVerge (Pack of 18 LH & 18 RH) Rust	939355	10002825
Rapid DryVerge (Pack of 18 LH & 18 RH) Charcoal Grey	939377	10002826
Rapid DryVerge Gable End Pack Charcoal Grey	988377	10002878
Rapid DryVerge Gable End Pack Slate Grey	988330	10002876
Rapid DryVerge Gable End Pack Rust	988355	10002877

Fittings and components continued >

FITTINGS AND COMPONENTS

HIP PRODUCTS	Previous code	Code
Continuous Hip (5m)	952400	20001214
Uni-Vent Rapid Ridge/Hip (10m)	931300	10002813
Uni-Vent Rapid Hip Support Tray (10 x 1.2m)	906900	20001084
Universal Angle Hip/Ridge Junction	952000	20001211
Universal Angle Hip (without nail holes) Slate Grey	777730	10002352
Universal Angle Hip (without nail holes) Terracotta	777734	10002353
Universal Angle Hip (without nail holes) Tudor Brown	777736	10002354
Universal Angle Hip (without nail holes) Rustic Brown	822235	10002561
Universal Angle Hip (without nail holes) Richmond Red	822211	10002560
Universal Angle Hip (without nail holes) Charcoal Grey	777777	10002357
Universal Angle Hip (without nail holes) Black	777763	10002355
Universal Angle Hip (with nail holes) Slate Grey	777830	10002358
Universal Angle Hip (with nail holes) Terracotta	777834	10002359
Universal Angle Hip (with nail holes) Tudor Brown	777836	10002360
Universal Angle Hip (with nail holes) Rustic Brown	822335	10002563
Universal Angle Hip (with nail holes) Richmond Red	822311	10002562
Universal Angle Hip (with nail holes) Charcoal Grey	777877	10002363
Universal Angle Hip (with nail holes) Black	777863	10002361
Universal Angle Block-End Hip Slate Grey	777930	10002364
Universal Angle Block-End Hip Terracotta	777934	10002365
Universal Angle Block-End Hip Tudor Brown	777936	10002366
Universal Angle Block-End Hip Charcoal Grey	777977	10002369
Universal Angle Block-End Hip Black	777963	10002367
Universal Angle Block-End Hip Rustic Brown	822735	10002569
Universal Angle Block-End Hip Richmond Red	822711	10002568
Hip End Cap Universal Angle Terracotta	970434	10002848
Hip End Cap Universal Angle Black	970463	10002849
Mortar Bedded Fixing Kit	931400	10002814
VALLEY PRODUCTS		
125 GRP Valley (3m)	959500	20001231
Dry Valley (Low Profile) (3m)	957500	20001225
ABUTMENT PRODUCTS		
Top Edge Abutment Ventilation (3m)	954800	10002838
Wakaflex Rapid Flashing (see pages 148-149)	-	-
Abutment GRP Secret Gutter (3m)	959600	20001232
Bonding Strip (Low Profile) (3m)	958000	20001227
Bonding Strip (High Profile) (3m)	957800	20001226
RIDGE PRODUCTS		
DryVent Ridge (2.7m)	905900	10002748
Uni-Vent Rapid Ridge/Hip (10m)	931300	10002813
Continuous Ridge (5m)	930800	10002811
Universal Angle Ridge Slate Grey	714630	10002040
Universal Angle Ridge Terracotta	714634	10002041
Universal Angle Ridge Tudor Brown	714636	10002042
Universal Angle Ridge Rustic Brown	822135	10002559
Universal Angle Ridge Richmond Red	822111	10002558
Universal Angle Ridge Charcoal Grey	714677	10002045
Universal Angle Ridge Black	714663	10002043

Richmond 10 Slate

RIDGE PRODUCTS CONTINUED	Previous code	Code
Hi-Pitch Universal Angle Ridge Slate Grey	715130	10002052
Hi-Pitch Universal Angle Ridge Terracotta	715134	10002053
Universal Angle Block-End Ridge Slate Grey	751830	10002238
Universal Angle Block-End Ridge Terracotta	751834	10002239
Universal Angle Block-End Ridge Tudor Brown	751836	10002240
Universal Angle Block-End Ridge Rustic Brown	822635	10002567
Universal Angle Block-End Ridge Richmond Red	822611	10002566
Universal Angle Block-End Ridge Charcoal Grey	751877	10002243
Universal Angle Block-End Ridge Black	751863	10002241
DryVent Monoridge (2.7m)	908400	10002753
Universal Angle Monoridge Slate Grey	714830	10002046
Universal Angle Monoridge Terracotta	714834	10002047
Universal Angle Monoridge Tudor Brown	714836	10002048
Universal Angle Monoridge Rustic Brown	822435	10002565
Universal Angle Monoridge Richmond Red	822411	10002564
Universal Angle Monoridge Charcoal Grey	714877	10002051
Universal Angle Monoridge Black	714863	10002049
Universal Angle Monoridge End Cap LH Slate Grey	977830	20001388
Universal Angle Monoridge End Cap LH Rust	977855	20001389
Universal Angle Monoridge End Cap RH Slate Grey	977930	20001390
Universal Angle Monoridge End Cap RH Rust	977955	20001391
Mortar Bedded Fixing Kit	931400	10002814
Universal Angle Ridge End Cap Slate Grey	977330	20001254
Universal Angle Ridge End Cap Terracotta	977334	20001255
Universal Angle Ridge End Cap Rust	977355	20001256
Universal Angle Ridge End Cap Black	977363	20001257
VENTILATION TILES		
RedLine Vent Tile Black	914163	20001141
RedLine Vent Tile Rustic Brown	914140	20001140
RedLine Vent Tile Slate Grey	914130	20001138
RedLine Vent Tile Flame Red	914138	20001139
8.8k ThruVent Tile Slate Grey	794330	10002464
8.8k ThruVent Tile Flame Red	794338	10002465
8.8k ThruVent Tile Black	794363	10002467
8.8k ThruVent Tile Rustic Brown	794340	10002466
Rapid Roof Vent Tile Brown	912336	10002768
Rapid Roof Vent Tile Black	912363	10002769
Rapid Roof Vent Tile Grey	912330	10002766
Rapid Roof Vent Tile Terracotta	912334	10002767
Rapid Roof Vent Adaptor	979100	10002861
Flexible Pipe (100 to 100mm)	917200	20001149
FIXING		
Slate Clip (100) & Nail (100)	929400	20001400
Verge Clip (100)	948100	20001199
Eaves Clip (100)	929300	20001166
Slate Nails (Alum.Alloy) (approx 1060)	933400	20001174
Slate Nails (Stainless Steel) (approx 300)	935000	20001178
Eaves Clip Nails (approx 812)	933800	20001177
Kro-Clip (50)	914200	10003245
Innofix Clip Purple (250)	-	11000229

MockBond Richmond 10 Slate

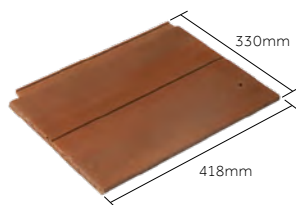

KEY FEATURES AND ADVANTAGES

- Small slate appearance, but with speed and ease of larger format installation
- Low minimum pitch adds versatility

PRODUCT DETAILS

Size	418 x 330mm
Minimum pitch and headlap	17.5° at 100mm headlap / 22.5° at 75mm headlap (The minimum pitch is based on a maximum rafter length of 10 metres. For rafter lengths greater than this, please contact Technical Services on 0330 123 4585)
Maximum pitch (subject to fixing specification and fire resistance requirements above 69°)	90°
Maximum headlap	125mm
Minimum gauge/batten spacing	293mm
Maximum gauge/batten spacing	below 22.5° 318mm / 22.5° and over 343mm
Hanging length (approx)	395mm
Cover (all figures are net and do not allow for wastage)	
Linear cover of 1 slate	300mm
Covering capacity	10.5 slates/m ² at 318mm gauge / 9.7 slates/m ² at 343mm gauge
Weight	51kg/m ² at 318mm gauge / 47kg/m ² at 343mm gauge
per pallet, including pallet (approx.)	1.07 tonnes
per 1000	4.81 tonnes
Battens required (at max. gauge)	2.92m/m ²
Batten size	
Rafter centres up to 450mm	38 x 25mm
Rafter centres up to 600mm	50 x 25mm
Fixing clips	Eaves, verge & slate clips
Nail size for slates*	45 x 3mm (A/A) 45 x 3.35mm (S/S)
Pallet quantities	Slates per pallet 210 / slates per pack 35 / packs per pallet 6

* (S/S) Stainless Steel Annular ring shanked (A/A) Aluminium Alloy

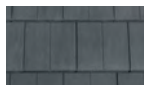

Slate Grey



Flame Red
(coated)

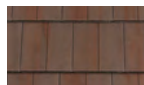

Rustic Brown
(coated)



Black
(coated)



MOCKBOND
RICHMOND 10 SLATE

CONCRETE

PRODUCT CODES

SLATE	Previous code	Code
MockBond Richmond 10 Slate Slate Grey	488130	10001789
MockBond Richmond 10 Slate Flame Red	488138	10001790
MockBond Richmond 10 Slate Black	488163	10001792
MockBond Richmond 10 Slate Rustic Brown	488140	10001791
Half Slate Pair Slate Grey	487230	10001784
Half Slate Pair Flame Red	487238	10001785
Half Slate Pair Black	487263	10001787
Half Slate Pair Rustic Brown	487240	10001786
UNDERLAYS		
Divoroll Elite 200 2S	915700	10002797
Divoroll Universal 2S	915600	10002796
EAVES PRODUCTS		
Rapid EavesVent 2-in-1 Tray	998800	20001276
Rapid EavesVent Rafter Roll (6m)	998400	20001275
RedVent 25 Over-Fascia Vent (6m)	959300	20001230
Underlay Support Tray (1.5m)	907600	20001461
VERGE PRODUCTS		
DryVerge (Pack of 18 LH & 18 RH) Charcoal Grey	939277	20001189
DryVerge (Pack of 18 LH & 18 RH) Slate Grey	939230	10003144
DryVerge (Pack of 18 LH & 18 RH) Terracotta	939234	10003145
DryVerge (Pack of 18 LH & 18 RH) Brown	939236	10003146
DryVerge Gable End Pack Charcoal Grey	988277	10002875
DryVerge Gable End Pack Slate Grey	988230	10002872
DryVerge Gable End Pack Terracotta	988234	10002873
DryVerge Gable End Pack Brown	988236	10002874
Rapid DryVerge (Pack of 18 LH & 18 RH) Slate Grey	939330	10002824
Rapid DryVerge (Pack of 18 LH & 18 RH) Rust	939355	10002825
Rapid DryVerge (Pack of 18 LH & 18 RH) Charcoal Grey	939377	10002826
Rapid DryVerge Cable End Pack Charcoal Grey	988377	10002878
Rapid DryVerge Cable End Pack Slate Grey	988330	10002876
Rapid DryVerge Cable End Pack Rust	988355	10002877

Fittings and components continued >

FITTINGS AND COMPONENTS

HIP PRODUCTS	Previous code	Code
Continuous Hip (5m)	952400	20001214
Uni-Vent Rapid Ridge/Hip (10m)	931300	10002813
Uni-Vent Rapid Hip Support Tray (10 x 1.2m)	906900	20001084
Universal Angle Hip/Ridge Junction	952000	20001211
Universal Angle Hip (without nail holes) Slate Grey	777730	10002352
Universal Angle Hip (without nail holes) Terracotta	777734	10002353
Universal Angle Hip (without nail holes) Tudor Brown	777736	10002354
Universal Angle Hip (without nail holes) Rustic Brown	822235	10002561
Universal Angle Hip (without nail holes) Richmond Red	822211	10002560
Universal Angle Hip (without nail holes) Charcoal Grey	777777	10002357
Universal Angle Hip (without nail holes) Black	777763	10002355
Universal Angle Hip (with nail holes) Slate Grey	777830	10002358
Universal Angle Hip (with nail holes) Terracotta	777834	10002359
Universal Angle Hip (with nail holes) Tudor Brown	777836	10002360
Universal Angle Hip (with nail holes) Rustic Brown	822335	10002563
Universal Angle Hip (with nail holes) Richmond Red	822311	10002562
Universal Angle Hip (with nail holes) Charcoal Grey	777877	10002363
Universal Angle Hip (with nail holes) Black	777863	10002361
Universal Angle Block-End Hip Slate Grey	777930	10002364
Universal Angle Block-End Hip Terracotta	777934	10002365
Universal Angle Block-End Hip Tudor Brown	777936	10002366
Universal Angle Block-End Hip Charcoal Grey	777977	10002369
Universal Angle Block-End Hip Black	777963	10002367
Universal Angle Block-End Hip Richmond Red	822711	10002568
Universal Angle Block-End Hip Rustic Brown	822735	10002569
Hip End Cap Universal Angle Terracotta	970434	10002848
Hip End Cap Universal Angle Black	970463	10002849
Mortar Bedded Fixing Kit	931400	10002814
VALLEY PRODUCTS		
125 GRP Valley (3m)	959500	20001231
Dry Valley (Low Profile) (3m)	957500	20001225
ABUTMENT PRODUCTS		
Top Edge Abutment Ventilation (3m)	954800	10002838
Wakaflex Rapid Flashing (see pages 148-149)		
Abutment GRP Secret Gutter (3m)	959600	20001232
Bonding Strip (Low Profile) (3m)	958000	20001227
Bonding Strip (High Profile) (3m)	957800	20001226
RIDGE PRODUCTS		
DryVent Ridge (2.7m)	905900	10002748
Uni-Vent Rapid Ridge/Hip (10m)	931300	10002813
Continuous Ridge (5m)	930800	10002811
Universal Angle Ridge Slate Grey	714630	10002040
Universal Angle Ridge Terracotta	714634	10002041
Universal Angle Ridge Tudor Brown	714636	10002042
Universal Angle Ridge Rustic Brown	822135	10002559
Universal Angle Ridge Richmond Red	822111	10002558
Universal Angle Ridge Charcoal Grey	714677	10002045
Universal Angle Ridge Black	714663	10002043

MockBond Richmond 10 Slate

RIDGE PRODUCTS CONTINUED	Previous code	Code
Hi-Pitch Universal Angle Ridge Slate Grey	715130	10002052
Hi-Pitch Universal Angle Ridge Terracotta	715134	10002053
Universal Angle Block-End Ridge Slate Grey	751830	10002238
Universal Angle Block-End Ridge Terracotta	751834	10002239
Universal Angle Block-End Ridge Tudor Brown	751836	10002240
Universal Angle Block-End Ridge Rustic Brown	822635	10002567
Universal Angle Block-End Ridge Richmond Red	822611	10002566
Universal Angle Block-End Ridge Charcoal Grey	751877	10002243
Universal Angle Block-End Ridge Black	751863	10002241
DryVent Monoridge (2.7m)	908400	10002753
Universal Angle Monoridge Slate Grey	714830	10002046
Universal Angle Monoridge Terracotta	714834	10002047
Universal Angle Monoridge Tudor Brown	714836	10002048
Universal Angle Monoridge Rustic Brown	822435	10002565
Universal Angle Monoridge Richmond Red	822411	10002564
Universal Angle Monoridge Charcoal Grey	714877	10002051
Universal Angle Monoridge Black	714863	10002049
Universal Angle Monoridge End Cap LH Slate Grey	977830	20001388
Universal Angle Monoridge End Cap LH Rust	977855	20001389
Universal Angle Monoridge End Cap RH Slate Grey	977930	20001390
Universal Angle Monoridge End Cap RH Rust	977955	20001391
Mortar Bedded Fixing Kit	931400	10002814
Universal Angle Ridge End Cap Slate Grey	977330	20001254
Universal Angle Ridge End Cap Terracotta	977334	20001255
Universal Angle Ridge End Cap Rust	977355	20001256
Universal Angle Ridge End Cap Black	977363	20001257
VENTILATION TILES		
RedLine Vent Tile Black	914163	20001141
RedLine Vent Tile Rustic Brown	914140	20001140
RedLine Vent Tile Slate Grey	914130	20001138
RedLine Vent Tile Flame Red	914138	20001139
8.8k ThruVent Tile Slate Grey	794330	10002464
8.8k ThruVent Tile Flame Red	794338	10002465
8.8k ThruVent Tile Black	794363	10002467
8.8k ThruVent Tile Rustic Brown	794340	10002466
Rapid Roof Vent Tile Brown	912336	10002768
Rapid Roof Vent Tile Black	912363	10002769
Rapid Roof Vent Tile Grey	912330	10002766
Rapid Roof Vent Tile Terracotta	912334	10002767
Rapid Roof Vent Adaptor	979100	10002861
Flexible Pipe (100 to 100mm)	917200	20001149
FIXING		
Slate Clip (100) & Nail (100)	929400	20001400
Verge Clip (100)	948100	20001199
Eaves Clip (100)	929300	20001166
Slate Nails (Alum.Alloy) (approx 1060)	933400	20001174
Slate Nails (Stainless Steel) (approx 300)	935000	20001178
Eaves Clip Nails (approx 812)	933800	20001177
Kro-Clip (50)	914200	10003245
Innofix Clip Purple (250)	-	11000229

Mini Stonewold

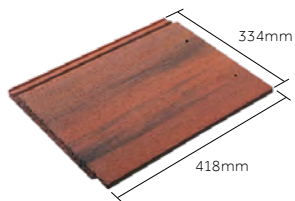

KEY FEATURES AND ADVANTAGES

- Low pitch capability
- Quick, simple installation reduces laid costs
- Range of seven natural colours

PRODUCT DETAILS

Size	418 x 334mm	
Minimum pitch and headlap	17.5° at 100mm headlap / 22.5° at 75mm headlap (The minimum pitch is based on a maximum rafter length of 10 metres. For rafter lengths greater than this, please contact Technical Services on 0330 123 4585)	
Maximum pitch (subject to fixing specification and fire resistance requirements above 69°)	90°	
Maximum headlap	125mm	
Minimum gauge/batten spacing	293mm	
Maximum gauge/batten spacing	below 22.5° 318mm / 22.5° and over 343mm	
Hanging length (approx)	397mm	
Cover (all figures are net and do not allow for wastage)		
Linear cover of 1 slate	294mm	
Covering capacity	10.7 slates/m ² at 318mm gauge / 9.9 slates/m ² at 343mm gauge	
Weight	55kg/m ² at 318mm gauge / 51kg/m ² at 343mm gauge	
per pallet, including pallet (approx.)	1.16 tonnes	
per 1000	5.11 tonnes	
Battens required (at max. gauge)	2.92m/m ²	
Batten size		
Rafter centres up to 450mm	38 x 25mm	
Rafter centres up to 600mm	50 x 25mm	
Fixing clips	Eaves, verge, valley & slate clips	
Nail size for slates*	50 x 3.35mm (A/A)	
Pallet quantities	Slates per pallet 216 / slates per pack 36 / packs per pallet 6	

*(A/A) Aluminium Alloy

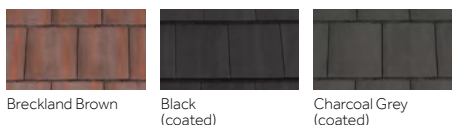
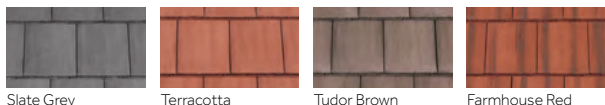

MINI STONEWOLD

CONCRETE

PRODUCT CODES

SLATE	Previous code	Code
Mini Stonewold Slate Breckland Brown	426152	10003054
Mini Stonewold Slate Slate Grey	426130	10001735
Mini Stonewold Slate Terracotta	426134	10003051
Mini Stonewold Slate Tudor Brown	426136	10003052
Mini Stonewold Slate Farmhouse Red	426139	10003053
Mini Stonewold Slate Charcoal Grey	426177	10001742
Mini Stonewold Slate Black	426163	10001740
Half Slate Pair Breckland Brown	426352	10003059
Half Slate Pair Slate Grey	426330	10003055
Half Slate Pair Terracotta	426334	10003056
Half Slate Pair Tudor Brown	426336	10003057
Half Slate Pair Farmhouse Red	426339	10003058
Half Slate Pair Charcoal Grey	426377	10001749
Half Slate Pair Black	426363	10001748
UNDERLAYS		
Divoroll Elite 200 2S	915700	10002797
Divoroll Universal 2S	915600	10002796
EAVES PRODUCTS		
Rapid EavesVent 2-in-1 Tray	998800	20001276
Rapid EavesVent Rafter Roll (6m)	998400	20001275
RedVent 25 Over-Fascia Vent (6m)	959300	20001230
Underlay Support Tray (1.5m)	907600	20001461
VERGE PRODUCTS		
DryVerge (Pack of 18 LH & 18 RH) Charcoal Grey	939077	10003123
DryVerge (Pack of 18 LH & 18 RH) Slate Grey	939030	10003217
DryVerge (Pack of 18 LH & 18 RH) Terracotta	939034	10003121
DryVerge (Pack of 18 LH & 18 RH) Brown	939036	10003122
DryVerge (Pack of 18 LH & 18 RH) Red	939078	10003247
Rapid DryVerge (Pack of 18 LH & 18 RH) Slate Grey	939130	10002821
Rapid DryVerge (Pack of 18 LH & 18 RH) Rust	939155	10002822
Rapid DryVerge (Pack of 18 LH & 18 RH) Charcoal Grey	939177	10002823
DryVerge Gable End Pack Charcoal Grey	988077	10002866
DryVerge Gable End Pack Slate Grey	988030	10002863
DryVerge Gable End Pack Terracotta	988034	10002864
DryVerge Gable End Pack Brown	988036	10002865
DryVerge Gable End Pack Red	988078	10002867
Rapid DryVerge Gable End Pack Slate Grey	988130	10002869
Rapid DryVerge Gable End Pack Rust	988155	10002870
Rapid DryVerge Gable End Pack Charcoal Grey	988177	10002871

Fittings and components continued >

FITTINGS AND COMPONENTS

HIP PRODUCTS	Previous code	Code
Continuous Hip (5m)	902800	20001082
Uni-Vent Rapid Ridge/Hip (10m)	931300	10002813
Uni-Vent Rapid Hip Support Tray (10 x 1.2m)	906900	20001084
Universal Angle Hip/Ridge Junction	952000	20001211
Universal Angle Hip (without nail holes) Slate Grey	777730	10002352
Universal Angle Hip (without nail holes) Terracotta	777734	10002353
Universal Angle Hip (without nail holes) Tudor Brown	777736	10002354
Universal Angle Hip (without nail holes) Charcoal Grey	777777	10002357
Universal Angle Hip (without nail holes) Black	777763	10002355
Universal Angle Hip (with nail holes) Slate Grey	777830	10002358
Universal Angle Hip (with nail holes) Terracotta	777834	10002359
Universal Angle Hip (with nail holes) Tudor Brown	777836	10002360
Universal Angle Hip (with nail holes) Charcoal Grey	777877	10002363
Universal Angle Hip (with nail holes) Black	777863	10002361
Universal Angle Block-End Hip Slate Grey	777930	10002364
Universal Angle Block-End Hip Terracotta	777934	10002365
Universal Angle Block-End Hip Tudor Brown	777936	10002366
Universal Angle Block-End Hip Charcoal Grey	777977	10002369
Universal Angle Block-End Hip Black	777963	10002367
Hip End Cap Universal Angle Terracotta	970434	10002848
Hip End Cap Universal Angle Black	970463	10002849
Mortar Bedded Fixing Kit	931400	10002814
VALLEY PRODUCTS		
125 GRP Valley (3m)	959500	20001231
Dry Valley (Low Profile) (3m)	957500	20001225
ABUTMENT PRODUCTS		
Top Edge Abutment Ventilation (3m)	954800	10002838
Wakaflex Rapid Flashing (see pages 148-149)	-	-
Abutment GRP Secret Gutter (3m)	959600	20001232
Bonding Strip (Low Profile) (3m)	958000	20001227
Bonding Strip (High Profile) (3m)	957800	20001226
RIDGE PRODUCTS		
DryVent Ridge (2.7m)	905900	10002748
Uni-Vent Rapid Ridge/Hip (10m)	931300	10002813
Continuous Ridge (5m)	930800	10002811
Universal Angle Ridge Slate Grey	714630	10002040
Universal Angle Ridge Terracotta	714634	10002041
Universal Angle Ridge Tudor Brown	714636	10002042
Universal Angle Ridge Charcoal Grey	714677	10002045
Universal Angle Ridge Black	714663	10002043
Hi-Pitch Universal Angle Ridge Slate Grey	715130	10002052
Hi-Pitch Universal Angle Ridge Terracotta	715134	10002053

Mini Stonewold

RIDGE PRODUCTS CONTINUED	Previous code	Code
Universal Angle Block-End Ridge Slate Grey	751830	10002238
Universal Angle Block-End Ridge Terracotta	751834	10002239
Universal Angle Block-End Ridge Tudor Brown	751836	10002240
Universal Angle Block-End Ridge Charcoal Grey	751877	10002243
Universal Angle Block-End Ridge Black	751863	10002241
DryVent Monoridge (2.7m)	908400	10002753
Universal Angle Monoridge Slate Grey	714830	10002046
Universal Angle Monoridge Terracotta	714834	10002047
Universal Angle Monoridge Tudor Brown	714836	10002048
Universal Angle Monoridge Charcoal Grey	714877	10002051
Universal Angle Monoridge Black	714863	10002049
Universal Angle Monoridge End Cap LH Slate Grey	977830	20001388
Universal Angle Monoridge End Cap LH Rust	977855	20001389
Universal Angle Monoridge End Cap RH Slate Grey	977930	20001390
Universal Angle Monoridge End Cap RH Rust	977955	20001391
Mortar Bedded Fixing Kit	931400	10002814
Universal Angle Ridge End Cap Slate Grey	977330	20001254
Universal Angle Ridge End Cap Terracotta	977334	20001255
Universal Angle Ridge End Cap Rust	977355	20001256
Universal Angle Ridge End Cap Black	977363	20001257
VENTILATION TILES		
RedLine Vent Tile Charcoal Grey	911877	20001118
RedLine Vent Tile Farmhouse Red	911839	20001115
RedLine Vent Tile Black	911863	20001117
RedLine Vent Tile Breckland Brown	911852	20001116
RedLine Vent Tile Slate Grey	911830	20001112
RedLine Vent Tile Terracotta	911834	20001113
RedLine Vent Tile Tudor Brown	911836	20001114
8.8k ThruVent Tile Breckland Brown	793552	10002457
8.8k ThruVent Tile Slate Grey	793530	10002453
8.8k ThruVent Tile Terracotta	793534	10002454
8.8k ThruVent Tile Tudor Brown	793536	10002455
8.8k ThruVent Tile Farmhouse Red	793539	10002456
8.8k ThruVent Tile Charcoal Grey	793577	11000227
8.8k ThruVent Tile Black	793563	10002458
Rapid Roof Vent Tile Brown	912436	10002772
Rapid Roof Vent Tile Terracotta	912434	10002771
Rapid Roof Vent Tile Grey	912430	10002770
Rapid Roof Vent Adaptor	979100	10002861
Flexible Pipe (100 to 100mm)	917200	20001149
FIXINGS		
Slate Clip (100) & Nail (100)	918500	20001394
Storm Clip (100) & Nail (100)	953000	20001403
Verge Clip (25)	952900	20001402
Eaves Clip (100)	918600	20001155
Tile and Eaves Clip (Alum. Alloy) (approx 812)	933800	20001177
Kro-Clip (50)	914200	10003245
Innofix Clip Gold (250)	982400	11000231

MockBond Mini Stonewold

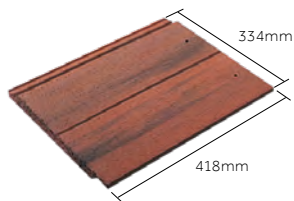

KEY FEATURES AND ADVANTAGES

- Small tile roof appearance, but with speed and ease of larger format installation
- Quick, simple installation reduces laid costs
- Available in five attractive colours

PRODUCT DETAILS

Size	418 x 334mm
Minimum pitch and headlap	17.5° at 100mm headlap / 22.5° at 75mm headlap (The minimum pitch is based on a maximum rafter length of 10 metres. For rafter lengths greater than this, please contact Technical Services on 0330 123 4585)
Maximum pitch (subject to fixing specification and fire resistance requirements above 69°)	90°
Maximum headlap	125mm
Minimum gauge/batten spacing	293mm
Maximum gauge/batten spacing	below 22.5° 318mm / 22.5° and over 343mm
Hanging length (approx)	397mm
Cover (all figures are net and do not allow for wastage)	
Linear cover of 1 slate	294mm
Covering capacity	10.7 slates/m ² at 318mm gauge / 9.9 slates/m ² at 343mm gauge
Weight	55kg/m ² at 318mm gauge / 51kg/m ² at 343mm gauge
per pallet, including pallet (approx.)	1.16 tonnes
per 1000	5.11 tonnes
Battens required (at max. gauge)	2.92m/m ²
Batten size	
Rafter centres up to 450mm	38 x 25mm
Rafter centres up to 600mm	50 x 25mm
Fixing clips	Eaves, verge, valley & slate clips
Nail size for slates*	50 x 3.35mm (A/A)
Pallet quantities	Slates per pallet 216 / slates per pack 36 / packs per pallet 6

*(A/A) Aluminium Alloy



Slate Grey

Breckland Brown

Farmhouse Red

Charcoal Grey (coated)



MOCKBOND MINI
STONEWOLD

CONCRETE

PRODUCT CODES

SLATE	Previous code	Code
MockBond Mini Stonewold Breckland Brown	427152	10001753
MockBond Mini Stonewold Slate Grey	427139	10003060
MockBond Mini Stonewold Farmhouse Red	427139	10003061
MockBond Mini Stonewold Charcoal Grey	427177	10001754
Half Slate Pair Breckland Brown	426352	10003059
Half Slate Pair Slate Grey	426330	10003055
Half Slate Pair Farmhouse Red	426339	10003058
Half Slate Pair Charcoal Grey	426377	10001749
UNDERLAYS		
Divoroll Elite 200 2S	915700	10002797
Divoroll Universal 2S	915600	10002796
EAVES PRODUCTS		
Rapid EavesVent 2-in-1 Tray	998800	20001276
Rapid EavesVent Rafter Roll (6m)	998400	20001275
RedVent 25 Over-Fascia Vent (6m)	959300	20001230
Underlay Support Tray (1.5m)	907600	20001461
VERGE PRODUCTS		
DryVerge (Pack of 18 LH & 18 RH) Charcoal Grey	939077	10003123
DryVerge (Pack of 18 LH & 18 RH) Slate Grey	939030	10003217
DryVerge (Pack of 18 LH & 18 RH) Terracotta	939034	10003121
DryVerge (Pack of 18 LH & 18 RH) Brown	939036	10003122
DryVerge (Pack of 18 LH & 18 RH) Red	939078	10003247
Rapid DryVerge (Pack of 18 LH & 18 RH) Slate Grey	939130	10002821
Rapid DryVerge (Pack of 18 LH & 18 RH) Rust	939155	10002822
Rapid DryVerge (Pack of 18 LH & 18 RH) Charcoal Grey	939177	10002823
DryVerge Gable End Pack Charcoal Grey	988077	10002866
DryVerge Gable End Pack Slate Grey	988030	10002863
DryVerge Gable End Pack Terracotta	988034	10002864
DryVerge Gable End Pack Brown	988036	10002865
DryVerge Gable End Pack Red	988078	10002867
Rapid DryVerge Gable End Pack Slate Grey	988130	10002869
Rapid DryVerge Gable End Pack Rust	988155	10002870
Rapid DryVerge Gable End Pack Charcoal Grey	988177	10002871

Fittings and components continued >

FITTINGS AND COMPONENTS

HIP PRODUCTS	Previous code	Code
Continuous Hip (5m)	902800	20001082
Uni-Vent Rapid Ridge/Hip (10m)	931300	10002813
Uni-Vent Rapid Hip Support Tray (10 x 1.2m)	906900	20001084
Universal Angle Hip/Ridge Junction	952000	20001211
Universal Angle Hip (without nail holes) Slate Grey	777730	10002352
Universal Angle Hip (without nail holes) Terracotta	777734	10002353
Universal Angle Hip (without nail holes) Tudor Brown	777736	10002354
Universal Angle Hip (without nail holes) Charcoal Grey	777777	10002357
Universal Angle Hip (without nail holes) Black	777763	10002355
Universal Angle Hip (with nail holes) Slate Grey	777830	10002358
Universal Angle Hip (with nail holes) Terracotta	777834	10002359
Universal Angle Hip (with nail holes) Tudor Brown	777836	10002360
Universal Angle Hip (with nail holes) Charcoal Grey	777877	10002363
Universal Angle Hip (with nail holes) Black	777863	10002361
Universal Angle Block-End Hip Slate Grey	777930	10002364
Universal Angle Block-End Hip Terracotta	777934	10002365
Universal Angle Block-End Hip Tudor Brown	777936	10002366
Universal Angle Block-End Hip Charcoal Grey	777977	10002369
Universal Angle Block-End Hip Black	777963	10002367
Hip End Cap Universal Angle Terracotta	970434	10002848
Hip End Cap Universal Angle Black	970463	10002849
Mortar Bedded Fixing Kit	931400	10002814
VALLEY PRODUCTS		
125 GRP Valley (3m)	959500	20001231
Dry Valley (Low Profile) (3m)	957500	20001225
ABUTMENT PRODUCTS		
Top Edge Abutment Ventilation (3m)	954800	10002838
Wakaflex Rapid Flashing (see pages 148-149)		
Abutment GRP Secret Gutter (3m)	959600	20001232
Bonding Strip (Low Profile) (3m)	958000	20001227
Bonding Strip (High Profile) (3m)	957800	20001226
RIDGE PRODUCTS		
DryVent Ridge (2.7m)	905900	10002748
Uni-Vent Rapid Ridge/Hip (10m)	931300	10002813
Continuous Ridge (5m)	930800	10002811
Universal Angle Ridge Slate Grey	714630	10002040
Universal Angle Ridge Terracotta	714634	10002041
Universal Angle Ridge Tudor Brown	714636	10002042
Universal Angle Ridge Charcoal Grey	714677	10002045
Universal Angle Ridge Black	714663	10002043

MockBond Mini Stonewold

RIDGE PRODUCTS CONTINUED	Previous code	Code
Hi-Pitch Universal Angle Ridge Slate Grey	715130	10002052
Hi-Pitch Universal Angle Ridge Terracotta	715134	10002053
Universal Angle Block-End Ridge Slate Grey	751830	10002238
Universal Angle Block-End Ridge Terracotta	751834	10002239
Universal Angle Block-End Ridge Tudor Brown	751836	10002240
Universal Angle Block-End Ridge Charcoal Grey	751877	10002243
Universal Angle Block-End Ridge Black	751863	10002241
DryVent Monoridge (2.7m)	908400	10002753
Universal Angle Monoridge Slate Grey	714830	10002046
Universal Angle Monoridge Terracotta	714834	10002047
Universal Angle Monoridge Tudor Brown	714836	10002048
Universal Angle Monoridge Charcoal Grey	714877	10002051
Universal Angle Monoridge Black	714863	10002049
Universal Angle Monoridge End Cap LH Slate Grey	977830	20001388
Universal Angle Monoridge End Cap LH Rust	977855	20001389
Universal Angle Monoridge End Cap RH Slate Grey	977930	20001390
Universal Angle Monoridge End Cap RH Rust	977955	20001391
Mortar Bedded Fixing Kit	931400	10002814
Universal Angle Ridge End Cap Slate Grey	977330	20001254
Universal Angle Ridge End Cap Terracotta	977334	20001255
Universal Angle Ridge End Cap Rust	977355	20001256
Universal Angle Ridge End Cap Black	977363	20001257
VENTILATION TILES		
RedLine Vent Tile Charcoal Grey	911877	20001118
RedLine Vent Tile Farmhouse Red	911839	20001115
RedLine Vent Tile Breckland Brown	911852	20001116
RedLine Vent Tile Slate Grey	911830	20001112
8.8k ThruVent Tile Breckland Brown	793552	10002457
8.8k ThruVent Tile Slate Grey	793530	10002453
8.8k ThruVent Tile Farmhouse Red	793539	10002456
8.8k ThruVent Tile Charcoal Grey	793577	10002459
Rapid Roof Vent Tile Brown	912436	10002772
Rapid Roof Vent Tile Terracotta	912434	10002771
Rapid Roof Vent Tile Grey	912430	10002770
Rapid Roof Vent Adaptor	979100	10002861
Flexible Pipe (100 to 100mm)	917200	20001149
FIXING		
Slate Clip (100) & Nail (100)	918500	20001394
Storm Clip (100) & Nail (100)	953000	20001403
Verge Clip (25)	952900	20001402
Eaves Clip (100)	918600	20001155
Tile and Eaves Clip (Alum. Alloy) (approx 812)	933800	20001177
Kro-Clip (50)	914200	10003245
Innofix Clip Gold (250)	982400	11000231

Plain Tile Range

The name 'plain' does not give credit to the incredible scope and variety of this uniquely versatile roofing material.

Fired clay plain tiles were in use as early as the 14th century. But it was only after the Great Fire of London in 1666, when thatched roofing was no longer allowed in the city, that their use became widespread.

The BMI Redland plain tile range offers a huge selection of colours and finishes to match the many and varied styles still seen around the UK. With a wide choice of double lapped clay and concrete plain tiles suited to almost any pitched roof design, they will produce striking roofs of timeless quality.



	Rosemary Clay Craftsman	Rosemary Clay Classic	Heathland
Page no.	42-45	46-49	50-53
Min. pitch	35°	35°	35°
Weight*	77kg/m ²	77kg/m ²	75kg/m ²
Cover*	60 tiles/m ²	60 tiles/m ²	60 tiles/m ²

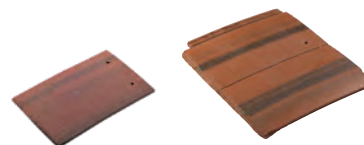

	Plain Tile	DuoPlain
Page no.	54-59	60-63
Min. pitch	35°	25°
Weight*	75kg/m ²	54kg/m ²
Cover*	60 tiles/m ²	17.7 tiles/m ²

* Depends on headlap used.
Refer to product pages for full technical information.

Rosemary Clay Craftsman

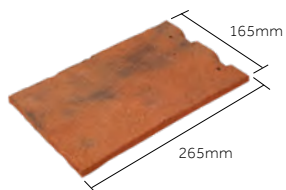

KEY FEATURES AND ADVANTAGES

- Traditional handmade clay tile look
- Made in Britain from high-strength Etruria Marl clay
- Three time-honoured heritage colours

PRODUCT DETAILS

Size	265 x 165mm
Minimum pitch	35°
Maximum pitch (subject to fixing specification)	90°
Minimum headlap	below 90° 65mm / at 90° 35mm
Maximum headlap	88mm
Minimum gauge/batten spacing	88mm
Maximum gauge/batten spacing	below 90° 100mm / at 90° 115mm
Hanging length (approx)	254mm
Cover (all figures are net and do not allow for wastage)	
Linear cover of 1 tile	165mm
Covering capacity	below 90° 60 tiles/m ² / at 90° 52 tiles/m ²
Weight per pallet, including pallet (approx.) per 1000	below 90° 77kg/m ² / at 90° 67kg/m ² 0.94 tonnes 1.29 tonnes
Battens required (at max. gauge)	below 90° 10.0m/m ²
Batten size Rafter centres up to 600mm	38 x 25mm
Nail size for tiles*	40 x 2.65mm (A/A)
Pallet quantities	Tiles per pallet 720 / tiles per pack 12 / packs per pallet 60

*(A/A) Aluminium Alloy

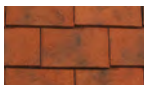

Hawkhurst (sanded)

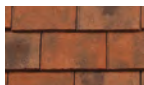

Albury (sanded)

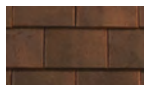

Victorian



Rosemary

ROSEMARY
CLAY CRAFTSMAN

CLAY

PRODUCT CODES

TILES	Previous code	Code
Rosemary Clay Craftsman tile Hawkhurst	692184	10001991
Rosemary Clay Craftsman tile Albury	692185	10001992
Rosemary Clay Craftsman tile Victorian	692198	10001993
Eaves/Top Tile Hawkhurst	692484	10001995
Eaves/Top Tile Albury	692485	10001996
Eaves/Top Tile Victorian	692498	10001997
Tile-and-a-half Hawkhurst	692984	10001998
Tile-and-a-half Albury	692985	10001999
Tile-and-a-half Victorian	692998	10002000
UNDERLAYS		
Divoroll Elite 200 2S	915700	10002797
Divoroll Universal 2S	915600	10002796
EAVES PRODUCTS		
Rapid EavesVent 2-in-1 Tray	998800	20001276
Rapid EavesVent Rafter Roll (6m)	998400	20001275
RedVent 25 Over-Fascia Vent (6m)	959300	20001230
Underlay Support Tray (1.5m)	907600	20001461
HIP PRODUCTS		
Continuous Hip (5m)	952400	20001214
Uni-Vent Rapid Ridge/Hip (10m)	931300	10002813
Uni-Vent Rapid Hip Support Tray (10 x 1.2m)	906900	20001084
Third Round Hip/Ridge Junction	952100	20001212
Bonnet Hip Tile 35°-50° Hawkhurst	843084	10002631
Bonnet Hip Tile 35°-50° Albury	843085	10002632
Bonnet Hip Tile 35°-50° Victorian	843098	10002637
Rosemary Third Round Hip (without nail holes) Hawkhurst	845484	10002696
Rosemary Third Round Hip (without nail holes) Albury	845485	10002697
Rosemary Third Round Hip (without nail holes) Victorian	845498	10002702
Rosemary Third Round Hip (with nail holes) Hawkhurst	845584	10002707
Rosemary Third Round Hip (with nail holes) Albury	845585	10002708
Rosemary Third Round Hip (with nail holes) Victorian	845598	10002713

Fittings and components continued >



HIP PRODUCTS CONTINUED	Previous code	Code
Baby Ridge Hawkhurst	848284	10002724
Baby Ridge Albury	848285	10002725
Baby Ridge Victorian	848298	10002730
Mortar Bedded Fixing Kit	931400	10002814
Hip End Cap Third Round Terracotta	971234	10002850
Hip End Cap Third Round Brown	971236	10002851
Hip End Cap Third Round Black	971263	10002852
VALLEY PRODUCTS		
Angular Valley Tile 35° Hawkhurst	843184	10002642
Angular Valley Tile 35° Albury	843185	10002643
Angular Valley Tile 35° Victorian	843198	10002648
Angular Valley Tile 40°-50° Hawkhurst	843784	10003004
Angular Valley Tile 40°-50° Albury	843785	10002653
Angular Valley Tile 40°-50° Victorian	843798	10002658
GRP 125 Valley (3m)	959500	20001231
Dry Valley (High Profile) (3m)	957400	20001224
ABUTMENT PRODUCTS		
Top Edge Abutment Ventilation (3m)	954800	10002838
Wakaflex Rapid Flashing (see pages 148-149)		
Bonding Strip (3m)	957800	20001226
RIDGE PRODUCTS		
DryVent Ridge (1.8m)	905600	10002746
Clay Half Round Ridge Hawkhurst	845084	10002685
Clay Half Round Ridge Albury	845085	10002686
Clay Half Round Ridge Victorian	845098	10002691
Mortar Bedded Fixing Kit	931400	10002814
VENTILATION TILES		
RedLine Plain Tile Vent Autumn	911923	20001124
RedLine Plain Tile Vent Dark Antique	911995	20001135
RedLine Vent Adaptor	917500	10002798
Flexible Pipe (100 to 100mm)	917200	20001149
EXTERNAL VERTICAL ANGLES		
External Angle 90° LH Hawkhurst	844184	10002674
External Angle 90° LH Albury	844185	10002675
External Angle 90° LH Victorian	844198	10002680
External Angle 90° RH Hawkhurst	844084	10002663
External Angle 90° RH Albury	844085	10002664
External Angle 90° RH Victorian	844098	10002669
FIXING		
Tile Nail (Alum. Alloy) (approx 1596)	933100	20001172
Kro-Clip (50)	914200	10003245
ORNAMENTAL TILES		
Rosemary Craftsman Club Tile Hawkhurst	652184	10001934
Rosemary Craftsman Club Tile Albury	652185	10001935
Rosemary Craftsman Club Tile Victorian	652198	10001940

Rosemary Clay Classic

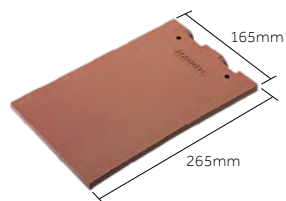

KEY FEATURES AND ADVANTAGES

- Rich history and heritage. In production since 1837
- Made in Britain from high-strength Etruria Marl clay
- A range of colours and finishes to harmonise with the history and character of your area

PRODUCT DETAILS

Size	265 x 165mm
Minimum pitch	35°
Maximum pitch (subject to fixing specification)	90°
Minimum headlap	below 90° 65mm / at 90° 35mm
Maximum headlap	88mm
Minimum gauge/batten spacing	88mm
Maximum gauge/batten spacing	below 90° 100mm / at 90° 115mm
Hanging length (approx)	254mm
Cover (all figures are net and do not allow for wastage)	
Linear cover of 1 tile	165mm
Covering capacity	below 90° 60 tiles/m ² / at 90° 52 tiles/m ²
Weight per pallet, including pallet (approx. per 1000)	below 90° 77kg/m ² / at 90° 67kg/m ² 1.10 tonnes 1.29 tonnes
Battens required (at max. gauge)	below 90° 10.0m/m ²
Batten size	
Rafter centres up to 600mm	38 x 25mm
Nail size for tiles*	40 x 2.65mm (A/A)
Pallet quantities	Tiles per pallet 840 / tiles per pack 14 / packs per pallet 60

*(A/A) Aluminium Alloy

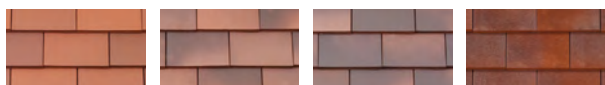

Red Light Mixed Brindle Medium Mixed Brindle Heather Brindle (sanded)



Blue Brindle Burnt Blend (sanded) Russet Mix (sanded) cross-cambered Dark Antique



ROSEMARY
CLAY CLASSIC

CLAY

PRODUCT CODES

TILES	Previous code	Code
Rosemary Clay Classic tile Red	650180	10001926
Rosemary Clay Classic tile Russet Mix	670194	10001978
Rosemary Clay Classic tile Light Mixed Brindle	680181	10001982
Rosemary Clay Classic tile Medium Mixed Brindle	680182	10001983
Rosemary Clay Classic tile Blue Brindle	680187	10001984
Rosemary Clay Classic tile Heather Brindle	660183	10001943
Rosemary Clay Classic tile Burnt Blend	660191	10001944
Rosemary Clay Classic tile Dark Antique	660195	10001945
Eaves/Top Tile Red	650480	10001927
Eaves/Top Tile Russet Mix	670494	10001979
Eaves/Top Tile Light Mixed Brindle	680481	10001985
Eaves/Top Tile Medium Mixed Brindle	680482	10001986
Eaves/Top Tile Blue Brindle	680487	10001987
Eaves/Top Tile Heather Brindle	660483	10001947
Eaves/Top Tile Burnt Blend	660491	10001948
Eaves/Top Tile Dark Antique	660495	10001949
Tile-and-a-Half Red	650980	10001928
Tile-and-a-Half Russet Mix	670994	10001980
Tile-and-a-Half Light Mixed Brindle	680981	10001988
Tile-and-a-Half Medium Mixed Brindle	680982	10001989
Tile-and-a-Half Blue Brindle	680987	10001990
Tile-and-a-Half Heather Brindle	660983	10001950
Tile-and-a-Half Burnt Blend	660991	10001951
Tile-and-a-Half Dark Antique	660995	10001952
UNDERLAYS		
Divoroll Elite 200 2S	915700	10002797
Divoroll Universal 2S	915600	10002796
EAVES PRODUCTS		
Rapid EavesVent 2-in-1 Tray	998800	20001276
Rapid EavesVent Rafter Roll (6)	998400	20001275
RedVent 25 Over-Fascia Vent (6m)	959300	20001230
Underlay Support Tray (1.5m)	907600	20001461
HIP PRODUCTS		
Continuous Hip (5m)	952400	20001214
Uni-Vent Rapid Ridge/Hip (10m)	931300	10002813
Uni-Vent Rapid Hip Support Tray (10 x 1.2m)	906900	20001084
Third Round Hip/Ridge Junction	952100	20001212
Bonnet Hip Tile 35°-50° Red	843080	10002627
Bonnet Hip Tile 35°-50° LMB	843081	10002628
Bonnet Hip Tile 35°-50° MMB	843082	10002629
Bonnet Hip Tile 35°-50° Blue Brindle	843087	10002633
Bonnet Hip Tile 35°-50° Heather Brindle	843083	10002630
Bonnet Hip Tile 35°-50° Burnt Blend	843091	10002634
Bonnet Hip Tile 35°-50° Russet Mix	843094	10002635
Bonnet Hip Tile 35°-50° Dark Antique	843095	10002636

Fittings and components continued >

HIP PRODUCTS CONTINUED	Previous code	Code
Arris Hip 35° Red	841180	10002603
Arris Hip 35° LMB	841181	10002604
Arris Hip 35° MMB	841182	10002605
Arris Hip 35° Blue Brindle	841187	10002606
Arris Hip 35° Burnt Blend	841191	10002607
Arris Hip 35° Dark Antique	841195	10002608
Arris Hip 40° Red	841280	10002609
Arris Hip 40° LMB	841281	10002610
Arris Hip 40° MMB	841282	10002611
Arris Hip 40° Blue Brindle	841287	10002612
Arris Hip 40° Burnt Blend	841291	10002613
Arris Hip 40° Dark Antique	841295	10002614
Arris Hip 45° Red	841380	10002615
Arris Hip 45° LMB	841381	10002616
Arris Hip 45° MMB	841382	10002617
Arris Hip 45° Blue Brindle	841387	10002618
Arris Hip 45° Burnt Blend	841391	10002619
Arris Hip 45° Dark Antique	841395	10002620
Arris Hip 50° Red	841480	10002621
Arris Hip 50° LMB	841481	10002622
Arris Hip 50° MMB	841482	10002623
Arris Hip 50° Blue Brindle	841487	10002624
Arris Hip 50° Burnt Blend	841491	10002625
Arris Hip 50° Dark Antique	841495	10002626
Clay Third Round Hip (without nail holes) Red	845480	10002692
Clay Third Round Hip (without nail holes) LMB	845481	10002693
Clay Third Round Hip (without nail holes) MMB	845482	10002694
Clay Third Round Hip (without nail holes) Blue Brindle	845487	10002698
Clay Third Round Hip (without nail holes) Heather Brindle	845483	10002695
Clay Third Round Hip (without nail holes) Burnt Blend	845491	10002699
Clay Third Round Hip (without nail holes) Russet Mix	845494	10002700
Clay Third Round Hip (without nail holes) Dark Antique	845495	10002701
Clay Third Round Hip (with nail holes) Red	845580	10002703
Clay Third Round Hip (with nail holes) LMB	845581	10002704
Clay Third Round Hip (with nail holes) MMB	845582	10002705
Clay Third Round Hip (with nail holes) Blue Brindle	845587	10002709
Clay Third Round Hip (with nail holes) Heather Brindle	845583	10002706
Clay Third Round Hip (with nail holes) Burnt Blend	845591	10002710
Clay Third Round Hip (with nail holes) Russet Mix	845594	10002711
Clay Third Round Hip (with nail holes) Dark Antique	845595	10002712
Baby Ridge Red	848280	10002720
Baby Ridge LMB	848281	10002721
Baby Ridge MMB	848282	10002722
Baby Ridge Blue Brindle	848287	10002726
Baby Ridge Heather Brindle	848283	10002723
Baby Ridge Burnt Blend	848291	10002727
Baby Ridge Russet Mix	848294	10002728
Baby Ridge Dark Antique	848295	10002729
Mortar Bedded Fixing Kit	931400	10002814
Hip End Cap Third Round Terracotta	971234	10002850
Hip End Cap Third Round Brown	971236	10002851
Hip End Cap Third Round Black	971263	10002852
VALLEY PRODUCTS		
Angular Valley Tile 35° Red	843180	10002638
Angular Valley Tile 35° LMB	843181	10002639
Angular Valley Tile 35° MMB	843182	10002640
Angular Valley Tile 35° Blue Brindle	843187	10002644
Angular Valley Tile 35° Heather Brindle	843183	10002641
Angular Valley Tile 35° Burnt Blend	843191	10002645
Angular Valley Tile 35° Russet Mix	843194	10002646
Angular Valley Tile 35° Dark Antique	843195	10002647
Angular Valley Tile 40°-50° Red	843780	10002649
Angular Valley Tile 40°-50° LMB	843781	10002650

VALLEY PRODUCTS CONTINUED	Previous code	Code
Angular Valley Tile 40°-50° MMB	843782	10002651
Angular Valley Tile 40°-50° Blue Brindle	843787	10002654
Angular Valley Tile 40°-50° Heather Brindle	843783	10002652
Angular Valley Tile 40°-50° Burnt Blend	843791	10002655
Angular Valley Tile 40°-50° Russet Mix	843794	10002656
Angular Valley Tile 40°-50° Dark Antique	843795	10002657
GRP 125 Valley (3m)	959500	20001231
Dry Valley (High Profile) (3m)	957400	20001224
ABUTMENT PRODUCTS		
Top Edge Abutment Ventilation (3m)	954800	10002838
Wakaflex Rapid Flashing (see pages 148-149)		
Bonding Strip (High Profile) (3m)	957800	20001226
RIDGE PRODUCTS		
DryVent Ridge (1.8m)	905600	10002746
Clay Half Round Ridge Red	845080	10002681
Clay Half Round Ridge LMB	845081	10002682
Clay Half Round Ridge MMB	845082	10002683
Clay Half Round Ridge Blue Brindle	845087	10002687
Clay Half Round Ridge Heather Brindle	845083	10002684
Clay Half Round Ridge Burnt Blend	845091	10002688
Clay Half Round Ridge Russet Mix	845094	10002689
Clay Half Round Ridge Dark Antique	845095	10002690
Mortar Bedded Fixing Kit	931400	10002814
VENTILATION TILES		
RedLine Plain Tile Vent Red	911980	20001132
RedLine Plain Tile Vent Medium Mixed Brindle	911982	20001133
RedLine Plain Tile Vent Blue Brindle	911987	20001134
RedLine Plain Tile Vent Dark Antique	911995	20001135
RedLine Plain Tile Vent Heather Brindle	911926	20001125
RedLine Plain Tile Vent Autumn	911923	20001124
RedLine Plain Tile Vent Russet Mix	911918	20001122
RedLine Vent Adaptor	917500	10002798
Flexible Pipe (100 to 100mm)	917200	20001149
EXTERNAL VERTICAL ANGLES		
External Angle 90° LH Red	844180	10002670
External Angle 90° LH LMB	844181	10002671
External Angle 90° LH MMB	844182	10002672
External Angle 90° LH Blue Brindle	844187	10002676
External Angle 90° LH Heather Brindle	844183	10002673
External Angle 90° LH Burnt Blend	844191	10002677
External Angle 90° LH Russet Mix	844194	10002678
External Angle 90° LH Dark Antique	844195	10002679
External Angle 90° RH Red	844080	10002659
External Angle 90° RH LMB	844081	10002660
External Angle 90° RH MMB	844082	10002661
External Angle 90° RH Blue Brindle	844087	10002665
External Angle 90° RH Heather Brindle	844083	10002662
External Angle 90° RH Burnt Blend	844091	10002666
External Angle 90° RH Russet Mix	844094	10002667
External Angle 90° RH Dark Antique	844095	10002668
FIXING		
Tile Nail (Alum. Alloy) (approx 1596)	933100	20001172
Kro-Clip (50)	914200	10003245
ORNAMENTAL TILES		
Rosemary Classic Club Tile Red	652180	10001930
Rosemary Classic Club Tile LMB	652181	10001931
Rosemary Classic Club Tile MMB	652182	10001932
Rosemary Classic Club Tile Blue Brindle	652187	10001936
Rosemary Classic Club Tile Heather Brindle	652183	10001933
Rosemary Classic Club Tile Burnt Blend	652191	10001937
Rosemary Classic Club Tile Russet Mix	652194	10001938
Rosemary Classic Club Tile Dark Antique	652195	10001939

Heathland

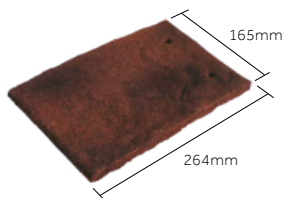

KEY FEATURES AND ADVANTAGES

- Concrete tile with randomly applied fine sand coating
- Varying hanging length†
- Offers practical and economic alternative to handmade clay tiles

PRODUCT DETAILS

Size	264 x 165mm
Minimum pitch	35°
Maximum pitch (subject to fixing specification)	90°
Minimum headlap	below 90° 65mm / at 90° 35mm
Maximum headlap	88mm
Minimum gauge/batten spacing	88mm
Maximum gauge/batten spacing	below 90° 100mm / at 90° 115mm
Hanging length (approx)	244mm
Cover (all figures are net and do not allow for wastage)	
Linear cover of 1 tile	165mm
Covering capacity	below 90° 60 tiles/m ² / at 90° 52 tiles/m ²
Weight per pallet, including pallet (approx.) per 1000	below 90° 75kg/m ² / at 90° 65kg/m ² 1.01 tonnes 1.25 tonnes
Battens required (at max. gauge)	below 90° 10.0m/m ²
Batten size Rafter centres up to 600mm	38 x 25mm
Nail size for tiles*	40 x 2.65mm (A/A)
Pallet quantities	Tiles per pallet 768 / tiles per pack 16 / packs per pallet 48

† Variation in hanging length and linear cover is a purpose designed feature of this tile and therefore the relevant clauses of BS EN 490 do not apply.

*(A/A) Aluminium Alloy

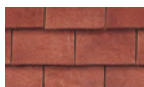

Wealden Red (sanded)

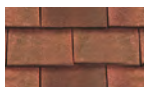

Autumn (sanded)



HEATHLAND

CONCRETE

PRODUCT CODES

TILES	Previous code	Code
Heathland Tile Autumn	666123	10001955
Heathland Tile Wealden Red	666122	10001954
Eaves/Top Tile Autumn	666423	10001963
Eaves/Top Tile Wealden Red	666422	10001962
Tile-and-a-half Autumn	666923	10001968
Tile-and-a-half Wealden Red	666922	10001967
UNDERLAYS		
Divoroll Elite 200 2S	915700	10002797
Divoroll Universal 2S	915600	10002796
EAVES PRODUCTS		
Rapid EavesVent 2-in-1 Tray	998800	20001276
Rapid EavesVent Rafter Roll (6m)	998400	20001275
RedVent 25 Over-Fascia Vent (6m)	959300	20001230
Underlay Support Tray (1.5m)	907600	20001461
HIP PRODUCTS		
Continuous Hip (5m)	952400	20001214
Uni-Vent Rapid Ridge/Hip (10m)	931300	10002813
Uni-Vent Rapid Hip Support Tray (10 x 1.2m)	906900	20001084
Third Round Hip/Ridge Junction	952100	20001212
Bonnet Hip Tile 35°-50° Autumn	767123	10002268
Bonnet Hip Tile 35°-50° Wealden Red	767122	10002267
Third Round Hip (without nail holes) Autumn	768623	10002297
Third Round Hip (without nail holes) Wealden Red	768622	10002296
Third Round Hip (with nail holes) Autumn	768723	10002302
Third Round Hip (with nail holes) Wealden Red	768722	10002301
Third Round Hip Block-End Autumn	768823	10002306
Baby Ridge Autumn	767523	10002288
Baby Ridge Wealden Red	767522	10002287
Mortar Bedded Fixing Kit	931400	10002814

Fittings and components continued >



VALLEY PRODUCTS	Previous code	Code
GRP 125 Valley (3m)	959500	20001231
Dry Valley (High Profile) (3m)	957400	20001224
Valley Tile 35° - 50° Autumn	767223	10002273
Valley Tile 35° - 50° Wealden Red	767222	10002272
ABUTMENT PRODUCTS		
Top Edge Abutment Ventilation (3m)	954800	10002838
Wakaflex Rapid Flashing (see pages 148-149)		
Bonding Strip (High Profile) (3m)	957800	20001226
RIDGE PRODUCTS		
DryVent Ridge (2.7m)	905800	10002747
Uni-Vent Rapid Ridge/Hip (10m)	931300	10002813
Continuous Ridge (5m)	930200	10002809
Half Round Ridge Autumn	769023	10002310
Half Round Ridge Wealden Red	769022	10002309
DryVent Monoridge (2.7m)	908400	10002753
Half Round Monoridge Autumn	768323	10002292
Half Round Monoridge Antique Red	720303	10002071
Half Round Monoridge Natural Red	720327	10002074
Mortar Bedded Fixing Kit	931400	10002814
VENTILATION TILES		
RedLine Plain Tile Vent Autumn	911923	20001124
RedLine Plain Tile Vent Natural Red	911927	20001126
RedLine Plain Tile Vent Antique Red	911903	20001120
RedLine Vent Adaptor	917500	10002798
EXTERNAL VERTICAL ANGLES		
External Angle 90° LH Autumn	767323	10002278
External Angle 90° LH Wealden Red	767322	10002277
External Angle 90° RH Autumn	767423	10002283
External Angle 90° RH Wealden Red	767422	10002282
FIXING		
Tile Nail (Alum. Alloy) (approx 1596)	933100	20001172
Top Tile Clip (100)	928200	20001398
Kro-Clip (50)	914200	10003245
ORNAMENTAL TILES		
Heathland Club Tile Autumn	667123	10001973
Heathland Club Tile Wealden Red	667122	10001972

Plain Tile

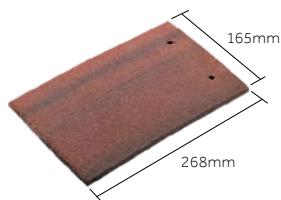

KEY FEATURES AND ADVANTAGES

- Versatile concrete tile with wide scope for a variety of roofing effects
- Quick and easy to lay
- Smooth, coated and sanded finishes available to blend with every regional roofing style

PRODUCT DETAILS

Size	268 x 165mm
Minimum pitch	35°
Maximum pitch (subject to fixing specification and fire resistance requirements above 69°)	90°
Minimum headlap	below 90° 65mm / at 90° 35mm
Maximum headlap	88mm
Minimum gauge/batten spacing	88mm
Maximum gauge/batten spacing	below 90° 100mm / at 90° 115mm
Hanging length (approx)	248mm (+/-1)
Cover (all figures are net and do not allow for wastage)	
Linear cover of 1 tile	165mm
Covering capacity	below 90° 60 tiles/m ² / at 90° 52 tiles/m ²
Weight per pallet, including pallet (approx.) per 1000	below 90° 75kg/m ² / at 90° 65kg/m ² 1.01 tonnes 1.25 tonnes
Battens required (at max. gauge)	below 90° 10.0m/m ²
Batten size Rafter centres up to 600mm	38 x 25mm
Fixing clips	Top tile clips
Nail size for tiles*	40 x 2.65mm (A/A)
Pallet quantities	Tiles per pallet 768 / tiles per pack 16 / packs per pallet 48

*(A/A) Aluminium Alloy

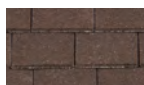

Brown
(granular)

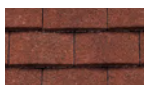

Antique Red
(granular)

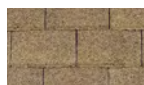

Cotswold
(granular)

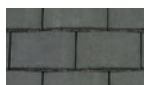

Slate Grey

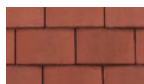

Terracotta

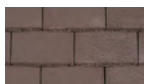

Tudor Brown

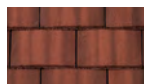

Farmhouse Red

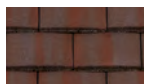

Breckland Brown



Natural Red
(sanded)

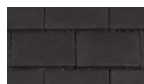

Black
(coated)



Charcoal Grey
(Coated)

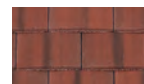

Rustic Red
(Coated)



PLAIN TILE

CONCRETE

PRODUCT CODES

TILES	Previous code	Code
Plain Tile Brown	615102	10001872
Plain Tile Cotswold	615112	10001874
Plain Tile Antique Red	615103	10001873
Plain Tile Natural Red	615127	10001876
Plain Tile Breckland Brown	615152	10001882
Plain Tile Slate Grey	615130	10001877
Plain Tile Terracotta	615134	10001879
Plain Tile Tudor Brown	615136	10001880
Plain Tile Farmhouse Red	615139	10001881
Plain Tile Charcoal Grey	615177	10001884
Plain Tile Black	615163	10001883
Plain Tile Rustic Red	615178	10001885
Eaves/Top Tile Brown	615402	10001886
Eaves/Top Tile Cotswold	615412	10001888
Eaves/Top Tile Antique Red	615403	10001887
Eaves/Top Tile Natural Red	615427	10001890
Eaves/Top Tile Breckland Brown	615452	10001895
Eaves/Top Tile Slate Grey	615430	10001891
Eaves/Top Tile Terracotta	615434	10001892
Eaves/Top Tile Tudor Brown	615436	10001893
Eaves/Top Tile Farmhouse Red	615439	10001894
Eaves/Top Tile Charcoal Grey	615477	10001897
Eaves/Top Tile Black	615463	10001896
Eaves/Top Tile Rustic Red	615478	10001898
Tile-and-a-half Brown	615902	10001899
Tile-and-a-half Cotswold	615912	10001901
Tile-and-a-half Antique Red	615903	10001900
Tile-and-a-half Natural Red	615927	10001903
Tile-and-a-half Breckland Brown	615952	10001908
Tile-and-a-half Slate Grey	615930	10001904
Tile-and-a-half Terracotta	615934	10001905
Tile-and-a-half Tudor Brown	615936	10001906
Tile-and-a-half Farmhouse Red	615939	10001907
Tile-and-a-half Charcoal Grey	615977	10001910
Tile-and-a-half Black	615963	10001909
Tile-and-a-half Rustic Red	615978	10001911

Fittings and components continued >

UNDERLAYS	Previous code	Code
Divoroll Elite 200 2S	915700	10002797
Divoroll Universal 2S	915600	10002796
EAVES PRODUCTS		
Rapid EavesVent 2-in-1 Tray	998800	20001276
Rapid EavesVent Rafter Roll (6m)	998400	20001275
RedVent 25 Over-Fascia Vent (6m)	959300	20001230
Underlay Support Tray (1.5m)	907600	20001461
HIP PRODUCTS		
Continuous Hip (5m)	952400	20001214
Uni-Vent Rapid Ridge/Hip (10m)	931300	10002813
Uni-Vent Rapid Hip Support Tray (10 x 1.2m)	906900	20001084
Third Round Hip/Ridge Junction	952100	20001212
Bonnet Hip Tile 35°-50° Brown	812502	10002496
Bonnet Hip Tile 35°-50° Cotswold	812512	10002498
Bonnet Hip Tile 35°-50° Antique Red	812503	10002497
Bonnet Hip Tile 35°-50° Natural Red	812527	10002500
Bonnet Hip Tile 35°-50° Slate Grey	812530	10002501
Bonnet Hip Tile 35°-50° Terracotta	812534	10002502
Bonnet Hip Tile 35°-50° Tudor Brown	812536	10002503
Bonnet Hip Tile 35°-50° Charcoal Grey	-	11000187
Bonnet Hip Tile 35°-50° Black	812563	10002504
Bonnet Hip Tile 35°-50° Rustic Red	812578	10002505
Third Round Hip (without nail holes) Brown	812202	10002486
Third Round Hip (without nail holes) Cotswold	812212	10002488
Third Round Hip (without nail holes) Antique Red	812203	10002487
Third Round Hip (without nail holes) Natural Red	812227	10002490
Third Round Hip (without nail holes) Slate Grey	812230	10002491
Third Round Hip (without nail holes) Terracotta	812234	10002492
Third Round Hip (without nail holes) Tudor Brown	812236	10002493
Third Round Hip (without nail holes) Charcoal Grey	821277	10002556
Third Round Hip (without nail holes) Black	812263	10002494
Third Round Hip (without nail holes) Rustic Red	812278	10002495
Third Round Hip (with nail holes) Brown	741102	10002212
Third Round Hip (with nail holes) Cotswold	741112	10002214
Third Round Hip (with nail holes) Antique Red	741103	10002213
Third Round Hip (with nail holes) Natural Red	741127	10002216
Third Round Hip (with nail holes) Slate Grey	741130	10002217
Third Round Hip (with nail holes) Terracotta	741134	10002218
Third Round Hip (with nail holes) Tudor Brown	741136	10002219
Third Round Hip (with nail holes) Charcoal Grey	821177	10002550
Third Round Hip (with nail holes) Black	741163	10002220
Third Round Hip (with nail holes) Rustic Red	741178	10002221
Third Round Block End Hip Brown	778402	10002370
Third Round Block End Hip Cotswold	778412	10002372
Third Round Block End Hip Antique Red	778403	10002371

HIP PRODUCTS CONTINUED	Previous code	Code
Third Round Block End Hip Natural Red	778427	10002374
Third Round Block End Hip Slate Grey	778430	10002375
Third Round Block End Hip Terracotta	778434	10002376
Third Round Block End Hip Tudor Brown	778436	10002377
Third Round Block End Hip Charcoal Grey	740477	10002200
Third Round Block End Hip Black	778463	10002378
Third Round Block End Hip Rustic Red	778478	10002379
Baby Ridge Brown	710702	10002008
Baby Ridge Cotswold	710712	10002010
Baby Ridge Antique Red	710703	10002009
Baby Ridge Natural Red	710727	10002012
Baby Ridge Slate Grey	710730	10002013
Baby Ridge Terracotta	710734	10002015
Baby Ridge Tudor Brown	710736	10002016
Baby Ridge Charcoal Grey	740877	10002204
Baby Ridge Black	710763	10002017
Baby Ridge Rustic Red	710778	10002019
Pascal Roll Slate Grey	712630	10002021
Pascal Roll Terracotta	712634	10002022
Pascal Roll Black	712663	10002023
Hip End Cap Third Round Terracotta	971234	10002850
Hip End Cap Third Round Brown	971236	10002851
Hip End Cap Third Round Black	971263	10002852
Mortar Bedded Fixing Kit	931400	10002814
VALLEY PRODUCTS		
GRP 125 Valley (3m)	959500	20001231
Dry Valley (High Profile) (3m)	957400	20001224
Valley Tile 35° - 50° Brown	813302	10002506
Valley Tile 35° - 50° Cotswold	813312	10002508
Valley Tile 35° - 50° Antique Red	813303	10002507
Valley Tile 35° - 50° Natural Red	813327	10002510
Valley Tile 35° - 50° Slate Grey	813330	10002511
Valley Tile 35° - 50° Terracotta	813334	10002512
Valley Tile 35° - 50° Tudor Brown	813336	10002513
Valley Tile 35° - 50° Charcoal Grey	-	11000188
Valley Tile 35° - 50° Black	813363	10002514
Valley Tile 35° - 50° Rustic Red	813378	10002515
ABUTMENT PRODUCTS		
Top Edge Abutment Ventilation (3m)	954800	10002838
Wakaflex Rapid Flashing (see pages 148-149)		
Bonding Strip (High Profile) (3m)	957800	20001226
RIDGE PRODUCTS		
DryVent Ridge (1.8m)	905800	10002747
Uni-Vent Rapid Ridge/Hip (10m)	931300	10002813
Continuous Ridge (5m)	930200	10002809

RIDGE PRODUCTS CONTINUED	Previous code	Code
Half Round Ridge Brown	810102	10002476
Half Round Ridge Cotswold	810112	10002478
Half Round Ridge Antique Red	810103	10002477
Half Round Ridge Natural Red	810127	10002480
Half Round Ridge Slate Grey	810130	10002481
Half Round Ridge Terracotta	810134	10002482
Half Round Ridge Tudor Brown	810136	10002483
Half Round Ridge Charcoal Grey	820177	10002544
Half Round Ridge Black	810163	10002484
Half Round Ridge Rustic Red	810178	10002485
Half Round Ridge Block-End Brown	751902	10002244
Half Round Ridge Block-End Antique Red	751903	10002245
Half Round Ridge Block-End Cotswold	751912	10002246
Half Round Ridge Block-End Slate Grey	751930	10002249
Half Round Ridge Block-End Terracotta	751934	10002250
Half Round Ridge Block-End Tudor Brown	751936	10002251
Half Round Ridge Block-End Natural Red	751927	10002248
Half Round Ridge Block-End Black	751963	10002252
Half Round Ridge Block-End Charcoal Grey	740977	10002210
Half Round Ridge Block-End Rustic Red	751978	10002253
DryVent Monoridge (2.7m)	908400	10002753
Half Round Monoridge Brown	720302	10002070
Half Round Monoridge Cotswold	720312	10002072
Half Round Monoridge Antique Red	720303	10002071
Half Round Monoridge Natural Red	720327	10002074
Half Round Monoridge Slate Grey	720330	10002075
Half Round Monoridge Terracotta	720334	10002076
Half Round Monoridge Tudor Brown	720336	10002077
Half Round Monoridge Charcoal Grey	740377	10002194
Half Round Monoridge Black	720363	10002078
Half Round Monoridge Rustic Red	720378	10002079
Mortar Bedded Fixing Kit	931400	10002814
VENTILATION TILES		
RedLine Plain Tile Vent Brown	911902	20001119
RedLine Plain Tile Vent Cotswold	911912	20001121
RedLine Plain Tile Vent Antique Red	911903	20001120
RedLine Plain Tile Vent Black	911963	20001130
RedLine Plain Tile Vent Rustic Red	911978	20001131
RedLine Plain Tile Vent Slate Grey	911930	20001127
RedLine Plain Tile Vent Terracotta	911934	20001128
RedLine Plain Tile Vent Tudor Brown	911936	20001129
RedLine Plain Tile Vent Natural Red	911927	20001126
RedLine Vent Adaptor	917500	10002798
Plain Tile Rapid Roof Vent Brown	912836	10002789
Plain Tile Rapid Roof Vent Grey	912830	10002787

VENTILATION TILES CONTINUED	Previous code	Code
Plain Tile Rapid Roof Vent Terracotta	912834	10002788
Plain Tile Rapid Roof Vent Dark Brown	912802	10002785
Plain Tile Rapid Roof Vent Red	912803	10002786
Rapid Roof Vent Adaptor	917500	10002798
Flexible Pipe (100 to 100mm)	917200	20001149
EXTERNAL VERTICAL ANGLES		
External Angle 90° LH Brown	813402	10002516
External Angle 90° LH Cotswold	813412	10002518
External Angle 90° LH Antique Red	813403	10002517
External Angle 90° LH Natural Red	813427	10002520
External Angle 90° LH Breckland Brown	813452	10002525
External Angle 90° LH Slate Grey	813430	10002521
External Angle 90° LH Terracotta	813434	10002522
External Angle 90° LH Tudor Brown	813436	10002523
External Angle 90° LH Farmhouse Red	813439	10002524
External Angle 90° LH Black	813463	10002526
External Angle 90 LH Charcoal Grey	-	11000125
External Angle 90° LH Rustic Red	813478	10002527
External Angle 90° RH Brown	813502	10002528
External Angle 90° RH Cotswold	813512	10002530
External Angle 90° RH Antique Red	813503	10002529
External Angle 90° RH Natural Red	813527	10002532
External Angle 90° RH Breckland Brown	813552	10002537
External Angle 90° RH Slate Grey	813530	10002533
External Angle 90° RH Terracotta	813534	10002534
External Angle 90° RH Tudor Brown	813536	10002535
External Angle 90° RH Farmhouse Red	813539	10002536
External Angle 90° RH Black	813563	10002538
External Angle 90 RH Charcoal Grey	-	11000124
External Angle 90° RH Rustic Red	813578	10002539
FIXING		
Tile Nail (Alum. Alloy) (approx 1596)	933100	20001172
Top Tile Clip (100)	928200	20001398
Kro-Clip (50)	914200	10003245
ORNAMENTAL TILES		
Plain Tile Club Tile Brown	625102	10001913
Plain Tile Club Tile Cotswold	625112	10001915
Plain Tile Club Tile Antique Red	625103	10001914
Plain Tile Club Tile Natural Red	625127	10001917
Plain Tile Club Tile Breckland Brown	625152	10001923
Plain Tile Club Tile Slate Grey	625130	10001918
Plain Tile Club Tile Terracotta	625134	10001920
Plain Tile Club Tile Tudor Brown	625136	10001921
Plain Tile Club Tile Farmhouse Red	625139	10001922
Plain Tile Club Tile Rustic Red	625178	10001924

DuoPlain

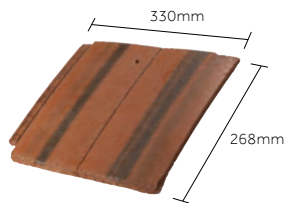

KEY FEATURES AND ADVANTAGES

- Two 'plain tile' segments give the appearance of a smaller format tile
- Quick and cost-effective to lay
- Four colour variations to match regional styles and materials



DUOPLAIN

CONCRETE

PRODUCT DETAILS

Size	268 x 330mm
Minimum pitch	25°
(The minimum pitch is based on a maximum rafter length of 10 metres. For rafter lengths greater than this, please contact Technical Services on 0330 123 4585)	
Maximum pitch (subject to fixing specification and fire resistance requirements above 69°)	90°
Minimum headlap	80mm
Maximum headlap	95mm
Minimum gauge/batten spacing	173mm
Maximum gauge/batten spacing	188mm
Hanging length (approx)	245mm
Cover (all figures are net and do not allow for wastage)	
Linear cover of 1 tile	300mm
Covering capacity	17.7 tiles/m ² / (at 188mm gauge)
Weight	54kg/m ² (at 188mm gauge)
per pallet, including pallet (approx.)	0.90 tonnes
per 1000	3.04 tonnes
Battens required (at max. gauge)	5.26m/m ²
Batten size	
Rafter centres up to 450mm	38 x 25mm
Rafter centres up to 600mm	50 x 25mm
Nail size for tiles* (Depending on fixing specification)	45 x 3mm (A/A) or 45 x 3.35mm (S/S)
Pallet quantities	Tiles per pallet 288 / tiles per pack 6 / packs per pallet 48

*(A/A) Aluminium Alloy (S/S) Stainless Steel Ring Shank

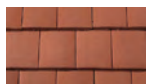

Tuscan Red
(coated)

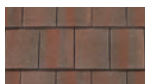

Rustic Brown
(coated)

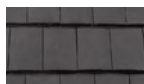

Charcoal Grey
(coated)

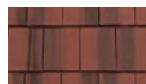

Rustic Red
(coated)

PRODUCT CODES

TILES	Previous code	Code
DuoPlain Tile Charcoal Grey	610177	10001856
DuoPlain Tile Rustic Brown	610140	10001854
DuoPlain Tile Rustic Red	610178	10001857
DuoPlain Tile Tuscan Red	610111	10001853
DuoPlain Half Tile Charcoal Grey	610577	10001869
DuoPlain Half Tile Rustic Brown	610540	10001868
DuoPlain Half Tile Rustic Red	610578	10001870
DuoPlain Half Tile Tuscan Red	610511	10001867
DuoPlain LH Verge Tile Charcoal Grey	610377	10001861
DuoPlain LH Verge Tile Rustic Brown	610340	10001859
DuoPlain LH Verge Tile Rustic Red	610378	10001862
DuoPlain LH Verge Tile Tuscan Red	610311	10001858
DuoPlain RH Verge Tile Charcoal Grey	610477	10001865
DuoPlain RH Verge Tile Rustic Brown	610440	10001864
DuoPlain RH Verge Tile Rustic Red	610478	10001866
DuoPlain RH Verge Tile Tuscan Red	610411	10001863
UNDERLAYS		
Divoroll Elite 200 2S	915700	10002797
Divoroll Universal 2S	915600	10002796
EAVES PRODUCTS		
Rapid EavesVent 2-in-1 Tray	998800	20001276
Rapid EavesVent Rafter Roll (6m)	998400	20001275
RedVent 25 Over-Fascia Vent (6m)	959300	20001230
Underlay Support Tray (1.5m)	907600	20001461
VERGE PRODUCTS		
DuoPlain DryVerge Terracotta (36)	991634	10002880
DuoPlain DryVerge Brown (36)	991636	10002881
DuoPlain DryVerge Charcoal Grey (36)	991677	10002882
DuoPlain DryVerge Red (36)	991678	10002883
DuoPlain DryVerge Gable End Pack Terracotta	927334	10002805
DuoPlain DryVerge Gable End Pack Brown	927336	10002806
DuoPlain DryVerge Gable End Pack Charcoal Grey	927377	10002807
DuoPlain DryVerge Gable End Pack Red	927378	10002808

Fittings and components continued >

HIP PRODUCTS	Previous code	Code
Continuous Hip (5m)	956200	20001220
Uni-Vent Rapid Ridge/Hip (10m)	931300	10002813
Uni-Vent Rapid Hip Support Tray (10 x 1.2m)	906900	20001084
Third Round Hip/Ridge Junction	952100	20001212
Third Round Hip (without nail holes) Rustic Brown	821235	10002553
Third Round Hip (without nail holes) Rustic Red	821278	10002557
Third Round Hip (without nail holes) Red	821211	10002552
Third Round Hip (without nail holes) Charcoal Grey	821277	10002556
Third Round Hip (with nail holes) Rustic Brown	821135	10002547
Third Round Hip (with nail holes) Rustic Red	821178	10002551
Third Round Hip (with nail holes) Red	821111	10002546
Third Round Hip (with nail holes) Charcoal Grey	821177	10002550
DuoPlain Third Round Block End Hip Rustic Brown	740435	10002197
DuoPlain Third Round Block End Hip Rustic Red	740478	10002201
DuoPlain Third Round Block End Hip Red	740411	10002196
Third Round Block End Hip Charcoal Grey	740477	10002200
DuoPlain Baby Ridge Charcoal Grey	740877	10002204
DuoPlain Baby Ridge Rustic Brown	740835	10002203
DuoPlain Baby Ridge Rustic Red	740878	10002205
DuoPlain Baby Ridge Red	740811	10002202
Mortar Bedded Fixing Kit	931400	10002814

VALLEY PRODUCTS	Previous code	Code
GRP 125 Valley (3m)	959500	20001231
Dry Valley (High Profile) (3m)	957500	20001225
ABUTMENT PRODUCTS		
Top Edge Abutment Ventilation (3m)	954800	10002838
Wakaflex Rapid Flashing (see pages 148-149)		
Bonding Strip (Low Profile) (3m)	958000	20001227
Bonding Strip (High Profile) (3m)	957800	20001226
GRP Secret Gutter	959600	20001232
RIDGE PRODUCTS		
DryVent Ridge (2.7m)	905800	10002747
Uni-Vent Rapid Ridge/Hip (10m)	931300	10002813
Continuous Ridge (5m)	930200	10002809
Half Round Ridge Rustic Brown	820135	10002541
Half Round Ridge Rustic Red	820178	10002545
Half Round Ridge Red	820111	10002540
Half Round Ridge Charcoal Grey	820177	10002544
Half Round Block-End Ridge Rustic Brown	740935	10002207
Half Round Block-End Ridge Rustic Red	740978	10002211
Half Round Block-End Ridge Red	740911	10002206
Half Round Block-End Ridge Charcoal Grey	740977	10002210
DryVent Monoridge (2.7m)	908400	10002753
DuoPlain Half Round Monoridge Rustic Brown	740335	10002192
DuoPlain Half Round Monoridge Rustic Red	740378	10002195
DuoPlain Half Round Monoridge Red	740311	10002191
Half Round Monoridge Charcoal Grey	740377	10002194
Mortar Bedded Fixing Kit	931400	10002814
VENTILATION TILES		
DuoPlain RedLine Vent Charcoal Grey	911377	10002764
DuoPlain RedLine Vent Rustic Brown	911340	10002762
DuoPlain RedLine Vent Rustic Red	911378	10002765
DuoPlain RedLine Vent Red	911338	10002761
Flexible Pipe (100 to 100mm)	917200	20001149
FIXING		
Verge Clip (100)	919800	20001161
Eaves Clip (100)	918400	20001153
Tile Nail (Alum. Alloy) (1060)	933400	20001174
Tile Nail (Stainless Steel) (300)	935000	20001178
Eaves Clip Nail (812)	933800	20001177
Kro-Clip (50)	914200	10003245
Innofix Clip Purple (250)	-	11000229
Screw (Stainless Steel) (100)	910400	20001087



Profile Tile Range

Based on 16th century pantiles from Holland and earlier Roman roofing, the flowing contours and distinctive angular patterns of the profile range create roofs with outstanding visual appeal and dependable weathertightness.

The tiles in the BMI Redland profile range have been carefully selected to reflect the vast variety of profile roofing in use across the UK & Ireland, from traditional handmade styles right up to contemporary designs for today's urban landscape.

These precision-made interlocking concrete tiles come in a wide variety of colours and finishes. As well as their aesthetic appeal, these tiles are designed for speed and ease of installation.

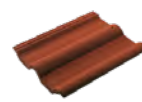

Grovebury

50 Double Roman

Regent

Page no.	66-69	70-73	74-77
Min. pitch	15°	17.5°	12.5°
Weight*	46kg/m ²	41kg/m ²	43kg/m ²
Cover*	9.7 tiles/m ²	9.7 tiles/m ²	9.7 tiles/m ²

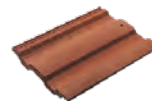

Renown

Redland 49

Fenland Pantile

Page no.	78-81	82-85	86-89
Min. pitch	17.5°	17.5°	17.5°
Weight*	40kg/m ²	47kg/m ²	42kg/m ²
Cover*	9.7 tiles/m ²	16.3 tiles/m ²	16.3 tiles/m ²

* Depends on headlap used. Refer to product pages for full technical information.

Grovebury



KEY FEATURES AND ADVANTAGES

- Traditional double pantile profile blends with a wide range of roofing styles
- Quick to lay, saving time and money during installation
- Wide variety of colours and surface textures

PRODUCT DETAILS

Size (overall)	418 x 332mm
Minimum pitch and headlap	15° at 100mm headlap / 17.5° at 75mm headlap
Maximum pitch (subject to fixing specification and fire resistance requirements above 69°)	90°
Maximum headlap	125mm
Minimum gauge/batten spacing	293mm
Maximum gauge/batten spacing	below 17.5° at 318mm / 17.5° and over 343mm
Hanging length (approx)	397mm
Cover (all figures are net and do not allow for wastage)	
Linear cover of 1 tile	300mm
Covering capacity	10.5 tiles/m ² at 318mm gauge / 9.7 tiles/m ² at 343mm gauge
Weight	50kg/m ² at 318mm gauge / 46kg/m ² at 343mm gauge
per pallet, including pallet (approx.)	1.08 tonnes
per 1000	4.75 tonnes
Battens required (at max. gauge)	2.92m/m ²
Batten size	
Rafter centres up to 450mm	38 x 25mm
Rafter centres up to 600mm	50 x 25mm
Fixing clips	Eaves, verge & tile clips
Nail size for tiles*	70 x 3.75mm (A/A)
Pallet quantities	Tiles per pallet 216 / tiles per pack 36 / packs per pallet 6

*(A/A) Aluminium Alloy

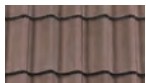

Tudor Brown



Slate Grey

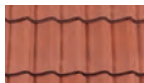

Terracotta

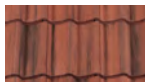

Farmhouse Red

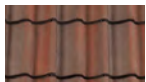

Breckland Brown

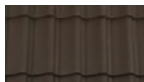

Charcoal Grey
(coated)



GROVEBURY

CONCRETE

PRODUCT CODES

TILES	Previous code	Code
Grovebury Tile Breckland Brown	574152	10003067
Grovebury Tile Slate Grey	574130	10003063
Grovebury Tile Terracotta	574134	10003064
Grovebury Tile Tudor Brown	574136	10003065
Grovebury Tile Farmhouse Red	574139	10003066
Grovebury Tile Charcoal Grey	574177	10001819
UNDERLAYS		
Divoroll Elite 200 2S	915700	10002797
Divoroll Universal 2S	915600	10002796
EAVES PRODUCTS		
Rapid EavesVent 2-in-1 Tray	998800	20001276
Rapid EavesVent Rafter Roll (6m)	998400	20001275
RedVent 25 Over-Fascia Vent (6m)	959300	20001230
Underlay Support Tray (1.5m)	-	20001461
Eaves Comb Filler (1m)	996500	10002894
VERGE PRODUCTS		
Grovebury LH Cloaked Verge Breckland Brown	727352	10002125
Grovebury LH Cloaked Verge Slate Grey	727330	10002121
Grovebury LH Cloaked Verge Terracotta	727334	10002122
Grovebury LH Cloaked Verge Tudor Brown	727336	10002123
Grovebury LH Cloaked Verge Farmhouse Red	727339	10002124
Grovebury RH Cloaked Verge Breckland Brown	727452	10002134
Grovebury RH Cloaked Verge Slate Grey	727430	10002130
Grovebury RH Cloaked Verge Terracotta	727434	10002131
Grovebury RH Cloaked Verge Tudor Brown	727436	10002132
Grovebury RH Cloaked Verge Farmhouse Red	727439	10002133
Grovebury Half Tile Breckland Brown	777052	10002349
Grovebury Half Tile Slate Grey	777030	10002345
Grovebury Half Tile Terracotta	777034	10002346
Grovebury Half Tile Tudor Brown	777036	10002347
Grovebury Half Tile Farmhouse Red	777039	10002348
DryVerge (Pack of 18 LH & 18 RH) Charcoal Grey	939077	10003123
DryVerge (Pack of 18 LH & 18 RH) Slate Grey	939030	10003217
DryVerge (Pack of 18 LH & 18 RH) Terracotta	939034	10003121
DryVerge (Pack of 18 LH & 18 RH) Brown	939036	10003122

Fittings and components continued >

FITTINGS AND COMPONENTS

VERGE PRODUCTS CONTINUED	Previous code	Code
DryVerge Gable End Pack Charcoal Grey	988077	10002866
DryVerge Gable End Pack Slate Grey	988030	10002863
DryVerge Gable End Pack Terracotta	988034	10002864
DryVerge Gable End Pack Brown	988036	10002865
Rapid DryVerge (Pack of 18LH & 18RH) Slate Grey	939130	10002821
Rapid DryVerge (Pack of 18LH & 18RH) Rust	939155	10002822
Rapid DryVerge (Pack of 18LH & 18RH) Charcoal Grey	939177	10002823
Rapid DryVerge Gable End Pack Slate Grey	988130	10002869
Rapid DryVerge Gable End Pack Rust	988155	10002870
Rapid DryVerge Gable End Pack Charcoal Grey	988177	10002871
HIP PRODUCTS		
Continuous Hip (5m)	902800	20001082
Third Round Hip/Ridge Junction	952100	20001212
Uni-Vent Rapid Ridge/Hip (10m)	931300	10002813
Uni-Vent Rapid Hip Support Tray (10 x 1.2m)	906900	20001084
Third Round Hip (without nail holes) Slate Grey	812230	10002491
Third Round Hip (without nail holes) Terracotta	812234	10002492
Third Round Hip (without nail holes) Tudor Brown	812236	10002493
Third Round Hip (without nail holes) Black	812263	10002494
Third Round Hip (without nail holes) Charcoal Grey	821277	10002556
Third Round Hip (with nail holes) Slate Grey	741130	10002217
Third Round Hip (with nail holes) Terracotta	741134	10002218
Third Round Hip (with nail holes) Tudor Brown	741136	10002219
Third Round Hip (with nail holes) Black	741163	10002220
Third Round Hip (with nail holes) Charcoal Grey	821177	10002550
Third Round Block End Hip Slate Grey	778430	10002375
Third Round Block End Hip Terracotta	778434	10002376
Third Round Block End Hip Tudor Brown	778436	10002377
Third Round Block End Hip Black	778463	10002378
Third Round Block End Hip Charcoal Grey	740477	10002200
Hip End Cap Third Round Terracotta	971234	10002850
Hip End Cap Third Round Brown	971236	10002851
Hip End Cap Third Round Black	971263	10002852
Mortar Bedded Fixing Kit	931400	10002814
VALLEY PRODUCTS		
GRP 125 Valley (3m)	959500	20001231
Dry Valley (High Profile) (3m)	957400	20001224
ABUTMENT PRODUCTS		
Top Edge Abutment Ventilation (3m)	954100	10002834
Wakaflex Rapid Flashing (see pages 148-149)		
Bonding Strip (High Profile) (3m)	957800	20001226
RIDGE PRODUCTS		
DryVent Ridge (2.7m)	909400	10002755
Uni-Vent Rapid Ridge/Hip (10m)	931300	10002813
Continuous Ridge (5m)	930400	10002810
Half Round Ridge Slate Grey	810130	10002481
Half Round Ridge Terracotta	810134	10002482
Half Round Ridge Tudor Brown	810136	10002483

RIDGE PRODUCTS CONTINUED	Previous code	Code
Half Round Ridge Black	810163	10002484
Half Round Ridge Charcoal Grey	820177	10002544
Half Round Block End Ridge Slate Grey	751930	10002249
Half Round Block End Ridge Terracotta	751934	10002250
Half Round Block End Ridge Tudor Brown	751936	10002251
Half Round Block End Ridge Black	751963	10002252
Half Round Block End Ridge Charcoal Grey	740977	10002210
DryVent Monoridge (2.7m)	908000	10002750
Half Round Monoridge Charcoal Grey	740377	10002194
Half Round Monoridge Slate Grey	720330	10002075
Half Round Monoridge Terracotta	720334	10002076
Half Round Monoridge Tudor Brown	720336	10002077
Half Round Monoridge Black	720363	10002078
Monoridge End Cap Half Round LH Rust	976355	20001385
Monoridge End Cap Half Round LH Slate Grey	976330	20001384
Monoridge End Cap Half Round RH Rust	976455	20001387
Monoridge End Cap Half Round RH Slate Grey	976430	20001386
Mortar Bedded Fixing Kit	931400	10002814
Ridge End Cap Half Round Slate Grey	977230	20001251
Ridge End Cap Half Round Rust	977255	20001252
VENTILATION TILES		
Grovebury RedLine Vent Charcoal Grey	911477	20001094
Grovebury RedLine Vent Farmhouse Red	911459	20001092
Grovebury RedLine Vent Breckland Brown	911452	20001093
Grovebury RedLine Vent Slate Grey	911430	20001089
Grovebury RedLine Vent Terracotta	911434	20001090
Grovebury RedLine Vent Tudor Brown	911436	20001091
8.8k ThruVent Breckland Brown	793152	10002435
8.8k ThruVent Slate Grey	793130	10002431
8.8k ThruVent Terracotta	793134	10002432
8.8k ThruVent Tudor Brown	793136	10002433
8.8k ThruVent Farmhouse Red	793139	10002434
Flexible Pipe (100 to 100mm)	917200	20001149
Grovebury Rapid Roof Vent Brown	912636	10002780
Grovebury Rapid Roof Vent Terracotta	912634	10002779
Grovebury Rapid Roof Vent Grey	912630	10002778
Grovebury Rapid Roof Vent Red	-	11000228
Rapid Roof Vent Adaptor	979100	10002861
FIXING		
Tile Clip	924600	20001162
Verge Clip LH	912100	20001392
Verge Clip RH	929800	20001401
Eaves Clip inc Nail	928700	10003246
Tile Clip Nail (680)	933300	20001173
Tile Nail (460)	933600	20001175
Kro-Clip (50)	914200	10003245
Innofix Clip Red (250)	-	11000253

50 Double Roman

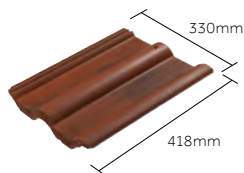

KEY FEATURES AND ADVANTAGES

- Recreates look of classic clay Roman roof
- Six colours to provide match with every regional roofing style
- Compatible with a wide range of fittings and accessories

PRODUCT DETAILS

Size (overall)	418 x 330mm
Minimum pitch and headlap	17.5° at 100mm headlap / 22.5° at 75mm headlap
Maximum pitch (subject to fixing specification and fire resistance requirements above 69°)	90°
Maximum headlap	125mm
Minimum gauge/batten spacing	293mm
Maximum gauge/batten spacing	below 22.5° at 318mm / 22.5° and over 343mm
Hanging length (approx)	397mm
Cover (all figures are net and do not allow for wastage)	
Linear cover of 1 tile	300mm
Covering capacity	10.5 tiles/m ² at 318mm gauge / 9.7 tiles/m ² at 343mm gauge
Weight per pallet, including pallet (approx.) per 1000	44kg/m ² at 318mm gauge / 41kg/m ² at 343mm gauge 1.11 tonnes 4.19 tonnes
Battens required (at max. gauge)	2.92m/m ²
Batten size	
Rafter centres up to 450mm	38 x 25mm
Rafter centres up to 600mm	50 x 25mm
Fixing clips	Eaves, verge & tile clips
Nail size for tiles*	60 x 3.35mm (A/A)
Pallet quantities	Tiles per pallet 252 / tiles per pack 42 / packs per pallet 6

*(A/A) Aluminium Alloy

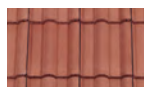

Terracotta



Rustic Red
(coated)



Slate Grey

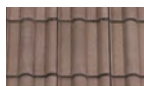

Tudor Brown

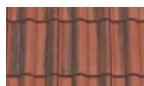

Farmhouse Red

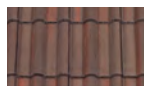

Breckland Brown



50 DOUBLE ROMAN

CONCRETE

PRODUCT CODES

TILES	Previous code	Code
50 Double Roman Tile Breckland Brown	220152	10001719
50 Double Roman Tile Slate Grey	220130	10003045
50 Double Roman Tile Terracotta	220134	10003046
50 Double Roman Tile Tudor Brown	220136	10003047
50 Double Roman Tile Farmhouse Red	220139	10003048
50 Double Roman Tile Rustic Red	220178	10001721
UNDERLAYS		
Divoroll Elite 200 2S	915700	10002797
Divoroll Universal 2S	915600	10002796
EAVES PRODUCTS		
Rapid EavesVent 2-in-1 Tray	998800	20001276
Rapid EavesVent Rafter Roll (6m)	998400	20001275
RedVent 25 Over-Fascia Vent (5m)	959300	20001230
Underlay Support Tray (1.5m)	907600	20001461
VERGE PRODUCTS		
LH Cloaked Verge Breckland Brown	727552	10002143
LH Cloaked Verge Slate Grey	727530	10002139
LH Cloaked Verge Terracotta	727534	10002140
LH Cloaked Verge Tudor Brown	727536	10002141
LH Cloaked Verge Farmhouse Red	727539	10002142
LH Cloaked Verge Rustic Red	727578	10002144
RH Cloaked Verge Breckland Brown	727652	10002151
RH Cloaked Verge Slate Grey	727630	10002147
RH Cloaked Verge Terracotta	727634	10002148
RH Cloaked Verge Tudor Brown	727636	10002149
RH Cloaked Verge Farmhouse Red	727639	10002150
RH Cloaked Verge Rustic Red	727678	10002152
50 Double Roman Half Tile Breckland Brown	773052	10002335
50 Double Roman Half Tile Slate Grey	773030	10002331
50 Double Roman Half Tile Terracotta	773034	10002332
50 Double Roman Half Tile Tudor Brown	773036	10002333
50 Double Roman Half Tile Farmhouse Red	773039	10002334
50 Double Roman Half Tile Rustic Red	773078	10002336

Fittings and components continued >

FITTINGS AND COMPONENTS

50 Double Roman

VERGE PRODUCTS CONTINUED	Previous code	Code
DryVerge (Pack of 18 LH & 18 RH) Slate Grey	939030	10003217
DryVerge (Pack of 18 LH & 18 RH) Terracotta	939034	10003121
DryVerge (Pack of 18 LH & 18 RH) Brown	939036	10003122
DryVerge (Pack of 18 LH & 18 RH) Red	939078	10003247
DryVerge Gable End Pack Slate Grey	988030	10002863
DryVerge Gable End Pack Terracotta	988034	10002864
DryVerge Gable End Pack Brown	988036	10002865
DryVerge Gable End Pack Red	988078	10002867
Rapid DryVerge (pack of 18 LH & 18 RH) Slate Grey	939130	10002821
Rapid DryVerge (pack of 18 LH & 18 RH) Rust	939155	10002822
Rapid DryVerge Gable End Pack Slate Grey	988130	10002869
Rapid DryVerge Gable End Pack Rust	988155	10002870
HIP PRODUCTS		
Continuous Hip (5m)	902800	20001082
Third Round Hip/Ridge Junction	952100	20001212
Uni-Vent Rapid Ridge/Hip (10m)	931300	10002813
Uni-Vent Rapid Hip Support Tray (10 x 1.2m)	906900	20001084
Third Round Hip (without nail holes) Slate Grey	812230	10002491
Third Round Hip (without nail holes) Terracotta	812234	10002492
Third Round Hip (without nail holes) Tudor Brown	812236	10002493
Third Round Hip (without nail holes) Rustic Red	812278	10002495
Third Round Hip (with nail holes) Slate Grey	741130	10002217
Third Round Hip (with nail holes) Terracotta	741134	10002218
Third Round Hip (with nail holes) Tudor Brown	741136	10002219
Third Round Hip (with nail holes) Rustic Red	741178	10002221
Third Round Block End Hip Slate Grey	778430	10002375
Third Round Block End Hip Terracotta	778434	10002376
Third Round Block End Hip Tudor Brown	778436	10002377
Third Round Block End Hip Rustic Red	778478	10002379
Hip End Cap Third Round Terracotta	971234	10002850
Hip End Cap Third Round Brown	971236	10002851
Mortar Bedded Fixing Kit	931400	10002814
VALLEY PRODUCTS		
GRP 125 Valley (3m)	959500	20001231
Dry Valley (High Profile) (3m)	957400	20001224
ABUTMENT PRODUCTS		
Top Edge Abutment Ventilation (3m)	954300	10002836
Wakaflex Rapid Flashing (see pages 148-149)		
Bonding Strip (High Profile) (3m)	957800	20001226
RIDGE PRODUCTS		
DryVent Ridge (2.7m)	909500	10002756
Uni-Vent Rapid Ridge/Hip (10m)	931300	10002813
Continuous Ridge (5m)	930400	10002810
Half Round Ridge Slate Grey	810130	10002481

RIDGE PRODUCTS CONTINUED	Previous code	Code
Half Round Ridge Terracotta	810134	10002482
Half Round Ridge Tudor Brown	810136	10002483
Half Round Ridge Rustic Red	810178	10002485
Half Round Block End Ridge Slate Grey	751930	10002249
Half Round Block End Ridge Terracotta	751934	10002250
Half Round Block End Ridge Tudor Brown	751936	10002251
Half Round Block End Ridge Rustic Red	751978	10002253
DryVent Monoridge (2.7m)	908200	10002752
Half Round Monoridge Slate Grey	720330	10002075
Half Round Monoridge Terracotta	720334	10002076
Half Round Monoridge Tudor Brown	720336	10002077
Half Round Monoridge Rustic Red	720378	10002079
Monoridge End Cap Half Round LH Rust	976355	20001385
Monoridge End Cap Half Round LH Slate Grey	976330	20001384
Monoridge End Cap Half Round RH Rust	976455	20001387
Monoridge End Cap Half Round RH Slate Grey	976430	20001386
Mortar Bedded Fixing Kit	931400	10002814
Ridge End Cap Half Round Slate Grey	977230	20001251
Ridge End Cap Half Round Rust	977255	20001252
VENTILATION TILES		
50 Double Roman RedLine Vent Farmhouse Red	911739	20001109
50 Double Roman RedLine Vent Breckland Brown	911752	20001110
50 Double Roman RedLine Vent Rustic Red	911778	20001111
50 Double Roman RedLine Vent Slate Grey	911730	20001106
50 Double Roman RedLine Vent Terracotta	911734	20001107
50 Double Roman RedLine Vent Tudor Brown	911736	20001108
50 Double Roman 8.8k ThruVent Breckland Brown	793352	10002450
50 Double Roman 8.8k ThruVent Slate Grey	793330	10002446
50 Double Roman 8.8k ThruVent Terracotta	793334	10002447
50 Double Roman 8.8k ThruVent Tudor Brown	793336	10002448
50 Double Roman 8.8k ThruVent Farmhouse Red	793339	10002449
Flexible Pipe (100 to 100mm)	917200	20001149
50 Double Roman Rapid Roof Vent Brown	912536	10002776
50 Double Roman Rapid Roof Vent Terracotta	912534	10002775
50 Double Roman Rapid Roof Vent Red	912503	10002773
50 Double Roman Rapid Roof Vent Grey	912530	10002774
Rapid Roof Vent Adaptor	979100	10002861
FIXING		
Tile Clip	928800	20001399
Verge Clip LH	929700	20001169
Verge Clip RH	912100	20001392
Eaves Clip inc Nail	928700	10003246
Tile & Tile Clip Nail (approx 680)	933300	20001173
Kro-Clip (50)	914200	10003245
Innofix Clip Light Blue (250)	-	11000252

Regent

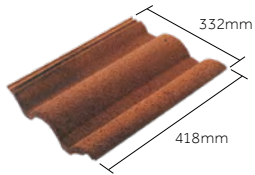

KEY FEATURES AND ADVANTAGES

- Unique high, bold roll profile
- Our lowest pitch capability tile – ideal for extensions and lean-to roofing

PRODUCT DETAILS

Size (overall)	418 x 332mm	
Minimum pitch and headlap†	12.5°† at 100mm headlap / 17.5° at 75mm headlap	
Maximum pitch (subject to fixing specification)	90°	
Maximum headlap	125mm	
Minimum gauge/batten spacing	293mm	
Maximum gauge/batten spacing	below 17.5° at 318mm / 17.5° and over 343mm	
Hanging length (approx)	397mm	
Cover (all figures are net and do not allow for wastage)		
Linear cover of 1 tile	300mm	
Covering capacity	10.5 tiles/m ² at 318mm gauge / 9.7 tiles/m ² at 343mm gauge	
Weight	46kg/m ² at 318mm gauge / 43kg/m ² at 343mm gauge	
per pallet, including pallet (approx.)	1.18 tonnes	
per 1000	4.43 tonnes	
Battens required (at max. gauge)	2.92m/m ²	
Batten size		
Rafter centres up to 450mm	38 x 25mm	
Rafter centres up to 600mm	50 x 25mm	
Fixing clips	Eaves, verge & tile clips	
Nail size for tiles*	75 x 3.35mm (A/A)	
Pallet quantities	Tiles per pallet 252 / tiles per pack 42 / packs per pallet 6	

*(A/A) Aluminium Alloy

† When roof slope includes inclined valleys, minimum pitch is 15°. If the roof slope includes roof windows check with the window manufacturer what the minimum pitch specifications are.



Slate Grey

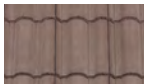

Tudor Brown

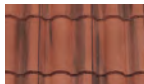

Farmhouse Red



REGENT

CONCRETE

PRODUCT CODES

TILES	Previous code	Code
Regent Tile Slate Grey	340130	10001723
Regent Tile Tudor Brown	340136	10001725
Regent Tile Farmhouse Red	340139	10001726
UNDERLAYS		
Divoroll Elite 200 2S	915700	10002797
Divoroll Universal 2S	915600	10002796
EAVES PRODUCTS		
Rapid EavesVent 2-in-1 Tray	998800	20001276
Rapid EavesVent Rafter Roll (6m)	998400	20001275
RedVent 25 Over-Fascia Vent (5m)	959300	20001230
Underlay Support Tray (1.5m)	907600	20001461
Eaves Comb Filler (1m)	996500	10002894
VERGE PRODUCTS		
DryVerge (Pack of 18 LH & 18 RH Terracotta)	939034	10003121
DryVerge (Pack of 18 LH & 18 RH) Slate Grey	939030	10003217
DryVerge (Pack of 18 LH & 18 RH) Brown	939036	10003122
DryVerge Gable End Pack Terracotta	988034	10002864
DryVerge Gable End Pack Slate Grey	988030	10002863
DryVerge Gable End Pack Brown	988036	10002865
Rapid DryVerge (pack of 18 LH & 18 RH) Slate Grey	939130	10002821
Rapid DryVerge (pack of 18 LH & 18 RH) Rust	939155	10002822
Rapid DryVerge Gable End Pack Slate Grey	988130	10002869
Rapid DryVerge Gable End Pack Rust	988155	10002870
HIP PRODUCTS		
Continuous Hip (5m)	902800	20001082
Third Round Hip/Ridge Junction	952100	20001212
Uni-Vent Rapid Ridge/Hip (10m)	931300	10002813
Uni-Vent Rapid Hip Support Tray (10 x 1.2m)	906900	20001084
Third Round Hip (without nail holes) Terracotta	812234	10002492
Third Round Hip (without nail holes) Slate Grey	812230	10002491

Fittings and components continued >

HIP PRODUCTS CONTINUED	Previous code	Code
Third Round Hip (with nail holes) Slate Grey	741130	10002217
Third Round Hip (with nail holes) Tudor Brown	741136	10002219
Third Round Hip (with nail holes) Terracotta	741134	10002218
Third Round Block End Hip Slate Grey	778430	10002375
Third Round Block End Hip Tudor Brown	778436	10002377
Third Round Block-End Hip Terracotta	778434	10002376
Hip End Cap Third Round Terracotta	971234	10002850
Hip End Cap Third Round Brown	971236	10002851
Mortar Bedded Fixing Kit	931400	10002814



VALLEY PRODUCTS	Previous code	Code
GRP 125 Valley (3m)	959500	20001231
Dry Valley (High Profile) (3m)	957400	20001224
ABUTMENT PRODUCTS		
Top Edge Abutment Ventilation (3m)	954200	10002835
Wakaflex Rapid Flashing (see pages 148-149)		
Bonding Strip (High Profile) (3m)	957800	20001226
RIDGE PRODUCTS		
DryVent Ridge (2.7m)	909600	10002757
Uni-Vent Rapid Ridge/Hip (10m)	931300	10002813
Continuous Ridge (5m)	930400	10002810
Half Round Ridge Slate Grey	810130	10002481
Half Round Ridge Terracotta	810134	10002482
Half Round Ridge Tudor Brown	810136	10002483
Half Round Block End Ridge Slate Grey	751930	10002249
Half Round Block End Ridge Terracotta	751934	10002250
Half Round Block End Ridge Tudor Brown	751936	10002251
Half Round Monoridge Slate Grey	720330	10002075
Half Round Monoridge Terracotta	720334	10002076
Half Round Monoridge Tudor Brown	720336	10002077
Monoridge Half Round End Cap LH Rust	976355	20001385
Monoridge Half Round End Cap LH Slate Grey	976330	20001384
Monoridge Half Round End Cap RH Rust	976455	20001387
Monoridge Half Round End Cap RH Slate Grey	976430	20001386
Mortar Bedded Fixing Kit	931400	10002814
Ridge End Cap Half Round Slate Grey	977230	20001251
Ridge End Cap Half Round Rust	977255	20001252
VENTILATION TILES		
Regent RedLine Vent Farmhouse Red	911539	20001099
Regent RedLine Vent Slate Grey	911530	20001096
Regent RedLine Vent Tudor Brown	911536	20001098
Regent 8.8k ThruVent Slate Grey	793030	10002423
Regent 8.8k ThruVent Tudor Brown	793036	10002425
Regent 8.8k ThruVent Farmhouse Red	793039	10002426
Flexible Pipe (100 to 100mm)	917200	20001149
FIXING		
Tile Clip	924600	20001162
Verge Clip LH	912100	20001392
Verge Clip RH	929800	20001401
Eaves Clip Inc Nail	928700	10003246
Tile Clip Nail (680)	933300	20001173
Tile Nail (420)	933700	20001176
Kro-Clip (50)	914200	10003245
Innofix Clip Red (250)	-	11000253

Renown

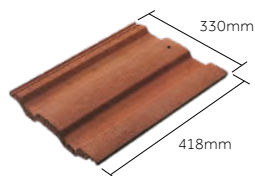

KEY FEATURES AND ADVANTAGES

- Four colours to provide a match with every regional roofing style
- Exceptional wind and driving rain performance
- Quicker installation saves time and money

PRODUCT DETAILS

Size (overall)	418 x 330mm
Minimum pitch and headlap	17.5° at 100mm headlap / 22.5° at 75mm headlap
Maximum pitch (subject to fixing specification)	90°
Maximum headlap	125mm
Minimum gauge/batten spacing	293mm
Maximum gauge/batten spacing	below 22.5° at 318mm / 22.5° and over 343mm
Hanging length (approx)	397mm
Cover (all figures are net and do not allow for wastage)	
Linear cover of 1 tile	300mm
Covering capacity	10.5 tiles/m ² at 318mm gauge / 9.7 tiles/m ² at 343mm gauge
Weight per pallet, including pallet (approx.) per 1000	43kg/m ² at 318mm gauge / 40kg/m ² at 343mm gauge 1.05 tonnes 4.14 tonnes
Battens required (at max. gauge)	2.92m/m ²
Batten size	
Rafter centres up to 450mm	38 x 25mm
Rafter centres up to 600mm	50 x 25mm
Fixing clips	Eaves, verge & tile clips
Nail size for tiles*	50 x 3.35mm (A/A)
Pallet quantities	Tiles per pallet 240 / tiles per pack 40 / packs per pallet 6

*(A/A) Aluminium Alloy

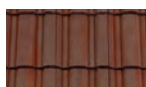

Breckland Brown

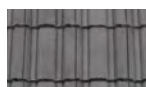

Slate Grey

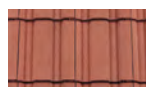

Terracotta

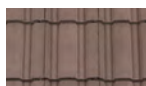

Tudor Brown

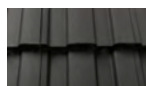

Charcoal Grey

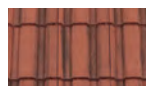

Farmhouse Red



CONCRETE

RENEW

PRODUCT CODES

TILES	Previous code	Code
Renown Tile Breckland Brown	150152	10003044
Renown Tile Slate Grey	150130	10003040
Renown Tile Terracotta	150134	10001706
Renown Tile Tudor Brown	150136	10003042
Renown Tile Farmhouse Red	150139	10003043
Renown Tile Charcoal Grey	-	11000186
UNDERLAYS		
Divoroll Elite 200 2S	915700	10002797
Divoroll Universal 2S	915600	10002796
EAVES PRODUCTS		
Rapid EavesVent 2-in-1 Tray	998800	20001276
Rapid EavesVent Rafter Roll (6m)	998400	20001275
RedVent 25 Over-Fascia Vent (6m)	959300	20001230
Underlay Support Tray (1.5m)	907600	20001461
VERGE PRODUCTS		
Renown LH Cloaked Verge Breckland Brown	727752	10002160
Renown LH Cloaked Verge Slate Grey	727730	10002156
Renown LH Cloaked Verge Terracotta	727734	10002157
Renown LH Cloaked Verge Tudor Brown	727736	10002158
Renown LH Cloaked Verge Farmhouse Red	727739	10002159
Renown RH Cloaked Verge Breckland Brown	727852	10002168
Renown RH Cloaked Verge Slate Grey	727830	10002164
Renown RH Cloaked Verge Terracotta	727834	10002165
Renown RH Cloaked Verge Tudor Brown	727836	10002166
Renown RH Cloaked Verge Farmhouse Red	727839	10002167
Renown Half Tile Breckland Brown	771052	10002327
Renown Half Tile Slate Grey	771030	10002323
Renown Half Tile Terracotta	771034	10002324
Renown Half Tile Tudor Brown	771036	10002325
Renown Half Tile Farmhouse Red	771039	10002326

Fittings and components continued >

FITTINGS AND COMPONENTS

VERGE PRODUCTS CONTINUED	Previous code	Code
DryVerge (Pack of 18 LH & 18 RH) Slate Grey	939030	10003217
DryVerge (Pack of 18 LH & 18 RH) Terracotta	939034	10003121
DryVerge (Pack of 18 LH & 18 RH) Brown	939036	10003122
DryVerge (Pack of 18 LH & 18 RH) Charcoal Grey	939077	10003123
DryVerge Gable End Pack Slate Grey	988030	10002863
DryVerge Gable End Pack Terracotta	988034	10002864
DryVerge Gable End Pack Brown	988036	10002865
DryVerge Gable End Pack Charcoal Grey	988077	10002866
Rapid DryVerge (Pack of 18 LH & 18 RH) Slate Grey	939130	10002821
Rapid DryVerge (Pack of 18 LH & 18 RH) Rust	939155	10002822
Rapid DryVerge (Pack of 18 LH & 18 RH) Charcoal Grey	939177	10002823
Rapid DryVerge Gable End Pack Slate Grey	988130	10002869
Rapid DryVerge Gable End Pack Rust	988155	10002870
Rapid DryVerge Gable End Pack Charcoal Grey	988177	10002871
HIP PRODUCTS		
Continuous Hip (5m)	902800	20001082
Third Round Hip/Ridge Junction	952100	20001212
Uni-Vent Rapid Ridge/Hip (10m)	931300	10002813
Uni-Vent Rapid Hip Support Tray (10 x 1.2m)	906900	20001084
Third Round Hip (without nail holes) Slate Grey	812230	10002491
Third Round Hip (without nail holes) Terracotta	812234	10002492
Third Round Hip (without nail holes) Tudor Brown	812236	10002493
Third Round Hip (without nail holes) Charcoal Grey	821277	10002556
Third Round Hip (with nail holes) Slate Grey	741130	10002217
Third Round Hip (with nail holes) Terracotta	741134	10002218
Third Round Hip (with nail holes) Tudor Brown	741136	10002219
Third Round Hip (with nail holes) Charcoal Grey	821177	10002550
Third Round Block End Hip Slate Grey	778430	10002375
Third Round Block End Hip Terracotta	778434	10002376
Third Round Block End Hip Tudor Brown	778436	10002377
Third Round Block End Hip Charcoal Grey	740477	10002200
Hip End Cap Third Round Terracotta	971234	10002850
Hip End Cap Third Round Brown	971236	10002851
Mortar Bedded Fixing Kit	931400	10002814
VALLEY PRODUCTS		
GRP 125 Valley (3m)	959500	20001231
Dry Valley (High Profile) (3m)	957400	20001224
ABUTMENT PRODUCTS		
Top Edge Abutment Ventilation (3m)	955400	10002837
Wakaflex Rapid Flashing (see pages 148-149)		
Bonding Strip (Low Profile) (3m)	957800	20001226

RIDGE PRODUCTS	Previous code	Code
DryVent Ridge (2.7m)	909700	10002758
Uni-Vent Rapid Ridge/Hip (10m)	931300	10002813
Continuous Ridge (5m)	930400	10002810
Half Round Ridge Slate Grey	810130	10002481
Half Round Ridge Terracotta	810134	10002482
Half Round Ridge Tudor Brown	810136	10002483
Half Round Ridge Charcoal Grey	820177	10002544
Half Round Block End Ridge Slate Grey	751930	10002249
Half Round Block End Ridge Terracotta	751934	10002250
Half Round Block End Ridge Tudor Brown	751936	10002251
Half Round Block End Ridge Charcoal Grey	740977	10002210
DryVent Monoridge (2.7m)	908100	10002751
Half Round Monoridge Slate Grey	720330	10002075
Half Round Monoridge Terracotta	720334	10002076
Half Round Monoridge Tudor Brown	720336	10002077
Half Round Monoridge Charcoal Grey	740377	10002194
Monoridge End Cap Half Round LH Rust	976355	20001385
Monoridge End Cap Half Round LH Slate Grey	976330	20001384
Monoridge End Cap Half Round RH Rust	976455	20001387
Monoridge End Cap Half Round RH Slate Grey	976430	20001386
Mortar Bedded Fixing Kit	931400	10002814
Ridge End Cap Half Round Slate Grey	977230	20001251
Ridge End Cap Half Round Rust	977255	20001252
VENTILATION TILES		
RedLine Vent Tile Farmhouse Red	911639	20001104
RedLine Vent Tile Breckland Brown	911652	20001105
RedLine Vent Tile Slate Grey	911630	20001101
RedLine Vent Tile Terracotta	911634	20001102
RedLine Vent Tile Tudor Brown	911636	20001103
8.8k ThruVent Breckland Brown	793252	10002442
8.8k ThruVent Slate Grey	793230	10002438
8.8k ThruVent Tudor Brown	793236	10002440
8.8k ThruVent Farmhouse Red	793239	10002441
Flexible Pipe (100 to 100mm)	917200	20001149
Rapid Roof Vent Grey	912730	10002781
Rapid Roof Vent Adaptor	979100	10002861
FIXING		
Tile Clip	918500	20001394
Verge Clip	929700	20001169
Eaves Clip	918600	20001155
Tile & Eaves Clip Nail (approx 812)	933800	20001177
Tile Nail (approx 680)	933300	20001173
Kro-Clip (50)	914200	10003245
Innofix Clip Orange (250)	-	11000230

Redland 49

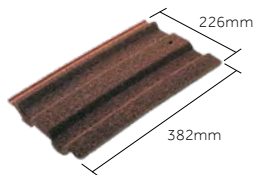

KEY FEATURES AND ADVANTAGES

- Unique camber adds both strength and aesthetic appeal
- Smaller format for lighter unit weight and easier handling
- A hallmark tile for London and the South-East

PRODUCT DETAILS

Size (overall)	382 x 226mm	
Minimum pitch and headlap	17.5° at 100mm headlap / 25° at 75mm headlap	
Through coloured	22.5° at 100mm headlap / 30° at 75mm headlap	
Granular		
Maximum pitch (subject to fixing specification and fire resistance requirements above 69°)	90°	
Maximum headlap	125mm	
Minimum gauge/batten spacing	257mm	
Maximum gauge/batten spacing	below 25° at 282mm / 25° and over 307mm	
Through coloured	below 30° at 282mm / 30° and over 307mm	
Granular		
Hanging length (approx)	360mm	
Cover (all figures are net and do not allow for wastage)		
Linear cover of 1 tile	200mm	
Covering capacity	17.7 tiles/m ² at 282mm gauge / 16.3 tiles/m ² at 307mm gauge	
Weight	51kg/m ² at 282mm gauge / 47kg/m ² at 307mm gauge	
per pallet, including pallet (approx.)	1.01 tonnes	
per 1000	2.86 tonnes	
Battens required (at max. gauge)	3.26m/m ²	
Batten size	38 x 25mm	
Rafter centres up to 450mm	50 x 25mm	
Rafter centres up to 600mm		
Fixing clips	Eaves, verge & tile clips	
Nail size for tiles*	50 x 3.35mm (A/A)	
Pallet quantities	Tiles per pallet 336 / tiles per pack 42 / packs per pallet 8	

*(A/A) Aluminium Alloy



REDLAND 49

CONCRETE

PRODUCT CODES

TILES	Previous code	Code
Redland 49 Brown	110102	10001691
Redland 49 Antique Red	110103	10001692
Redland 49 Slate Grey	110130	10001693
Redland 49 Terracotta	110134	10001695
Redland 49 Tudor Brown	110136	10001696
Redland 49 Farmhouse Red	110139	10001697
Redland 49 Breckland Brown	110152	10001698
Redland 49 Rustic Red	110178	10001700
UNDERLAYS		
Divoroll Elite 200 2S	915700	10002797
Divoroll Universal 2S	915600	10002796
EAVES PRODUCTS		
Rapid EavesVent 2-in-1 Tray	998800	20001276
Rapid EavesVent Rafter Roll (6m)	998400	20001275
RedVent 25 Over-Fascia Vent (6)	959300	20001230
Underlay Support Tray (1.5m)	907600	20001461
VERGE PRODUCTS		
DryVerge (Pack of 18 LH & 18 RH) Slate Grey	939030	10003217
DryVerge (Pack of 18 LH & 18 RH) Terracotta	939034	10003121
DryVerge (Pack of 18 LH & 18 RH) Brown	939036	10003122
DryVerge (Pack of 18 LH & 18 RH) Red	939078	10003247
DryVerge Gable End Pack Slate Grey	988030	10002863
DryVerge Gable End Pack Terracotta	988034	10002864
DryVerge Gable End Pack Brown	988036	10002865
DryVerge Gable End Pack Red	988078	10002867
Rapid DryVerge (Pack of 18 LH & 18 RH) Slate Grey	939130	10002821
Rapid DryVerge (Pack of 18 LH & 18 RH) Rust	939155	10002822
Rapid DryVerge Gable End Pack Slate Grey	988130	10002869
Rapid DryVerge Gable End Pack Rust	988155	10002870
HIP PRODUCTS		
Continuous Hip (5m)	950200	20001204
Third Round Hip/Ridge Junction	952100	20001212

Fittings and components continued >

HIP PRODUCTS CONTINUED	Previous code	Code
Uni-Vent Rapid Ridge/Hip (10m)	931300	10002813
Uni-Vent Rapid Hip Support Tray (10 x 1.2m)	906900	20001084
Third Round Hip (without nail holes) Brown	812202	10002486
Third Round Hip (without nail holes) Antique Red	812203	10002487
Third Round Hip (without nail holes) Slate Grey	812230	10002491
Third Round Hip (without nail holes) Terracotta	812234	10002492
Third Round Hip (without nail holes) Tudor Brown	812236	10002493
Third Round Hip (without nail holes) Rustic Red	812278	10002495
Third Round Hip (with nail holes) Brown	741102	10002212
Third Round Hip (with nail holes) Antique Red	741103	10002213
Third Round Hip (with nail holes) Slate Grey	741130	10002217
Third Round Hip (with nail holes) Terracotta	741134	10002218
Third Round Hip (with nail holes) Tudor Brown	741136	10002219
Third Round Hip (with nail holes) Rustic Red	741178	10002221
Third Round Block-End Hip Brown	778402	10002370
Third Round Block-End Hip Antique Red	778403	10002371
Third Round Block-End Hip Slate Grey	778430	10002375
Third Round Block-End Hip Terracotta	778434	10002376
Third Round Block-End Hip Tudor Brown	778436	10002377
Third Round Block-End Hip Rustic Red	778478	10002379
Hip End Cap Third Round Terracotta	971234	10002850
Hip End Cap Third Round Brown	971236	10002851
Mortar Bedded Fixing Kit	931400	10002814
VALLEY PRODUCTS		
GRP 125 Valley (3m)	959500	20001231
Dry Valley (High Profile) (3m)	957400	20001224
ABUTMENT PRODUCTS		
Wakaflex Rapid Flashing (see pages 148-149)		
Bonding Strip (High Profile) (3m)	957800	20001226



RIDGE PRODUCTS	Previous code	Code
Uni-Vent Rapid Ridge/Hip (10m)	931300	10002813
Continuous Ridge (5m)	930400	10002810
Half Round Ridge Brown	810102	10002476
Half Round Ridge Antique Red	810103	10002477
Half Round Ridge Slate Grey	810130	10002481
Half Round Ridge Tudor Brown	810136	10002483
Half Round Ridge Terracotta	810134	10002482
Half Round Ridge Rustic Red	810178	10002485
Half Round Ridge Block-End Brown	751902	10002244
Half Round Ridge Block-End Antique Red	751903	10002245
Half Round Ridge Block-End Slate Grey	751930	10002249
Half Round Ridge Block-End Tudor Brown	751936	10002251
Half Round Ridge Block-End Terracotta	751934	10002250
Half Round Ridge Block-End Rustic Red	751978	10002253
Half Round Monoridge Brown	720302	10002070
Half Round Monoridge Antique Red	720303	10002071
Half Round Monoridge Slate Grey	720330	10002075
Half Round Monoridge Terracotta	720334	10002076
Half Round Monoridge Tudor Brown	720336	10002077
Half Round Monoridge Rustic Red	720378	10002079
Monoridge End Cap Half Round LH Rust	976355	20001385
Monoridge End Cap Half Round LH Slate Grey	976330	20001384
Monoridge End Cap Half Round RH Rust	976455	20001387
Monoridge End Cap Half Round RH Slate Grey	976430	20001386
Mortar Bedded Fixing Kit	931400	10002814
Ridge End Cap Half Round Slate Grey	977230	20001251
Ridge End Cap Half Round Rust	977255	20001252
VENTILATION TILES		
4.5k ThruVent Tile Brown	733402	10002181
4.5k ThruVent Tile Antique Red	733403	10002182
4.5k ThruVent Tile Breckland Brown	733452	10002187
4.5k ThruVent Tile Slate Grey	733430	10002183
4.5k ThruVent Tile Tudor Brown	733436	10002185
4.5k ThruVent Tile Terracotta	733434	10002184
4.5k ThruVent Tile Farmhouse Red	733439	10002186
4.5k ThruVent Tile Rustic Red	733478	10002188
Flexible Pipe (75 to 100mm)	918800	20001156
FIXING		
Tile Clip	918500	20001394
Verge Clip	929700	20001169
Eaves Clip (100)	918400	20001153
Tile & Eaves Clip Nail (approx 812)	933800	20001177
Tile Clip Nail (approx 680)	933300	20001173
Kro-Clip (50)	914200	10003245
Innofix Clip Orange (250)	-	11000230

Fenland Pantile

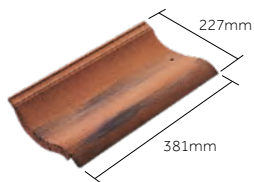

KEY FEATURES AND ADVANTAGES

- Gentle curve for soft yet distinctive single pantile effect
- Economical concrete alternative to clay
- Recessed front for a slim leading-edge appearance

PRODUCT DETAILS

Size (overall)	381 x 227mm
Minimum pitch and headlap	17.5° at 100mm headlap / 22.5° at 75mm headlap
Maximum pitch (subject to fixing specification and fire resistance requirements above 69°)	90°
Maximum headlap	125mm
Minimum gauge/batten spacing	256mm
Maximum gauge/batten spacing	below 22.5° at 281mm / 22.5° and over 306mm
Hanging length (approx)	362mm
Cover (all figures are net and do not allow for wastage)	
Linear cover of 1 tile	200mm
Covering capacity	17.8 tiles/m ² at 281mm gauge / 16.3 tiles/m ² at 306mm gauge
Weight per pallet, including pallet (approx.) per 1000	45kg/m ² at 281mm gauge / 42kg/m ² at 306mm gauge 0.91 tonnes 2.55 tonnes
Battens required (at max. gauge)	3.27m/m ²
Batten size	
Rafter centres up to 450mm	38 x 25mm
Rafter centres up to 600mm	50 x 25mm
Fixing clips	Eaves, verge & tile clips
Nail size for tiles*	45 x 3mm (A/A)
Pallet quantities	Tiles per pallet 336 / tiles per pack 42 / packs per pallet 8

*(A/A) Aluminium Alloy

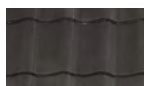

Black (coated)



Terracotta



Breckland Brown

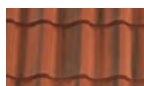

Farmhouse Red



FENLAND PANTILE

CONCRETE

PRODUCT CODES

TILES	Previous code	Code
Fenland Pantile Breckland Brown	512152	10001804
Fenland Pantile Terracotta	512134	10001801
Fenland Pantile Farmhouse Red	512139	10001803
Fenland Pantile Black	512163	10001805
UNDERLAYS		
Divoroll Elite 200 2S	915700	10002797
Divoroll Universal 2S	915600	10002796
EAVES PRODUCTS		
Rapid EavesVent 2-in-1 Tray	998800	20001276
Rapid Eaves Vent Rafter Roll (6m)	998400	20001275
RedVent 25 Over-Fascia Vent (6m)	959300	20001230
Underlay Support Tray (1.5m)	907600	20001461
Eaves Comb Filler (1m)	996500	10002894
VERGE PRODUCTS		
DryVerge (Pack of 18 LH & 18 RH) Charcoal Grey	20001184	10003123
DryVerge (Pack of 18 LH & 18 RH) Terracotta	20001182	10003121
DryVerge (Pack of 18 LH & 18 RH) Brown	20001183	10003122
DryVerge (Pack of 18 LH & 18 RH) Red	939078	10003247
DryVerge Gable End Pack Charcoal Grey	988077	10002866
DryVerge Gable End Pack Terracotta	988034	10002864
DryVerge Gable End Pack Brown	988036	10002865
DryVerge Gable End Pack Red	988078	10002867
Rapid DryVerge (Pack of 18 LH & 18 RH) Rust	939155	10002822
Rapid DryVerge (Pack of 18 LH & 18 RH) Charcoal Grey	939177	10002823
Rapid DryVerge Gable End Pack Rust	988155	10002870
Rapid DryVerge Gable End Pack Charcoal Grey	988177	10002871
HIP PRODUCTS		
Continuous Hip (5m)	950200	20001204
Third Round Hip/Ridge Junction	952100	20001212
Uni-Vent Rapid Ridge/Hip (10m)	931300	10002813
Uni-Vent Rapid Hip Support Tray (10 x 1.2m)	906900	20001084
Third Round Hip (without nail holes) Terracotta	812234	10002492
Third Round Hip (without nail holes) Tudor Brown	812236	10002493
Third Round Hip (without nail holes) Black	812263	10002494



HIP PRODUCTS CONTINUED	Previous code	Code
Third Round Hip (with nail holes) Terracotta	741134	10002218
Third Round Hip (with nail holes) Tudor Brown	741136	10002219
Third Round Hip (with nail holes) Black	741163	10002220
Third Round Block End Hip Terracotta	778434	10002376
Third Round Block End Hip Tudor Brown	10002377	10002377
Third Round Block End Hip Black	778463	10002378
Hip End Cap Third Round Terracotta	971234	10002850
Hip End Cap Third Round Brown	971236	10002851
Hip End Cap Third Round Black	971263	10002852
Mortar Bedded Fixing Kit	931400	10002814
VALLEY PRODUCTS		
GRP 125 Valley (3m)	959500	20001231
Dry Valley (High Profile) (3m)	957400	20001224
ABUTMENT PRODUCTS		
Wakaflex Rapid Flashing (see pages 148-149)		
Bonding Strip (High Profile) (3m)	957800	20001226
RIDGE PRODUCTS		
Uni-Vent Rapid Ridge/Hip (10m)	931300	10002813
Continuous Ridge (5m)	930400	10002810
Half Round Ridge Terracotta	810134	10002482
Half Round Ridge Tudor Brown	810136	10002483
Half Round Ridge Black	810163	10002484
Half Round Block End Ridge Terracotta	751934	10002250
Half Round Block End Ridge Tudor Brown	751936	10002251
Half Round Block End Ridge Black	751963	10002252
Half Round Monoridge Terracotta	720334	10002076
Half Round Monoridge Tudor Brown	720336	10002077
Half Round Monoridge Black	720363	10002078
Monoridge End Cap Half Round LH Rust	976355	20001385
Monoridge End Cap Half Round RH Rust	976455	20001387
Mortar Bedded Fixing Kit	931400	10002814
Ridge End Cap Half Round Rust	977255	20001252
VENTILATION TILES		
4.5k ThruVent Tile Breckland Brown	732852	10002179
4.5k ThruVent Terracotta	732834	10002176
4.5k ThruVent Farmhouse Red	732839	10002178
4.5k ThruVent Black	732863	10002180
Flexible Pipe (75 to 100mm)	918800	20001156
FIXING		
Tile Clip	917700	20001150
Verge Clip LH	914800	20001393
Verge Clip RH	914900	20001148
Eaves Clip	917800	20001151
Tile Clip Nail (approx 680)	933300	20001173
Eaves Clip Nail (approx 812)	933800	20001177
Tile Nail (approx 1060)	933400	20001174
Kro-Clip (50)	914200	10003245
Innofix Clip Red (250)	-	11000253

Roofing System Accessories

From underlays to ridge systems, we have a comprehensive range of roof products. All elements of our roofs are carefully designed, tested and manufactured to give value, visual appeal and long-lasting weathertight performance.



PV Solar

PV InDaX Adapt 92-93

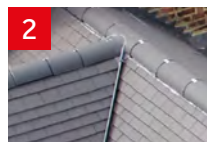

Roof Fittings

Concrete Ridge and Hip Fittings 95
Concrete Plain Tile Fittings 96
Rosemary Clay Plain Tile Fittings 97

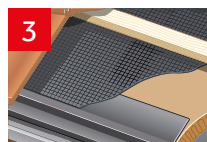

Underlay

Divoroll Elite 200 2S 98-99
Divoroll Universal 2S 100-101

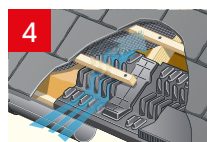

Eaves Systems

RedVent 25 Over-Fascia Vent 102-103
Rapid Eaves Vent System 104-105



Verge Systems

Cloaked Verge 106-109
DryVerge and Rapid DryVerge Systems 110-113

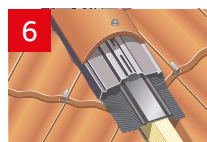

Hip Systems

Continuous Hip System 114-115
Cambrian Mitred Hip System 116-117

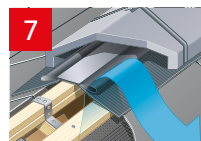

Ridge Systems

DryVent Ridge System 118-119
Continuous Ridge System 120-121
Uni-Vent Rapid Ridge/Hip 122-123
DryVent Monoridge System 124-125

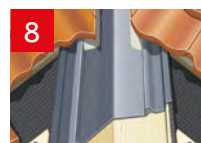

Valley Systems

125 and Cambrian GRP Valley 126-127
Dry Valley 128-129

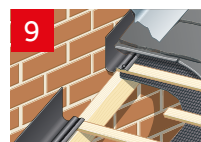

Abutment Systems

Bonding Strip 130-131
Side Abutment GRP Secret Gutter 132-133
Top Edge Abutment Ventilation System 134-135

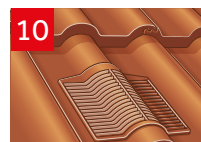

Ventilation Products

RedLine Vent Tile 136-139
ThruVent Tile 140-143
Rapid Roof Vent Tile 144-147



Accessories

Wakaflex Rapid Flashing 148-149
Mortar Bedded Fixing Kit 150
Kro-Clip 151
Innofix Clip 152-153
Hip End Cap 154
Ridge End Cap 155
Monoridge End Cap 156

PV InDaX Adapt

A roof can do so much more than offer protection from the elements.

The expanse of a roof provides one of the best locations to introduce solar technologies and take advantage of the benefits that integrated solar can bring.

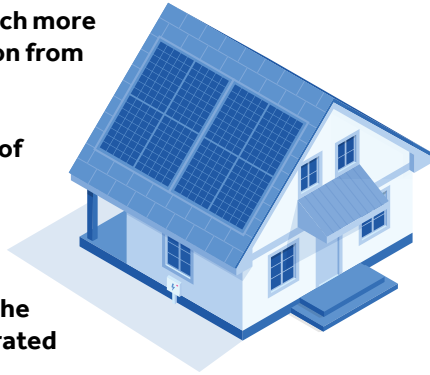

KEY FEATURES AND ADVANTAGES

- **Single source:**
Complete BMI Redland-sourced pitched roofing system
- **Compatibility:**
Designed for and validated compatibility with all Redland tiles
- **Design flexibility:**
Achieve any desired configuration type in portrait format, without compromising performance
- **Specify with confidence:**
PV InDaX Adapt is tested and validated to the Redland standard providing confidence and certainty of full system performance



Based on proven crystalline technology, the PV InDaX Adapt in-roof photovoltaic system offers high output performance in an attractive and weathertight roof covering. The panel sits in line with the surrounding tiles (rather than on-top like many panels), creating an improved aesthetic and weathertight system.

Not only can the PV system provide flexibility in format and module specification, but the modules can also be installed to the edge of the roof, allowing the greatest flexibility in design to meet the required aesthetics for your project.





FULL SYSTEM, FULL SUPPORT

We provide a complete and fully integrated solar PV, pitched roofing system design service, to help you build zero carbon ready homes that fulfil your carbon reduction targets.

We understand that not every development is the same and there is no one-size-fits-all approach:

From initial site assessment and design through to completion, our technical services team will work with your architects, designers and energy assessors to develop the right pitched in-roof solar PV system for your development, according to your targets and development needs.



 **ECOMASTER**

EcoMaster is BMI Redland's free-of-charge PV design and specification service.

It correctly specifies all the Redland PV InDaX Adapt components needed for your Solar PV project. Solar PV systems specified, installed, commissioned and maintained in accordance with Redland instructions are covered by a 25-year Power Output Guarantee for the panels.

An initial feasibility study can be carried out for your project by completing the form on: bmgroupp.com/uk/ecomaster.

Further information about the BMI PV InDaX Adapt system is available at bmgroupp.com/uk/indax

Roof Fittings

With a huge choice of concrete, clay and slate fittings - for verges, hips, valleys, ridges, ornamental tiles, and more - we have the fittings to complement and complete every roof.

All elements of our roofs are carefully designed, tested and manufactured to give value, visual appeal and long-lasting weathertight performance.



Concrete Ridge and Hip Fittings

We offer a broad range of fittings to complete your roof. Available in a range of colours and finishes to suit your roof. Quick and easy to fit and designed to provide a neat and attractive finish to your roof's ridge line.

2

FEATURES

- Easy to install
- Can be dry fixed or mortar bedded and mechanically fixed, providing flexibility in installation
- Designed to match perfectly with Redland concrete tiles

COMPATIBILITY

Available in all tile colours found within the Redland tile range.

PERFORMANCE

Mechanical fixing is required to comply with BS 5534 and BS 8612

PRODUCTS



Universal Angle Ridge



Half Round Ridge



Universal Angle Monoridge



Half Round Monoridge



Universal Angle Hip



Third Round Hip

Concrete Plain Tile Fittings

With a huge choice of concrete fittings for verges, hips, valleys, ridges, and more, we have the fittings to complement and complete every roof, and for the most striking plain tile roofs, our Plain Tile Fittings provide a perfect finish for every detail.

FEATURES

- Easy to install
- Complete the detail on any plain tile roof
- Exceed the strength requirements of BS 5534

COMPATIBILITY

Available in all concrete Plain Tile and Heathland tile colours within the Redland range.

PERFORMANCE

Mechanical fixing is required to comply with BS 5534 and BS 8612

PRODUCTS



Half Round Ridge



Third Round Hip



Pascal Roll



Concrete Baby Ridge



Concrete Valley Tile



Concrete Bonnet Tile



Plain Tile External Angle



Half Round Monoridge



Ornamental Club Tile

Rosemary Clay Plain Tile Fittings

For the most striking plain tile roofs, our Rosemary Clay Plain Tile Fittings provide a perfect finish for every detail.

FEATURES

- Complete the detail on any Rosemary Clay plain tile roof
- Made from high quality Etruria Marl clay
- Exceed the strength requirements of BS 5534

COMPATIBILITY

Available in all Redland Rosemary Clay Classic and Rosemary Clay Craftsman plain tile colours found within the range.

PERFORMANCE

Mechanical fixing is required to comply with BS 5534 and BS 8612

PRODUCTS

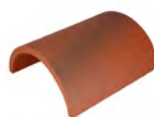

Rosemary Clay Half Round Ridge Tile



Rosemary Clay Third Round Hip Tile



Rosemary Clay Valley Tile



Rosemary Clay Bonnet Tile



Rosemary Clay Arris Hip Tile



Rosemary Clay External Angle Tile



Rosemary Clay Baby Ridge



Rosemary Clay Ornamental Club Tile

Divoroll Elite 200 2S & Underlay Support Tray

A vapour permeable underlay with integral glue strips, independently tested by the BRE for use in all of the UK wind uplift zones in accordance with BS 5534.

FEATURES

- Strong and durable membrane with a reinforced grid.
- Provides a windtight system for warm and hybrid roofs for energy efficiency
- Unique glue strips means no requirement for over lap batten
- Can be used without eaves ventilation when used in conjunction a well sealed ceiling and ridge or other high-level ventilation
- Underlay Support Tray required at eaves
- BBA Certificate 20/5734
- Cost saving

PERFORMANCE

- Outstanding protection against falling objects
- Best in class watertightness after abrasion
- Suitable for use in all wind zones throughout the country in accordance with BS 5534
- Complies with BS 5250 in meeting the vapour resistance requirement of a low resistance underlay

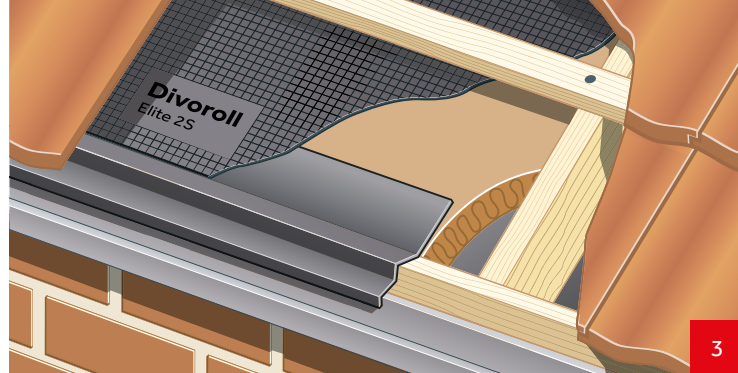
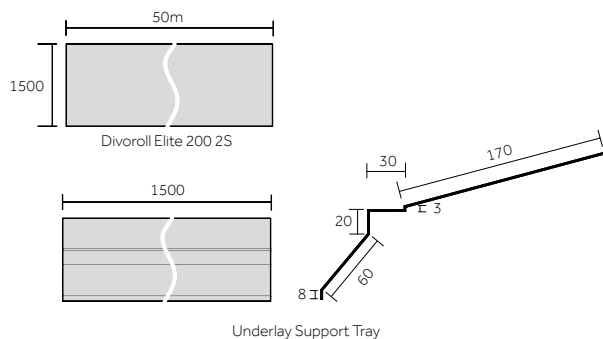

DIVOROLL ELITE 200 2S
& UNDERLAY SUPPORT TRAY

3

DIVOROLL ELITE 200 2S ON EAVES (MINI STONEWOLD)

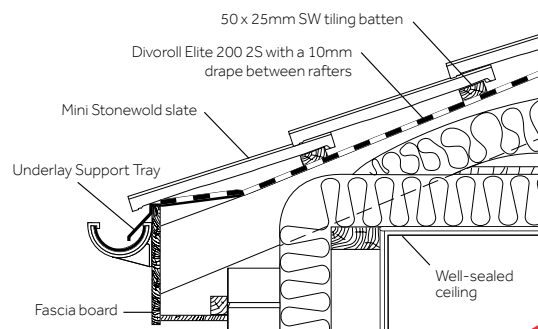

COMPONENTS Sold individually

Divoroll Elite 200 2S	
Roll Size	1.5 x 50m
Roll Area	75m ²
Weight per m ²	195g/m ²
Roll Weight	15kg
Material	4-layer, spun bond polypropylene
Pack Quantity	1 roll
Underlay Support Tray	
Tray Length	1.5m
Material	Recycled PVC
Pack Quantity	25

PRODUCT CODES

	Previous code	Code
Divoroll Elite 200 2S	9157	10002797
Underlay Support Tray	9076	20001461



This product is suitable for use as part of a BMI Redland specified roof system covered by a **SpecMaster** 15 year Guarantee

Divoroll Universal 2S & Underlay Support Tray

A vapour permeable underlay with integral glue strips, independently tested by the BRE for use in all of the UK wind uplift zones in accordance with BS 5534.

FEATURES

- Strong and durable membrane with a reinforced grid.
- Provides a windtight system for warm and hybrid roofs for energy efficiency
- Unique glue strips means no requirement for over lap batten
- Can be used without eaves ventilation when used in conjunction with a well sealed ceiling and ridge or other high level ventilation
- Underlay Support Tray required at eaves
- Suitable for all wind zones throughout the country in accordance with BS 5534
- BBA Certificate 20/5734
- Cost saving

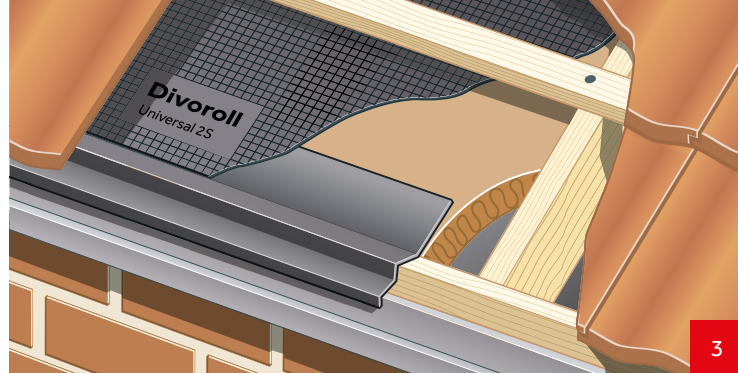
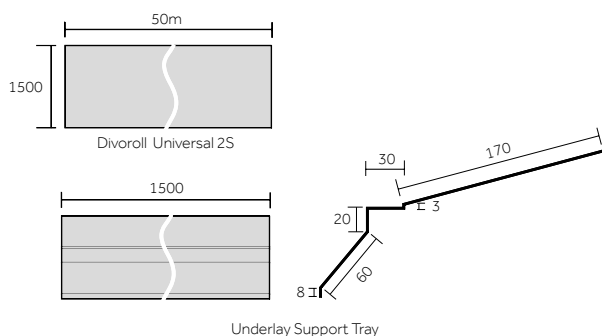

3

DIVOROLL UNIVERSAL 2S
& UNDERLAY SUPPORT TRAY

DIVOROLL UNIVERSAL 2S ON EAVES (MINI STONEWOLD)

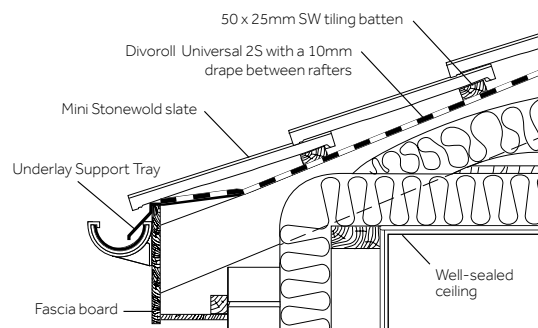

COMPONENTS Sold individually

Divoroll Universal 2S

Roll Size	1.5 x 50m
Roll Area	75m ²
Weight	150g/m ²
Material	4-layer, spun bond polypropylene

Underlay Support Tray

Tray Length	1.5m
Material	Recycled PVC
Pack Quantity	25

PRODUCT CODES

	Previous code	Code
Divoroll Universal 2S	915600	10002796
Underlay Support Tray	907600	20001461

RedVent 25 Over-Fascia Vent

Provides unobtrusive continuous ventilation at the eaves for use where the insulation is installed either between or above the rafters.

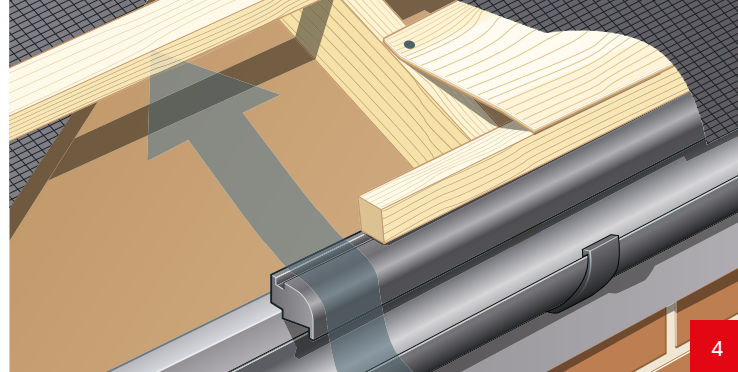

FEATURES

- Ventilates to comply with BS 5250, therefore reducing the risk of harmful condensation in the roof
- Used for any combination of rafter spacing
- Can be installed with or without a soffit board
- Eaves closure is achieved for Regent, Grovebury, Fenland Pantile, by using Eaves Comb

COMPATIBILITY

- Suitable for use with most pitched roofing materials
- Where Eaves Clips, Eaves Comb or Underlay Support Trays are required, a 25 x 25mm softwood clip batten should be secured through the RedVent 25 Over-Fascia Vent into the fascia board with 100 x 4mm galvanized nails
- Suitable for uPVC fascias with additional timber fillet behind the fascia board

PERFORMANCE

- Minimum pitch will depend on the minimum pitch of the roof covering
- Height of fascia and maximum pitch varies with tile used. Please contact Technical Services on 0330 123 4585
- The effective ventilation area per metre run of eaves is 25,000mm²

REDVENT 25 OVER-FASCIA VENT (GROVEBURY)

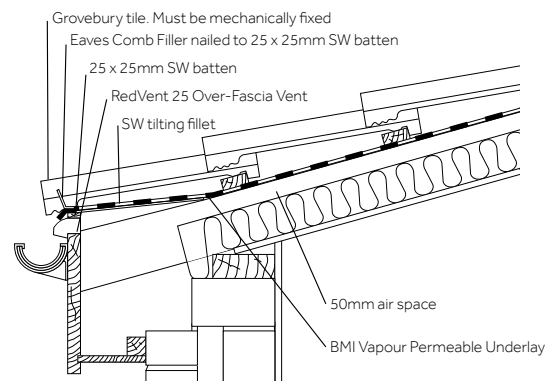

COMPONENTS

Each RedVent 25 Over-Fascia Vent pack contains:

12 Fascia Grilles sufficient for 6 metres of eaves (Polypropylene – Black)



RedVent 25 Over-Fascia Vent

PRODUCT CODES

	Previous code	Code
RedVent 25 Over-Fascia Vent	9593	20001230



This product is suitable for use as part of a BMI Redland specified roof system covered by a **SpecMaster** 15 year Guarantee

Rapid Eaves Vent System

Designed for use in cold pitched roofs as a means of introducing low level roof space ventilation.

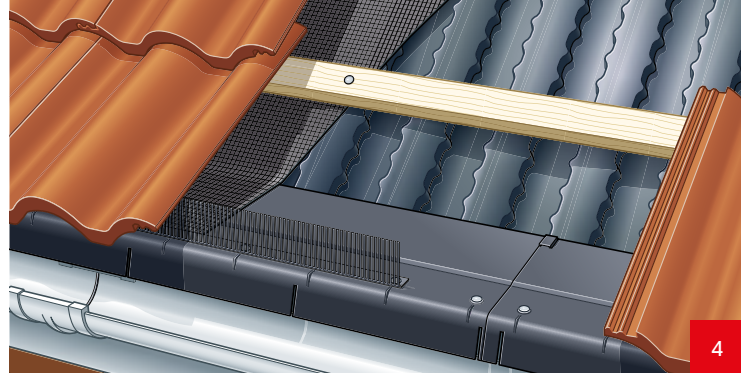

4

FEATURES

- 3-part system, sold separately:

Rapid 2-in-1 Eaves Tray

Provides continuous ventilation over the fascia while supporting the underlay at the eaves to ensure a positive fall of the underlay into the eaves gutter

Rafter Roll

A semi-rigid, roll-out rafter ventilation tray that maintains an uninterrupted air ventilation gap between the underlay and ceiling-level insulation in the loft space

Eaves Comb

Used to prevent birds, large insects, rodents etc. from entering the roof space. Eaves Combs are required for the following BMI Redland tiles: Grovebury, Regent, Fenland Pantile.

- Maintenance-free
- Quick and easy to install
- Ventilates to comply with BS 5250, therefore reducing the risk of harmful condensation in the roof

COMPATIBILITY

- Can be used with either non-vapour permeable or vapour permeable underlay
- Works with any BMI Redland slate/tile or similar
- Suitable for use with most pitched roofing materials
- Compatible with timber fascias up to 25mm thick
- Suitable for uPVC fascias with an additional timber fillet behind the fascia board
- Suitable for rafter centres up to 600mm

PERFORMANCE

- Rafter pitch range is 15° - 70°
- The effective ventilation area per metre run of eaves is 10,000mm²
- Height of fascia and maximum pitch varies with tile used. Please contact Technical Services on 0330 123 4585

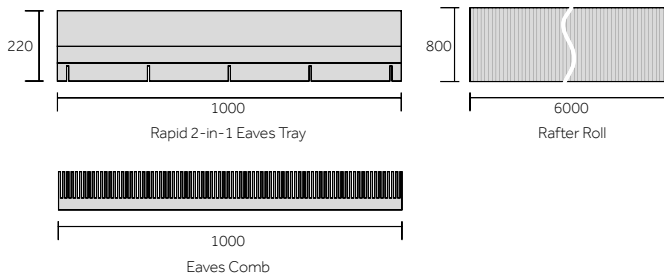

RAPID EAVES VENT SYSTEM (MINI STONEWOLD)

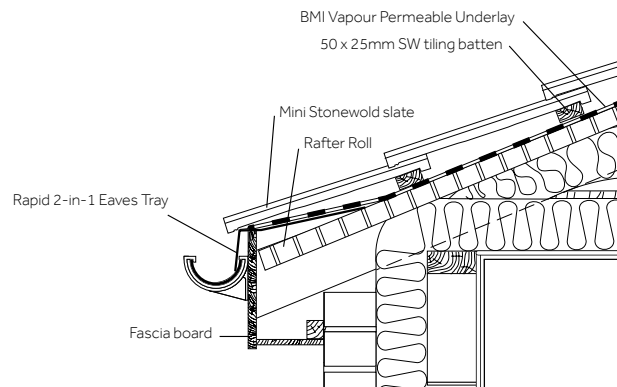

COMPONENTS 3-part system sold separately

Rafter Roll

Roll Size	6m x 0.8m
Material	PVC

Rapid 2-in-1 Eaves Tray

Tray Length	1m
Material	Polypropylene

Eaves Comb

Comb Length	1m
Material	Polypropylene

PRODUCT CODES

	Previous code	Code
Rafter Roll	998400	20001275
Rapid 2-in-1 Eaves Tray	998800	20001276
Eaves Comb	996500	10002894



This product is suitable for use as part of a BMI Redland specified roof system covered by a **SpecMaster 15 year Guarantee**

Cloaked Verge

The Cloaked Verge continues the tiling over the gable end using a one-piece concrete tile. The system has very high resistance to storm damage and, with no mortar required, it removes concerns about mortar failure.

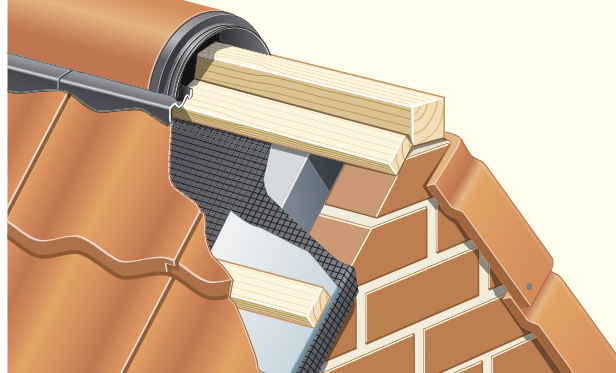

FEATURES

- Easy to lay as it interlocks to the next tile
- The quickest and easiest method of installing profiled verge tiles
- Provides a neat finish to the verge
- Complies with BS 5534: requirements for mechanical fixing
- Complies with BS 8612

COMPATIBILITY

- Available for all our profiled tiles except Fenland Pantile, Redland 49 and Regent

PERFORMANCE

- There is no maximum pitch on lean-to roofs or where lead roll details are used
- On duo-pitch roofs above 45° the top cloaked verge tiles must be cut to a mitre (subject to fixing specification and fire resistance requirements above 69°)
- Minimum pitch will depend upon the minimum pitch for the tile profile and surface finish
- Minimum headlap will depend upon tile profile, surface finish and rafter pitch
- Maximum pitch of cloaked verge depends upon maximum pitch of ridge/monoridge system

CONCRETE CLOAKED VERGE

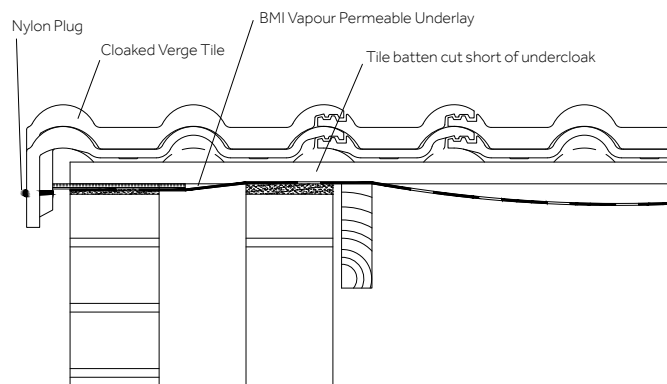

COMPONENTS

Cloaked Verge Tile

Length	418mm
Material	Concrete
Plug Material	Nylon

ACCESSORIES

- Half-Tile (concrete tiles)
- Block-End Ridge Tile



This product is suitable for use as part of a BMI Redland specified roof system covered by a **SpecMaster** 15 year Guarantee

CLOAKED VERGE

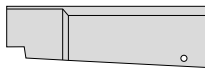
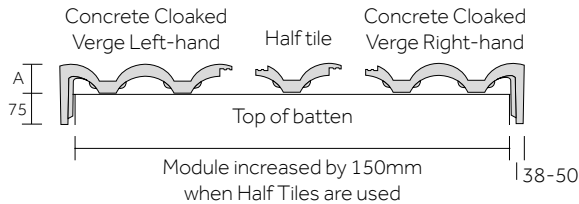
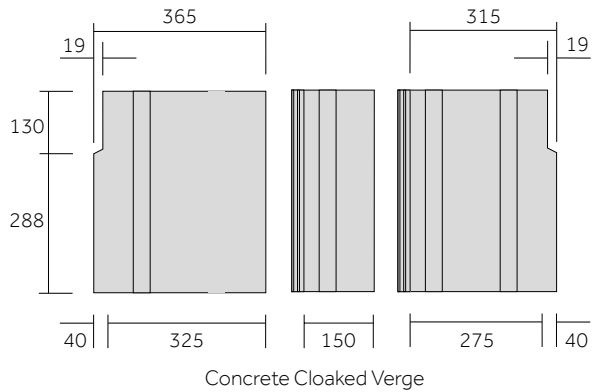

Concrete Cloaked Verge Left-hand



Concrete Cloaked Verge Right-hand

PRODUCT MEASUREMENTS (MM)

Profile	A
Grovebury	47
50 Double Roman	37
Renown	30

CLOAKED VERGE PRODUCT CODES	LH		RH	
	Previous code	Code	Previous code	Code
Grovebury Breckland Brown	727352	10002125	727452	10002134
Grovebury Slate Grey	727330	10002121	727430	10002130
Grovebury Terracotta	727334	10002122	727434	10002131
Grovebury Tudor Brown	727336	10002123	727436	10002132
Grovebury Farmhouse Red	727339	10002124	727439	10002133
Grovebury Charcoal Grey	727377	10002126	727477	10002135
50 Double Roman Breckland Brown	727552	10002143	727652	10002151
50 Double Roman Slate Grey	727530	10002139	727630	10002147
50 Double Roman Terracotta	727534	10002140	727634	10002148
50 Double Roman Tudor Brown	727536	10002141	727636	10002149
50 Double Roman Farmhouse Red	727539	10002142	727639	10002150
50 Double Roman Rustic Red	727578	10002144	727678	10002152
Renown Breckland Brown	727752	10002160	727852	10002168
Renown Slate Grey	727730	10002156	727830	10002164
Renown Terracotta	727734	10002157	727834	10002165
Renown Tudor Brown	727736	10002158	727836	10002166
Renown Farmhouse Red	727739	10002159	727839	10002167

DryVerge, Rapid DryVerge* & Cambrian Ambi-DryVerge II systems

The first dry fix products launched following the publication of BS 8612, each comfortably achieving the code's requirements for durability, wind loading and rain resistance.



FEATURES

- Secure four point fixing system provides high resistance to wind loads for both verge tile and dry verge system
- Quick to install and can be laid at variable gauges to suit the minimum and maximum headlaps of the tiles
- Cambrian Ambi-DryVerge II can be used to fit either the left or right-hand verge by simply snapping off the relevant end tab
- Drip point and water channels in design avoid gable end staining
- The first dry fix verge designed specifically to meet the new BS 8612

COLOUR CODES

DryVerge

Metric/15x9 & Slate 10 DryVerge & Gable End packs	Slate Grey Terracotta Brown Charcoal Grey Red (Metric/15x9 only)
---	--

DuoPlain DryVerge & Gable End pack

Terracotta Brown Charcoal Grey Red

Rapid DryVerge

Metric/15x9 & Slate 10 DryVerge & Gable End packs	Slate Grey Rust Charcoal Grey
---	-------------------------------------

Ambi-DryVerge II

Cambrian & Eaves/Ridge Pack	Slate Grey
-----------------------------	------------

COMPONENTS

Each DryVerge and Rapid DryVerge system contains:

- 18 Left-hand verge units (DryVerge: HIPS/ Rapid DryVerge: ABS)
- 18 Right-hand verge units (DryVerge: HIPS/ Rapid DryVerge: ABS)
- 36 Stainless steel screws

Gable End Packs will be required for each installation which include:

- 2 Eaves Closure Units (DryVerge: HIPS/ Rapid DryVerge: ABS)
- 4 Stainless steel screws
- 1 Ridge Comb (PVC)

Each Cambrian Ambi-Dry Verge II system contains:

- 10 Ambi-DryVerge units (PVC)
- 10 Stainless steel verge clips

Eaves/Ridge Packs will be required for each installation which include:

- 1 Eaves Closure Unit (PVC)
- 2 Stainless Steel Eaves Clip
- 1 Ridge Comb (PVC)

In addition, Block-End Ridge Tiles or Ridge End Caps will be required at all ridge ends

DRYVERGE SYSTEM WITH OVERHANG

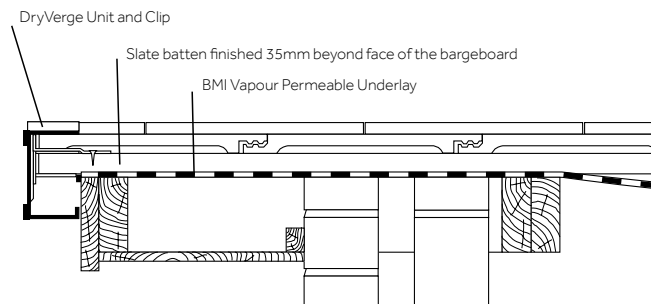

COMPATIBILITY

MAXIMUM PITCHES

Subject to fixing specification and fire resistance requirements above 69°

Tile / Slate	Duo-pitch Roofs	Mono-pitch Roofs
Cambrian Slate	60°	67.5°
Saxon 10 & Richmond 10 (inc MockBond)	50°	75°
Mini Stonewold (inc MockBond)	57.5°	72.5°
Grovebury	65°	75°
Regent	70°	70°
50 Double Roman	57.5°	72.5°
Renown	55°	75°
Fenland Pantile	55°	40°
Redland 49	35° †	65°
DuoPlain	60°	47.5°

† For pitches above 35° units require trimming at ridge apex



This product is suitable for use as part of a BMI Redland specified roof system covered by a **SpecMaster** 15 year Guarantee

DRYVERGE AND RAPID DRYVERGE SYSTEMS

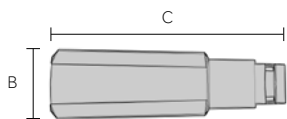

Cambrian Ambi-DryVerge II (front)



Cambrian Ambi-DryVerge II (top)



Cambrian Ambi-DryVerge II Clip

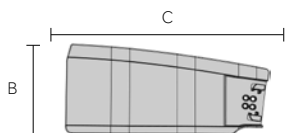

DuoPlain DryVerge (front)



DuoPlain DryVerge (top)



DuoPlain DryVerge (internal)

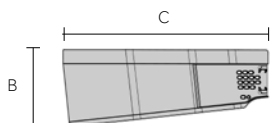

Metric/15x9 DryVerge (front)



Metric/15x9 DryVerge (top)



Metric/15x9 DryVerge (internal)

PRODUCT MEASUREMENTS (MM)

Profile	A	B	C
Cambrian Ambi-DryVerge II	60	85	305
DuoPlain DryVerge	53	115	240
Slate 10 DryVerge	52	127	413
Slate 10 Rapid DryVerge	52	127	413
Metric/15x9 DryVerge	52	154	413
Metric/15x9 Rapid DryVerge	52	154	413

PRODUCT CODES	Previous code	Code
Cambrian Ambi-DryVerge II	948800	10002828
Cambrian Ambi-Dry Eaves/Ridge Pack	949100	10002829
Slate 10 DryVerge Slate Grey	939230	10003144
Slate 10 DryVerge Terracotta	939234	10003145
Slate 10 DryVerge Brown	939236	10003146
Slate 10 DryVerge Charcoal Grey	939277	20001189
Slate 10 DryVerge Gable End Pack Slate Grey	988230	10002872
Slate 10 DryVerge Gable End Pack Terracotta	988234	10002873
Slate 10 DryVerge Gable End Pack Brown	988236	10002874
Slate 10 DryVerge Gable End Pack Charcoal Grey	988277	10002875
Slate 10 Rapid DryVerge Slate Grey	939330	10002824
Slate 10 Rapid DryVerge Rust	939355	10002825
Slate 10 Rapid DryVerge Charcoal Grey	939377	10002826
Slate 10 Rapid DryVerge Gable End Pack Slate Grey	988330	10002876
Slate 10 Rapid DryVerge Gable End Pack Rust	988355	10002877
Slate 10 Rapid DryVerge Gable End Pack Charcoal Grey	988377	10002878
Metric/15x9 DryVerge Slate Grey	939030	10003217
Metric/15x9 DryVerge Terracotta	939034	10003121
Metric/15x9 DryVerge Brown	939036	10003122
Metric/15x9 DryVerge Charcoal Grey	939077	10003123
Metric/15x9 DryVerge Red	939078	10003247
Metric/15x9 DryVerge Gable End Pack Slate Grey	988030	10002863
Metric/15x9 DryVerge Gable End Pack Terracotta	988034	10002864
Metric/15x9 DryVerge Gable End Pack Brown	988036	10002865
Metric/15x9 DryVerge Gable End Pack Charcoal Grey	988077	10002866
Metric/15x9 DryVerge Gable End Pack Red	939078	10002867
Metric/15x9 Rapid DryVerge Slate Grey	939130	10002821
Metric/15x9 Rapid DryVerge Rust	939155	10002822
Metric/15x9 Rapid DryVerge Charcoal Grey	939177	10002823
Metric/15x9 Rapid DryVerge Gable End Pack Slate Grey	988130	10002869
Metric/15x9 Rapid DryVerge Gable End Pack Rust	988155	10002870
Metric/15x9 Rapid DryVerge Gable End Pack Charcoal Grey	988177	10002871
DuoPlain DryVerge Terracotta	991634	10002880
DuoPlain DryVerge Brown	991636	10002881
DuoPlain DryVerge Charcoal Grey	991677	10002882
DuoPlain DryVerge Red	991678	10002883
DuoPlain DryVerge Gable End Pack Terracotta	927334	10002805
DuoPlain DryVerge Gable End Pack Brown	927336	10002806
DuoPlain DryVerge Gable End Pack Charcoal Grey	927377	10002807
DuoPlain DryVerge Gable End Pack Red	927378	10002808

Continuous Hip System

An easy and quick-to-fit, maintenance-free hip system with very high resistance to storm damage.

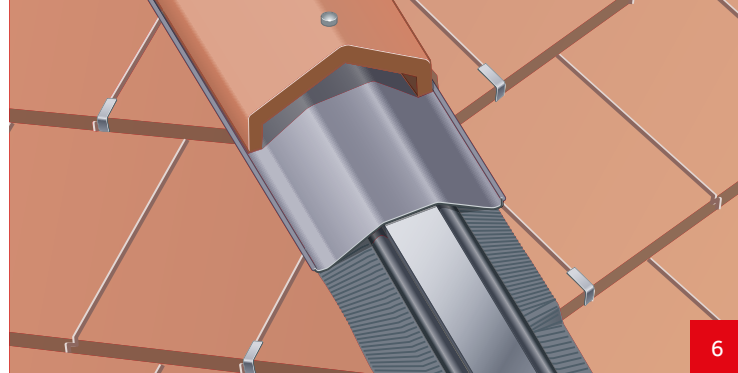

FEATURES

- Hips are up to a third quicker to complete than when mortar bedded
- Hip Tiles are secured to the appropriate size hip batten using Stainless Steel woodscrews, which give exceptional resistance to wind uplift
- Provides a neat and attractive finish to the hip line
- Easy to install and can be used even when bad weather is expected
- Ventilates the batten cavity to comply with BS 5250, therefore reducing the risk of harmful condensation in the roof (when used with Divoroll Elite 200 2S vapour permeable underlay)
- Tried and tested and complies with BS 5534 requirements for mechanical fixing
- Complies with BS 8612

COMPATIBILITY

- Suitable for use with the Continuous Ridge and Uni-Vent Rapid Ridge/ Hip Systems
- Suitable for use with Third Round and Universal Angle Hip Tiles
- Suitable for use with the BMI Redland range of tiles and slates

PERFORMANCE

- Minimum and maximum pitch will depend upon the minimum and maximum pitch of the roof tiles
- This system is designed for use where pitches to either side of the hip are equal. Where the roof pitches are uneven please contact Technical Services on 0330 123 4585

CONTINUOUS HIP SYSTEM WITH UNIVERSAL ANGLE HIP TILE (CAMBRIAN)

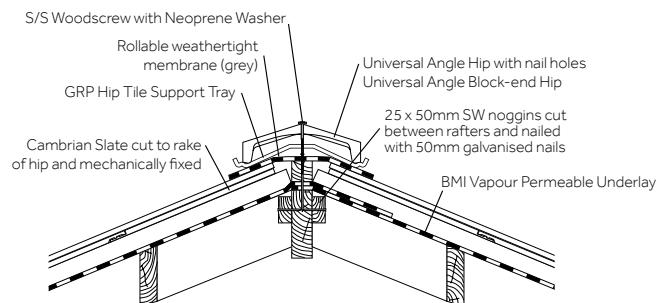

COMPONENTS

Each Continuous Hip pack contains sufficient components to secure 5 metres of concrete Hip Tiles:

- Rollable Weathertight Membrane (grey) – 295mm x 5m
- GRP Hip Tile Support Tray (grey)
- Hip Tile Supports (Polypropylene – black)
- Hip Batten Straps (Stainless Steel)
- Spacer Blocks (PVC – black)
- Head Clips (Stainless Steel)
- Tail Clips (Aluminium)
- 100mm Woodscrews (Stainless Steel)
- Rafter Nails (Stainless Steel)
- Hip Batten Nails (Stainless Steel)
- In addition, concrete Hip Tiles with nail holes will be required in a colour to suit, with matching Block-End Hip Tiles at the eaves
- A Hip/Ridge Junction will also be required where appropriate

PRODUCT CODES

	Previous code	Code
Metric tiles	902800	20001082
Fenland Pantile / Redland 49	950200	20001204
Natural Slate / Cambrian Slate	950300	20001205
DuoPlain	956200	20001220
Slate 10 / Plain Tile	952400	20001214

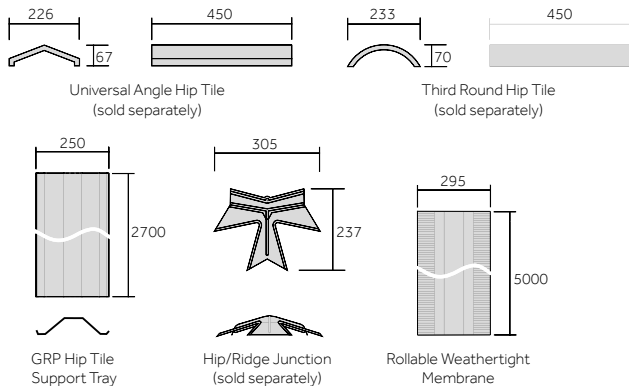

This product is suitable for use as part of a BMI Redland specified roof system covered by a **SpecMaster 15 year Guarantee**

Cambrian Mitred Hip System

Specifically designed for use with Cambrian Slates to achieve a neat mitred hip detail, whilst ensuring very high resistance to storm damage over a wide range of rafter pitches and plan angles.

FEATURES

- Provides a neat and attractive finish to the hip line
- Easy to install and can be used even when bad weather is expected
- Tried and tested and complies with BS 5534 requirements for mechanical fixing

COMPATIBILITY

- Suitable for use with all Cambrian slate products

PERFORMANCE

- At 90° plan angle, the minimum pitch is 15° and the maximum pitch is 80°. For other plan angles, refer to the table adjacent

COMPONENTS

The Cambrian Mitred Hip System contains sufficient components in each pack for ten courses of slates.

Each pack contains:

- Hip Weathering Units (Polypropylene – grey) x 10
- Tail Clips and Screws (Stainless Steel) x 10

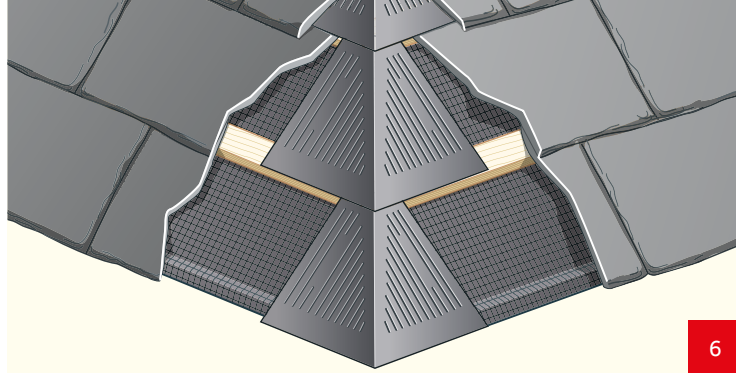

CAMBRIAN MITRED HIP SYSTEM

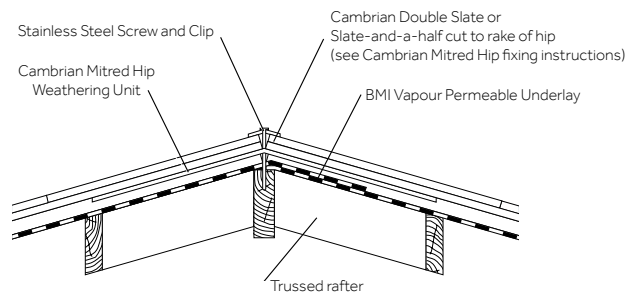

PLAN ANGLE AGAINST ROOF PITCH

Roof pitch (degrees)	Roof plan angle (degrees)									
	90	95	100	105	110	115	120	125	130	135
15	•	–	–	–	–	–	–	–	–	–
17.5	•	•	–	–	–	–	–	–	–	–
20	•	•	•	–	•	•	–	–	–	–
22.5	•	•	•	•	•	•	–	–	–	–
25	•	•	•	•	•	•	•	–	–	–
27.5	•	•	•	•	•	•	•	•	•	–
30	•	•	•	•	•	•	•	•	•	•
32.5	•	•	•	•	•	•	•	•	•	•
35	•	•	•	•	•	•	•	•	•	•
37.5	•	•	•	•	•	•	•	•	•	•
40	•	•	•	•	•	•	•	•	•	•
42.5	•	•	•	•	•	•	•	•	•	•
45	•	•	•	•	•	•	•	•	•	•
47.5	•	•	•	•	•	•	•	•	•	•
50	•	•	•	•	•	•	•	•	•	•
52.5	•	•	•	•	•	•	•	•	•	•
55	•	•	•	•	•	•	•	•	•	•
57.5	•	•	•	•	•	•	•	•	•	•
60-80	•	•	•	•	•	•	•	•	•	•
82.5-90	–	•	•	•	•	•	•	•	•	•

For higher plan angles please see website and Technical Data Sheet

PRODUCT CODE	Previous code	Code
Cambrian Mitred Hip System	950400	20001206

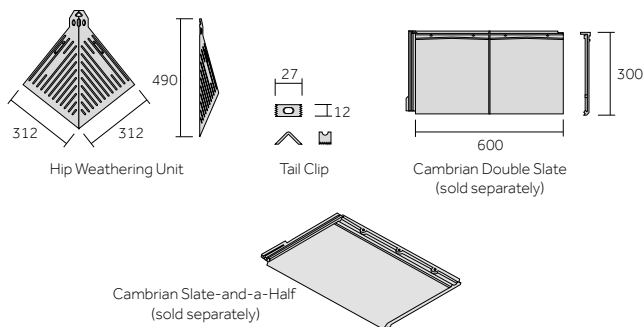

 This product is suitable for use as part of a BMI Redland specified roof system covered by a **SpecMaster 15 year Guarantee**

DryVent Ridge System

Provides a continuous, weathertight ventilation path from the roof void to the outside. The system can also be easily converted when no high-level ventilation is required at the ridge. Both solutions provide a durable method of securing ridge tiles.

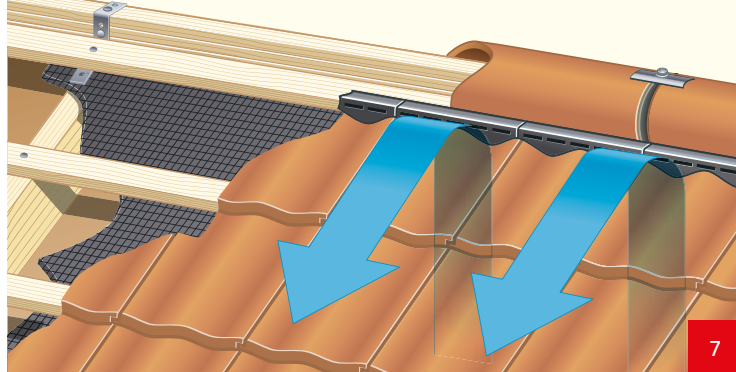

FEATURES

- Provides a neat and attractive finish to the ridge line
- Easy to install and can be used even when bad weather is expected
- Ventilates and complies with BS 5250, therefore reducing the risk of harmful condensation in the roof
- Tried and tested and complies with BS 5534 requirements for mechanical fixing
- Complies with BS 8612

COMPATIBILITY

- Suitable for use with concrete Half Round and Universal Angle Ridge Tiles and Rosemary Clay Half Round Ridge Tiles (300mm)

PERFORMANCE

- Must not be used in a pitch below 15°
- Gives an effective ventilation area of 10,000mm² per metre run of ridge

DRYVENT RIDGE SYSTEM

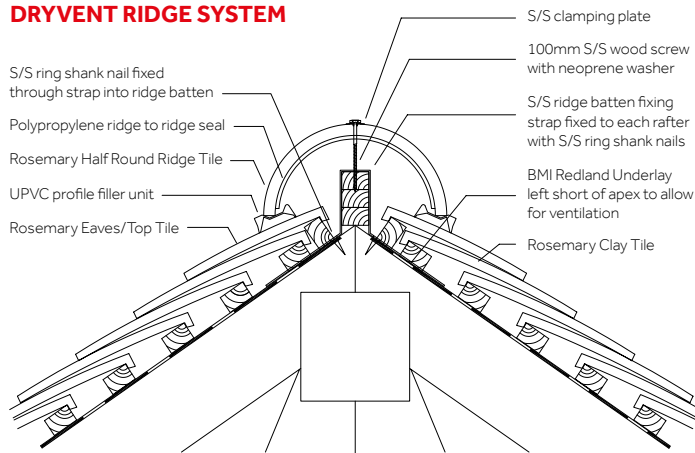

COMPONENTS

Each pack contains sufficient components to secure a 2.7 metre ridge line (1.8 metres for Rosemary tiles):

- Profile Units (uPVC: Grey): tile specific.

- 6 Ridge-to-Ridge Seals (either Universal Angle or Half Round) (Polypropylene black) with Stainless Steel woodscrews and clamp plates.
- 6 Stainless Steel ridge batten straps with 12 Stainless Steel ring shank nails.
- In addition, Block-End Ridge Tiles or Ridge End Caps will be required for all ridge situations.

PRODUCT CODES

PRODUCT CODES	Previous code	Code
Rosemary	902200	10002746
Flat Tiles (Half Round)	905800	10002747
Flat Tiles (Universal Angle)	905900	10002748
Grovebury	909400	10002755
50 Double Roman	909500	10002756
Regent	909600	10002757
Renown	909700	10002758



Universal Angle Ridge Tile (sold separately)

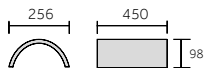

Half Round Ridge Tile (sold separately)

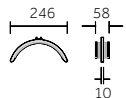

Ridge-to-Ridge Seal (Half Round shown to be used with concrete Half Round Ridge Tile)

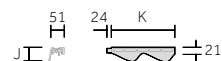

Profile Unit (Grovebury shown)

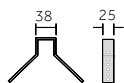

Ridge Batten Strap

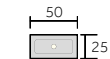

Clamping Plate

PRODUCT MEASUREMENTS (MM)

Profile Unit	J	K
Plain Tile appearance/Slate	21	450
Regent	59	298
Grovebury	59	298
50 Double Roman	47	298
Renown	40	298



This product is suitable for use as part of a BMI Redland specified roof system covered by a **SpecMaster** 15 year Guarantee

Continuous Ridge System

Provides both high-level ventilation and mechanically fixed ridge tiles. The system is a genuine alternative to a mortar-bedded ridge with the added advantage of being quicker and requiring less skill to install.

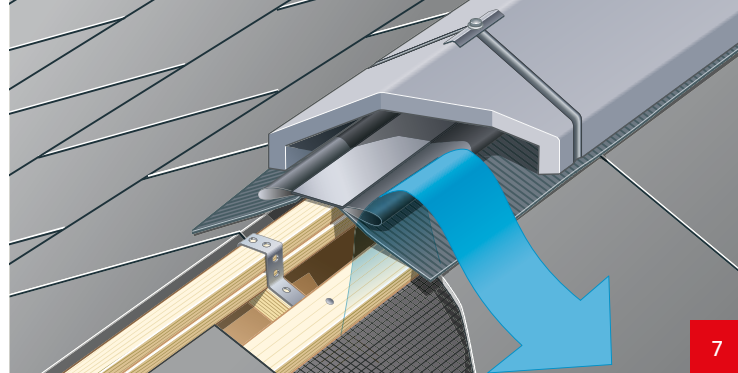

FEATURES

- Uses Ridge-to-Ridge Seals that match the profile of the BMI Redland ridge tiles perfectly to give a guaranteed weathertight seal
- Traditional appearance
- Quicker and easier to fit than a mortar-bedded ridge
- Easy to install and can be laid even when bad weather is expected
- Continuous Ridge System Ventilates and complies with BS 5250, therefore reducing the risk of harmful condensation in the roof void
- Tried and tested and complies with BS 5534 requirements for mechanical fixing
- Complies with BS 8612

COMPATIBILITY

- Compatible with natural slate, concrete slates, profile tiles and plain tiles
- For Rosemary clay tiles please contact Technical Services on 0330 123 4585
- Not compatible with Clay Half Round Ridge

PERFORMANCE

- Ventilates to give effective ventilation area of 5,000mm² per metre run of ridge

CONTINUOUS RIDGE SYSTEM (MINI STONEWOLD)

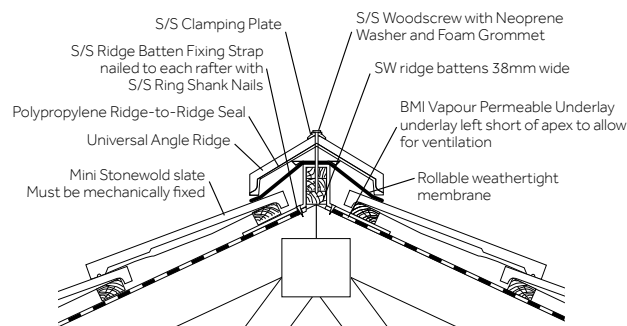

COMPONENTS

Each pack contains sufficient components to secure a 5 metre ridge line:

- 5 metres of Rollable Weathertight Membrane
- 11 Ridge-to-Ridge Seals (either Universal Angle or Half Round) (Polypropylene – black) with Stainless Steel woodscrews and clamp plates
- 9 Stainless Steel ridge batten straps with 18 Stainless Steel ring shank nails
- 2 Stainless Steel end ridge fixings

ACCESSORIES

- In addition, Block-End Ridge Tiles or Ridge End Caps will be required for all ridge situations

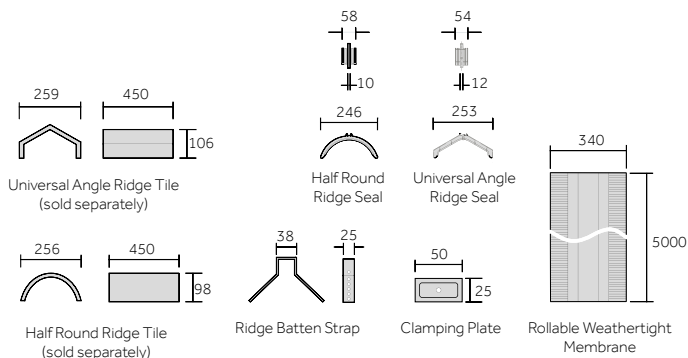

PRODUCT CODES

PRODUCT CODES	Previous code	Code
Flat Tiles/ Natural Slate/Cambrian (Half Round)	930200	10002809
Profile tiles (Half Round)	930400	10002810
Flat Tiles/ Natural Slate/Cambrian (Universal Angle)	930800	10002811



This product is suitable for use as part of a BMI Redland specified roof system covered by a **SpecMaster 15 year Guarantee**

Uni-Vent Rapid Ridge/Hip

Uni-Vent Rapid Ridge/Hip is a simple and quick to install system providing a secure, weatherproof and mortar-free universal solution for the mechanical fixing of ridge and hip tiles.

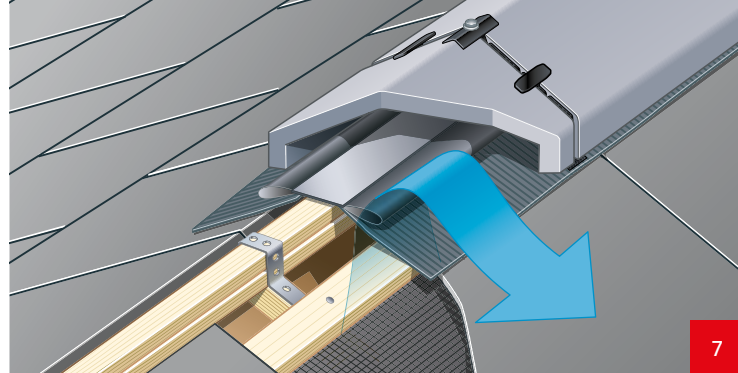

FEATURES

- Uses a flexible Ridge-to-Ridge Seal to enable use with both Half Round and Universal Angle concrete ridge tiles and similar ridge profiles
- Traditional appearance
- Quicker and easier to fit than a mortar-bedded ridge
- Easy to install and can be laid even when bad weather is expected
- Uni-Vent Rapid Ridge/Hip Ventilates and complies with BS 5250, therefore reducing the risk of harmful condensation in the roof void
- Complies with BS 5534 requirements for mechanical fixing
- Complies with BS 8612

COMPATIBILITY

- Compatible with natural slate, concrete slates, profile tiles and plain tiles
- For Rosemary clay tiles please contact Technical Services on 0330 123 4585
- Not compatible with Clay Half Round Ridge

PERFORMANCE

- Ventilates to give effective ventilation area of 5,000mm² per metre run of ridge

UNI-VENT RAPID RIDGE/HIP (MINI STONEWOLD)

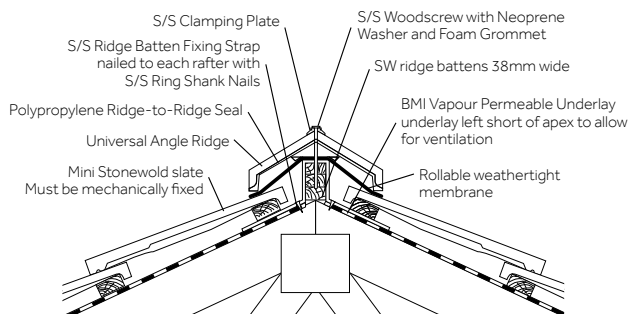

COMPONENTS

Each pack contains sufficient components to secure a 10 metre ridge line:

- 10 metres of Rollable Weathertight Membrane
- 22 Universal Flexi-Seals with Stainless Steel woodscrews and Clamping Plates
- 17 Stainless Steel Batten Straps with 34 Stainless Steel ring shank nails

ACCESSORIES

- In addition, Block-End Ridge Tiles or Ridge End Caps will be required for all ridge situations

For use on hips, the following accessories are also available (sold separately):

- Hip Support Tray (1.2m)
- Kro-Clips

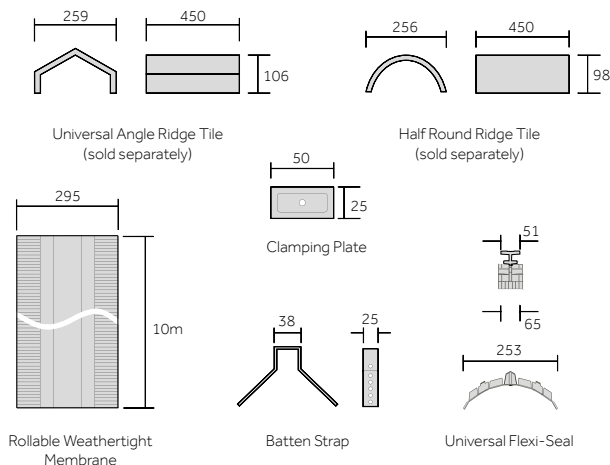

PRODUCT CODES

	Previous code	Code
Uni-Vent Rapid Ridge/Hip Pack (10m)	931300	10002813
Hip Support Tray (10 x 1.2m)	906900	20001084
Kro-Clips	914200	10003245

DryVent Monoridge System

Provides a continuous weathertight ventilation path from the roof void to the outside.
The mechanically-fixed system complies with the requirements of the Building Regulations.

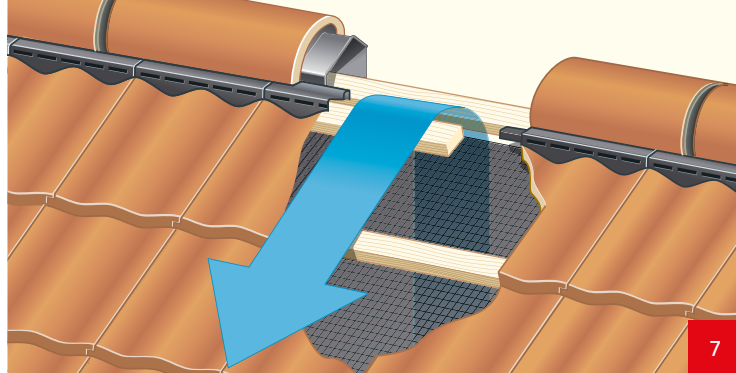

FEATURES

- Provides a neat and attractive finish
- Profile filler units bespoke to each tile type
- Easy to install and can be laid even when bad weather is expected
- Ventilates to comply with BS 5250, therefore reducing the risk of harmful condensation in the roof
- Tried and tested and complies with BS 5534 requirements for mechanical fixing
- Complies with BS 8612

COMPATIBILITY

- Available for all tiles and slates in the BMI Redland range except Fenland Pantile and Redland 49.
- Suitable for use with concrete Half Round and Universal Angle Monoridge Tiles

PERFORMANCE

- Minimum pitch will depend upon the minimum pitch of the roof tiles but must not be less than 15°
- Maximum pitch for DuoPlain, Grovebury, Renown and 50 Double Roman is 47.5°; maximum pitch for Slate 10 range and Mini Stonewold is 52.5°. For all other interlocking tiles, maximum pitch is 45°
- Maximum pitch for Plain Tiles is 55°
- The effective ventilation area per metre run of ridge is 5,000mm²

DRYVENT MONORIDGE SYSTEM (CAMBRIAN)

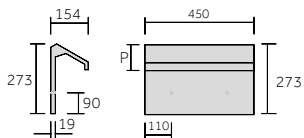
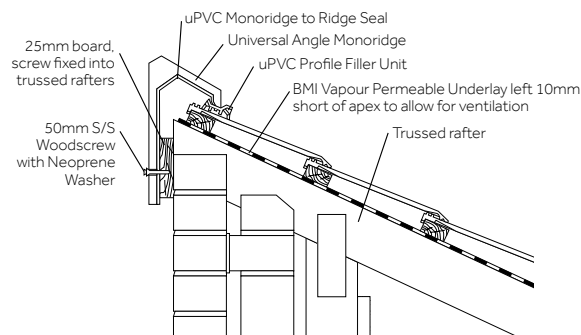

Monoridge Tile (Universal Angle shown) (sold separately)

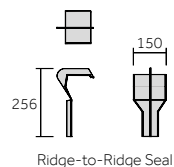

Ridge-to-Ridge Seal

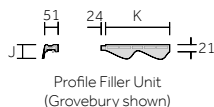

Profile Filler Unit (Grovebury shown)

PRODUCT MEASUREMENTS (MM)

Monoridge Tile	P
Half Round	98
Universal Angle	106
Profile Filler Unit	J K
Plain Tile appearance/Slate	21 450
Regent	59 298
Grovebury	59 298
50 Double Roman	47 298
Renown	40 298

COMPONENTS

Each pack contains sufficient components to secure 6 concrete Monoridge Tiles:

- Profile Filler Units (uPVC – grey) (tile specific)
- Monoridge, Ridge-to-Ridge Seal (polypropylene – black)
- Fixing Screws (Stainless Steel) and Washers (neoprene)

ACCESSORIES

- In addition, concrete Monoridge Tiles will be required in a colour to suit, with left or right-hand Monoridge End Caps
- A timber board, 25mm thick, must be fixed vertically to allow monoridge tile fixing

PRODUCT CODES

	Previous code	Code
Plain Tiles/Flat Tiles/ Cambrian/ Natural Slate	908400	10002753
Regent	907900	10002749
Grovebury	908000	10002750
50 Double Roman	908200	10002752
Renown	908100	10002751



This product is suitable for use as part of a BMI Redland specified roof system covered by a **SpecMaster 15 year Guarantee**

125 and Cambrian GRP Valleys

Designed as a cost-effective alternative to lead, the 125 and Cambrian GRP Valleys are easy to fix, durable and lightweight. They are ideal for most types of roof design which have a valley junction between two roof slopes.

FEATURES

- Easily cut and available in 3 metre lengths
- Tried and tested and complies with BS 5534 requirements for valleys
- Manufactured from long-lasting UV-resistant Glass Reinforced Polyester (GRP)

COMPATIBILITY

- 125 GRP Valley is suitable for all of the BMI Redland range of tiles and slates (except Cambrian Slates for which the Cambrian GRP Valley is used)

PERFORMANCE

- Minimum pitch 17.5° at 90° plan angle
- Maximum pitch 45° at 90° plan angle
- For pitch range at plan angles other than 90° please contact Technical Services on 0330 123 4585
- Width of valley gutter 125mm
- Where roof plan area discharging into the valley is greater than 25m², minimum rafter pitch is 30°
- Valley can accommodate a 5° pitch variance between slopes

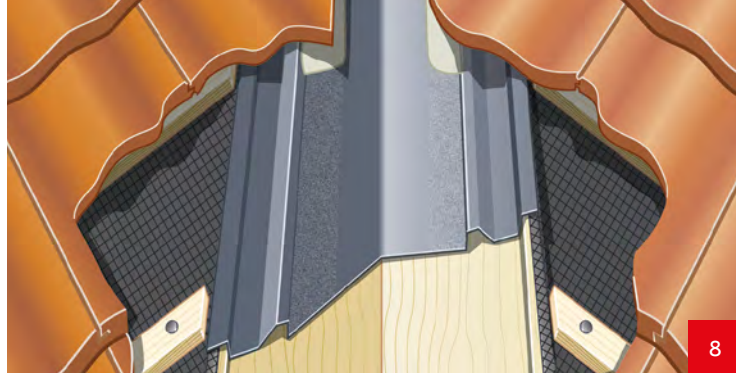

125 GRP VALLEY (FENLAND PANTILE)

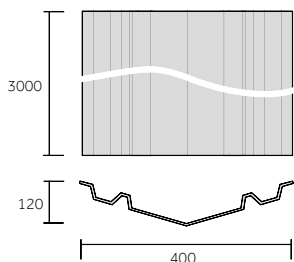
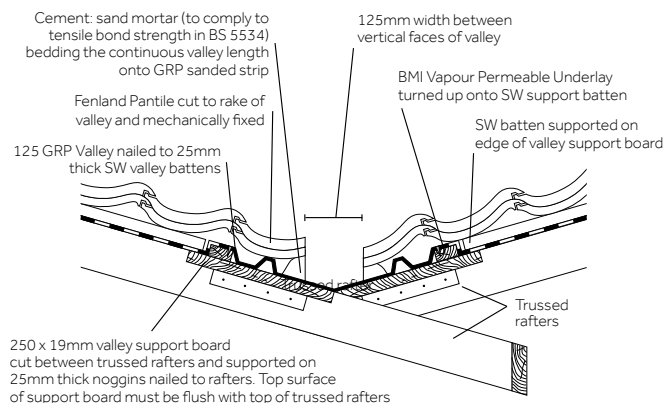

125 GRP Valley

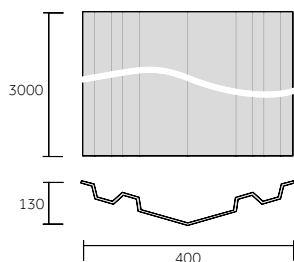

Cambrian GRP Valley

COMPONENTS

125 and Cambrian GRP Valleys

Valley Size	3m x 0.4m
Material	Glass Reinforced Polyester (GRP)

PRODUCT CODES

	Previous code	Code
Cambrian GRP Valley	955300	20001218
125 GRP Valley	959500	20001231



This product is suitable for use as part of a BMI Redland specified roof system covered by a **SpecMaster** 15 year Guarantee

Dry Valley

A mortar-free, dry fix system that is fast to install in all weather conditions providing a neat, close cut and mitred finish.

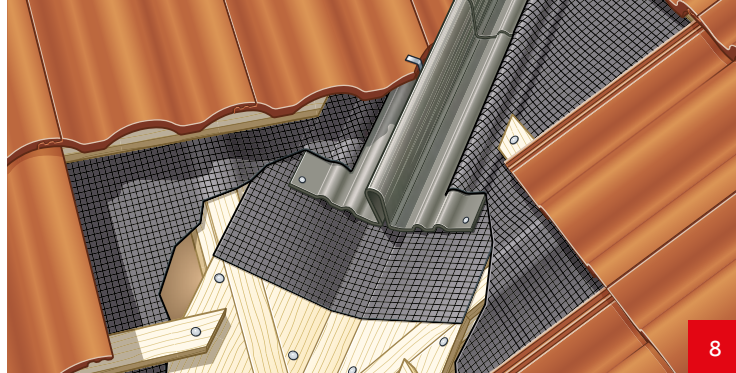

FEATURES

- Two products:
 - Dry Valley High Profile – with a central upstand of 105mm
 - Dry Valley Low Profile – with a central upstand of 80mm
- Available in standard lead grey colour
- Lightweight and flexible
- Safe and easy to cut
- Manufactured from long-lasting UV-resistant Glass Reinforced Polyester (GRP)

COMPATIBILITY

- Designed to fit directly onto either existing or new valley support boards
- Dry Valley High Profile is compatible with Plain Tile, Heathland, Rosemary Clay plain tiles and all BMI Redland profiled tiles

- Dry Valley Low Profile is compatible with Cambrian, natural slates, fibre-cement slates, all BMI Redland interlocking flat tiles and DuoPlain

PERFORMANCE

- Pitch range is 17.5 - 60° at any plan angle with a maximum difference between the two adjacent roof slopes of 20°
- Roof area on plan draining into valley is maximum 100m²
- No sealing or jointing material is required if the following overlaps and rafter pitches are used:
 - Below 22.5°: 350mm
 - 22.5° - 29.5°: 300mm
 - 30° - 39.5°: 200mm
 - 40° and above: 150mm

DRY VALLEY HIGH PROFILE (FENLAND PANTILE)

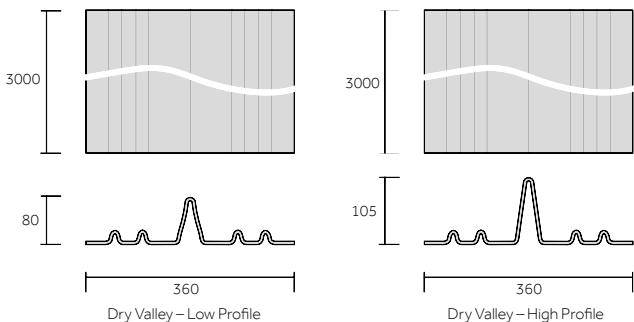
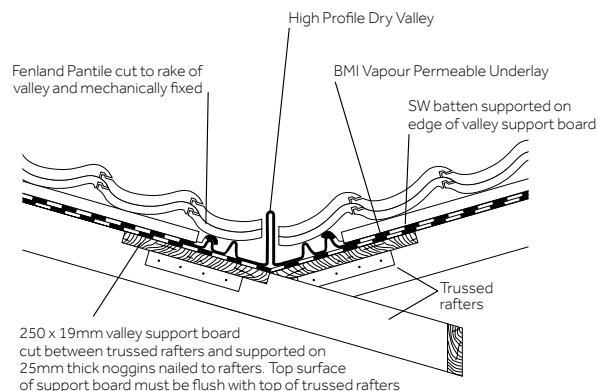

COMPONENTS

Dry Valley

Valley Size	3m x 0.36m
Material	Glass Reinforced Polyester (GRP)

PRODUCT CODES

	Previous code	Code
Dry Valley – Low Profile	957500	20001225
Dry Valley – High Profile	957400	20001224



This product is suitable for use as part of a BMI Redland specified roof system covered by a **SpecMaster 15 year Guarantee**

Bonding Strip

A mortar-free, dry fix system designed to weatherproof the junction between two adjacent roof coverings. It is quick and easy to install in all weather conditions and provides a neat finish.

FEATURES

- Two products:
 - Bonding Strip High Profile – with a central upstand of 100mm
 - Bonding Strip Low Profile – with a central upstand of 70mm
- Available in standard lead grey colour
- Lightweight and flexible
- Safe and easy to cut
- Manufactured from long-lasting UV-resistant Glass Reinforced Polyester (GRP)

COMPATIBILITY

- If one of the roof slopes has high profiled tiles, the Bonding Strip High Profile will be required

- Bonding Strip High Profile is compatible with Plain Tile, Heathland, Rosemary Clay plain tiles and all BMI Redland profiled tiles
- Bonding Strip Low Profile is compatible with Cambrian, natural slates, fibre-cement slates, all BMI Redland interlocking flat tiles and DuoPlain

PERFORMANCE

- No sealing or jointing material is required if the following overlaps and rafter pitches are used:
 - Below 22.5°: 350mm
 - 22.5° - 29.5°: 300mm
 - 30° - 39.5°: 200mm
 - 40° and above: 150mm

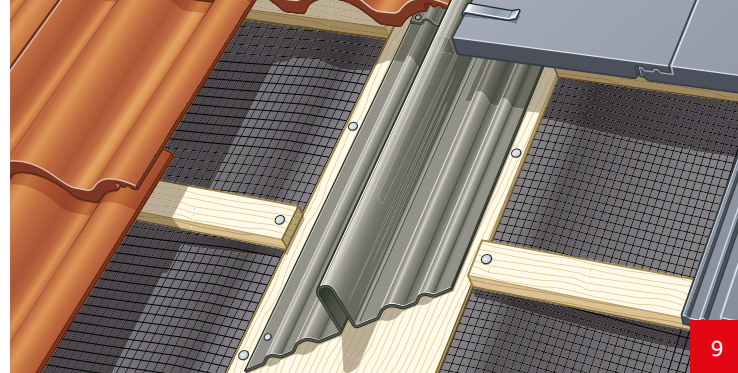

HIGH PROFILE BONDING STRIP (MINI STONEWOLD SLATE / GROVEBURY)

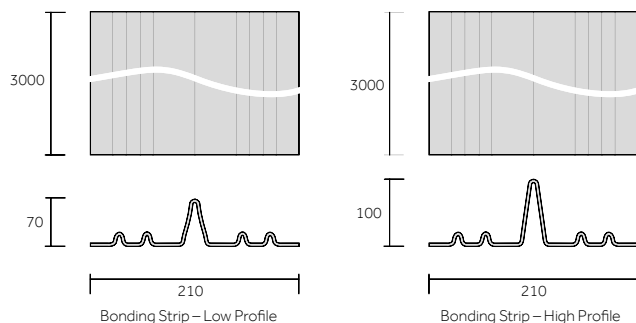
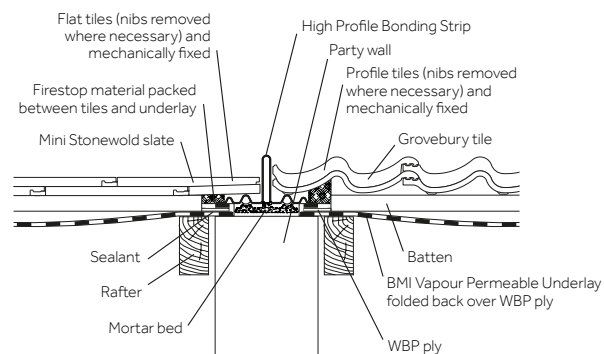

COMPONENTS

Bonding Strip

Size	3m x 0.21m
Material	Glass Reinforced Polyester (GRP)

PRODUCT CODES

	Previous code	Code
Bonding Strip – Low Profile	958000	20001227
Bonding Strip – High Profile	957800	20001226

 This product is suitable for use as part of a BMI Redland specified roof system covered by a **SpecMaster 15 year Guarantee**

Side Abutment GRP Secret Gutter

Offers a secondary line of defence against winddriven rain where a roof slope abuts a vertical wall. Being easy to cut and install makes this product an ideal solution for these otherwise complicated details.

FEATURES

- Lightweight, easy to handle
3 metre lengths

COMPATIBILITY

- Suitable for all flat interlocking tiles in the BMI Redland range and DuoPlain
- For Cambrian Slates use Standard Slates and Slate-and-a-Halves on alternate courses
- For all other slates use Left-hand Verge Slates with interlock removed and Left-hand Half Slates alternately on left-hand abutments. Use Standard Slates and Right-hand Half Slates alternately on right-hand abutments
- For DuoPlain use Standard Tiles with interlock removed and Left-hand $\frac{3}{4}$ Tiles alternately on left hand abutments. Use Standard Tiles and Right-hand $\frac{3}{4}$ Tiles alternatively on right-hand abutments

- Gutter Overlap:
 - 150mm overlap for rafter pitch 30° and above
 - 200mm overlap for rafter pitch 22.5° - 29.5°
 - 250mm overlap for rafter pitch 17.5° - 22°
 - 300mm overlap for rafter pitch 15° - 17°

PERFORMANCE

- Minimum pitch 15°.
- Maximum pitch 90° (consideration must be given to the maximum and minimum pitch of the chosen tile, see product section of this publication)

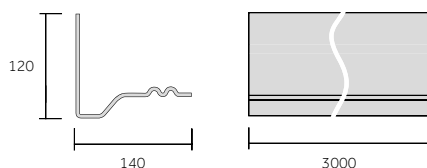

Side Abutment GRP Secret Gutter

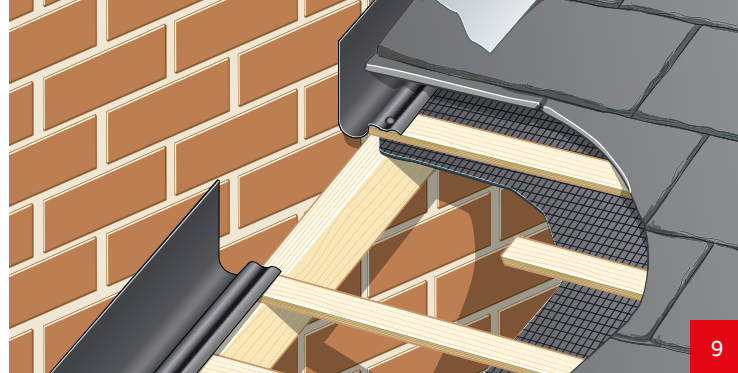

9

SIDE ABUTMENT GRP
SECRET GUTTER

SIDE ABUTMENT GRP SECRET GUTTER (SAXON 10 SLATE)

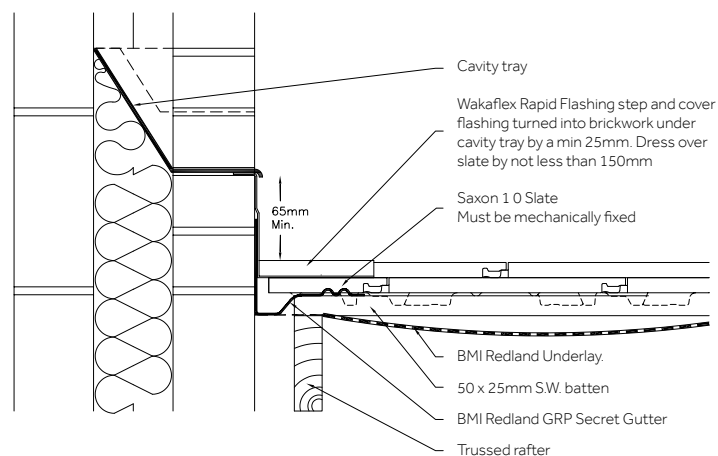

COMPONENTS

Side Abutment GRP Secret Gutter

Gutter Size	3m x 0.095m
Material	Glass Reinforced Polyester (GRP)

PRODUCT CODES

	Previous code	Code
Side Abutment GRP Secret Gutter	959600	20001232



This product is suitable for use as part of a BMI Redland specified roof system covered by a **SpecMaster** 15 year Guarantee

Top Edge Abutment Ventilation System

Provides a continuous, unobtrusive, ventilation path from the roof void to the outside. The innovative design enables the system and cover flashing to be installed far quicker than when traditional methods are used.

FEATURES

- Ventilates to comply with BS 5250, therefore reducing the risk of harmful condensation in the roof
- Tried and tested and complies with BS 5534 requirements for mechanical fixing
- Profile filler units bespoke to each tile type
- Ideal for lean-to-extensions

COMPATIBILITY

- Available for all tiles and slates in the BMI Redland range except Fenland Pantile and Redland 49
- For natural slate contact Technical Services on 0330 123 4585
- Can be used in conjunction with either lead or Wakaflex Rapid Flashing

PERFORMANCE

- Minimum pitch will depend upon the minimum pitch of the roof tiles but must not be less than 15°
- Maximum pitch 60°
- The effective ventilation area per metre run of abutment is 5,000mm²

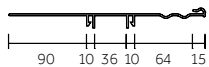

Lead Support Tray

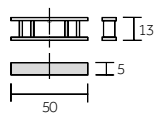

Spacer Block

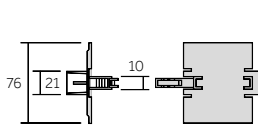

Ratchet Clip

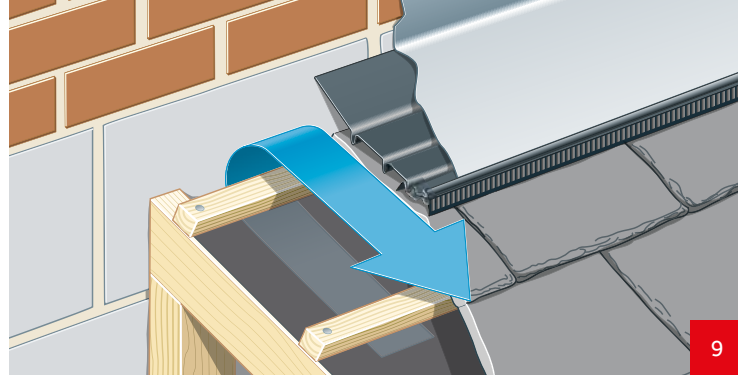
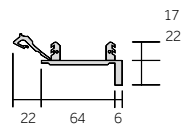

TOP EDGE ABUTMENT VENTILATION SYSTEM (CAMBRIAN)

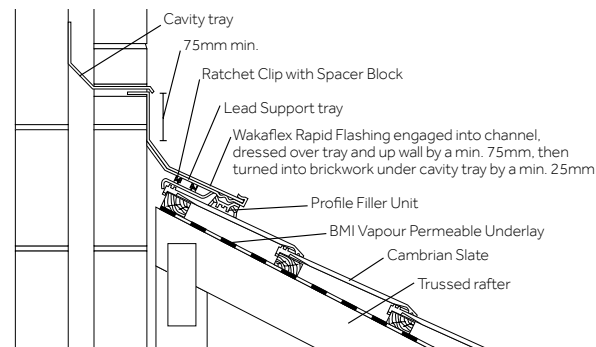

COMPONENTS

Each pack contains sufficient components for 3m of abutment:

- Profile Filler Units (uPVC – grey) (tile specific) | Qty: 7
- Lead Support Trays (uPVC – grey) | Qty: 3
- Ratchet Clips and Spacer Blocks (uPVC – grey) | Qty: 10

PRODUCT CODES	Previous code	Code
Grovebury	954100	10002834
Regent	954200	10002835
50 Double Roman	954300	10002836
Renown	954400	10002837
Flat Tiles and Slates	954800	10002838



This product is suitable for use as part of a BMI Redland specified roof system covered by a **SpecMaster** 15 year Guarantee

RedLine Vent Tile

Provides roof space ventilation through the leading edge of the tile ensuring that the clean lines of the roof are maintained. It is ideal for use where alternative eaves and ridge ventilation systems are not appropriate.

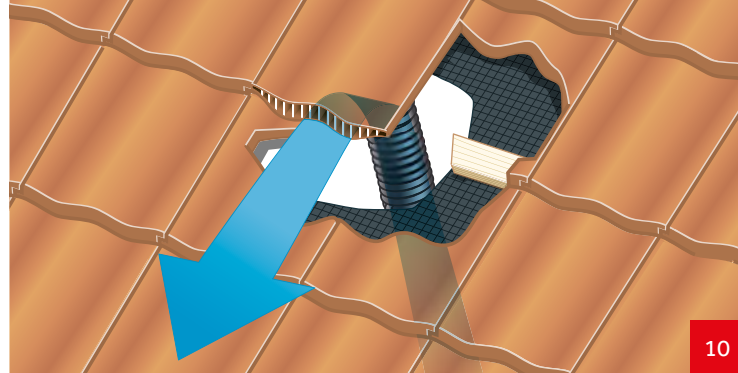

FEATURES

- Three variants available: Interlocking, Plain Tile and DuoPlain
- Minimal visual impact
- Identical interlocks to the tiles ensure a simple and weathertight installation
- Ventilates to comply with BS 5250, therefore reducing the risk of harmful condensation in the roof
- Tried and tested and complies with BS 5534 requirements for mechanical fixing
- Complies with BS EN 12056-2 Gravity Drainage Systems Inside Buildings

COMPONENTS

Each pack contains:

- 1 x Vent (UV protected Medium Density Polyethylene (MDPE) – PVC for BMI Redland DuoPlain)
- 1 x Underlay Seal
- Complete fixing instructions

ACCESSORIES

(sold separately)

- Flexible Pipe to connect to a 110mm soil vent or mechanical extract pipe
- Tile Adaptor

PERFORMANCE

- The pitch range of each RedLine Vent Tile will depend upon the minimum and maximum pitch of the relevant tile profile
- Maximum headlap is the same as that for the relevant tile profile
- The effective ventilation area is 6,000mm² (except DuoPlain which is 7,850mm²)
- To achieve roof space ventilation of 5,000mm² per metre of run, install at 1.2m centres (except DuoPlain 1.57m)
- To achieve roof space ventilation of 10,000mm² per metre of run, install at 0.6m centres (except DuoPlain 0.78m)

Can also be used for:

- Mechanical extraction ventilation

REDLINE VENT TILE (INTERLOCKING) CONNECTED TO FLEXIBLE PIPE (REGENT)

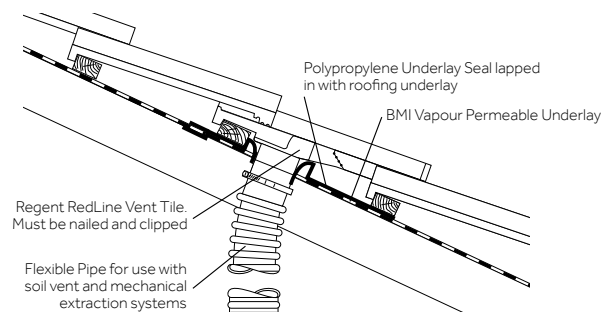

PRESSURE/AIR-FLOW RESISTANCE (Pa)

Tile profile	Air-Flow Rate (L/sec)		
	15	30	60
Regent			
Grovebury			
50 Double Roman	29	116	464
Renown			
Saxon 10			
Richmond 10	32	128	512
MockBond Richmond 10			
Mini Stonewold			
MockBond Mini Stonewold	22	88	352
DuoPlain	35	140	560
Plain Tile	34	136	544



This product is suitable for use as part of a BMI Redland specified roof system covered by a **SpecMaster** 15 year Guarantee

REDLINE VENT TILE COMPONENTS

REDLINE VENT TILE: PLAIN TILE

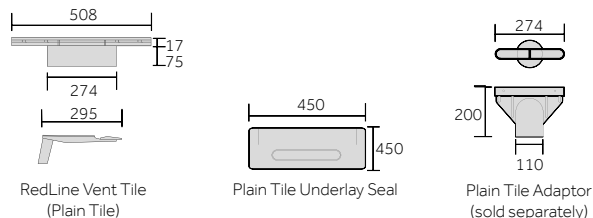

REDLINE VENT TILE: DUOPLAIN

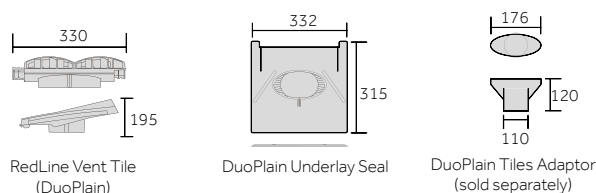

REDLINE VENT TILE: INTERLOCKING TILES

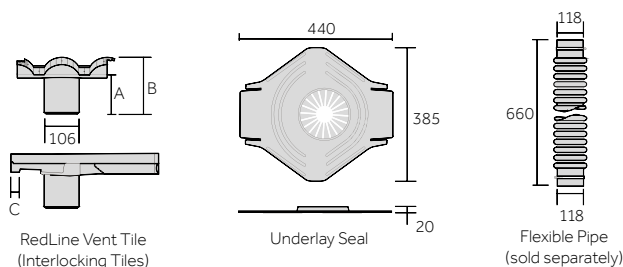

PRODUCT MEASUREMENTS (MM)

Tile profile	A	B	C
Regent	113	180	32
Grovebury	108	172	34
50 Double Roman	114	168	31
Renown	110	159	31
Slate 10 Range	124	165	32
Mini Stonewold	119	149	30

PRODUCT CODES

	Previous code	Code
PLAIN TILE		
Rosemary RedLine Vent Blue Brindle	911987	20001134
Rosemary RedLine Vent Dark Antique	911995	20001135
Rosemary RedLine Vent Medium Mixed Brindle	911982	20001133
Rosemary RedLine Vent Red	911980	20001132
Rosemary RedLine Vent Heather Brindle	911926	20001125
Rosemary RedLine Vent Russet Mix	911918	20001122
Heathland RedLine Vent Autumn	911923	20001124
Plain Tile RedLine Vent Antique Red	911903	20001120
Plain Tile RedLine Vent Black	911963	20001130
Plain Tile RedLine Vent Brown	911902	20001119
Plain Tile RedLine Vent Cotswold	911912	20001121
Plain Tile RedLine Vent Natural Red	911927	20001126
Plain Tile RedLine Vent Rustic Red	911978	20001131
Plain Tile RedLine Vent Slate Grey	911930	20001127
Plain Tile RedLine Vent Terracotta	911934	20001128
Plain Tile RedLine Vent Tudor Brown	911936	20001129
DUOPLAIN		
DuoPlain RedLine Vent Charcoal Grey	911377	10002764
DuoPlain RedLine Vent Red	911338	10002761
DuoPlain RedLine Vent Rustic Brown	911340	10002762
DuoPlain RedLine Vent Rustic Red	911378	10002765
INTERLOCKING FLAT		
Mini Stonewold RedLine Vent Charcoal Grey	911877	20001118
Mini Stonewold RedLine Vent Farmhouse Red	911839	20001115
Mini Stonewold RedLine Vent Black	911863	20001117
Mini Stonewold RedLine Vent Breckland Brown	911852	20001116
Mini Stonewold RedLine Vent Slate Grey	911830	20001112
Mini Stonewold RedLine Vent Terracotta	911834	20001113
Mini Stonewold RedLine Vent Tudor Brown	911836	20001114
Slate 10 range RedLine Vent Black	-	20001141
Slate 10 range RedLine Vent Rustic Brown	-	20001140
Slate 10 range RedLine Vent Slate Grey	-	20001138
Slate 10 range RedLine Vent Flame Red	-	20001139
INTERLOCKING PROFILE		
Grovebury RedLine Vent Charcoal Grey	911477	20001094
Grovebury RedLine Vent Breckland Brown	911452	20001093
Grovebury RedLine Vent Rustic Red	911478	20001095
Grovebury RedLine Vent Slate Grey	911430	20001089
Grovebury RedLine Vent Terracotta	911434	20001090
Grovebury RedLine Vent Tudor Brown	911436	20001091
50 Double Roman RedLine Vent Farmhouse Red	911739	20001109
50 Double Roman RedLine Vent Breckland Brown	911752	20001110
50 Double Roman RedLine Vent Rustic Red	911778	20001111
50 Double Roman RedLine Vent Slate Grey	911730	20001106
50 Double Roman RedLine Vent Terracotta	911734	20001107
50 Double Roman RedLine Vent Tudor Brown	911736	20001108
Regent RedLine Vent Farmhouse Red	911539	20001099
Regent RedLine Vent Slate Grey	911530	20001096
Regent RedLine Vent Tudor Brown	911536	20001098
Renown RedLine Vent Farmhouse Red	911639	20001104
Renown RedLine Vent Breckland Brown	911652	20001105
Renown RedLine Vent Slate Grey	911630	20001101
Renown RedLine Vent Tudor Brown	911636	20001103
Renown RedLine Vent Terracotta	-	20001102

ThruVent Tile

Provides a means of incorporating ventilation within the roof slope where alternative eaves and ridge ventilation systems are not appropriate. It can also be used for mechanical extraction and soil pipe ventilation.

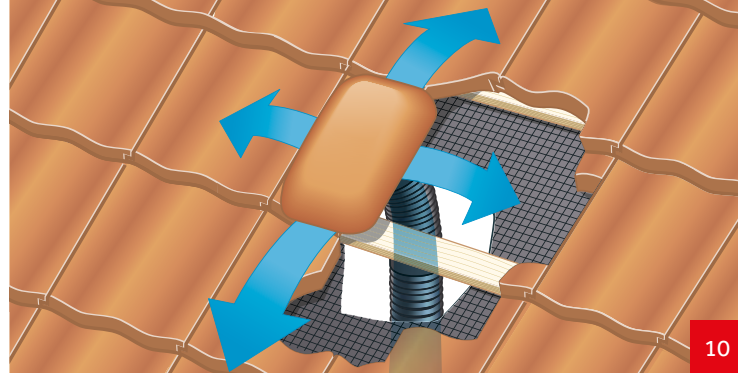

FEATURES

- Ventilates to comply with BS 5250, therefore reducing the risk of harmful condensation in the roof
- Tried and tested and complies with BS 5534 requirements for mechanical fixing
- Complies with BS EN 12056-2, Gravity Drainage Systems Inside Buildings

COMPATIBILITY

- Available for all tiles and slates in the BMI Redland range in all colours (except DuoPlain, Rosemary, and Heathland)

PERFORMANCE

- Minimum and maximum pitch will depend on the profile and surface finish
- Minimum and maximum headlap will depend on the tile profile
- To achieve the specified roof space ventilation the ThruVent tiles should be spaced according to the table below

Can also be used for:

- Mechanical extraction ventilation
- Soil ventilation: Use 4.5k for low rise building (up to 2 storey). No building height restriction applies to the 8.8k ThruVent Tile

4.5K ThruVent TILE CONNECTED TO FLEXIBLE PIPE (Redland 49)

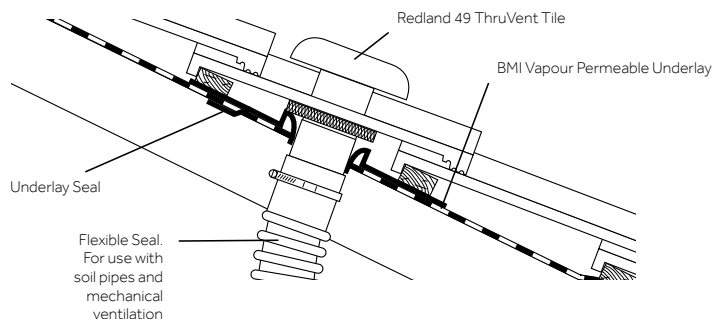

4.5K THRUVENT TILE COMPONENTS

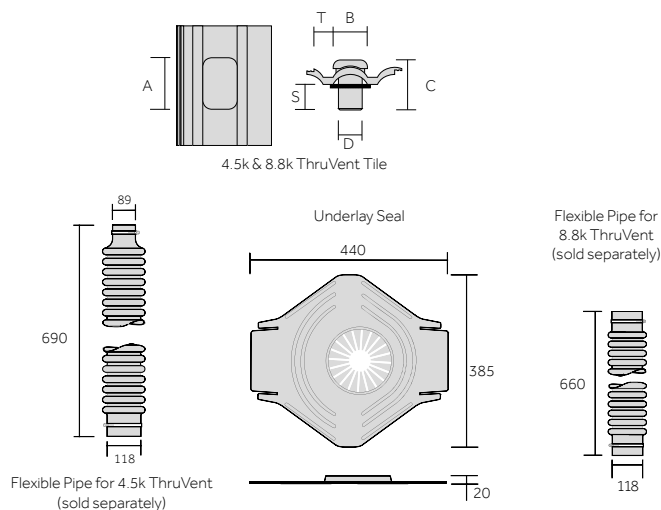

PRODUCT MEASUREMENTS (MM)

TILE PROFILE	S	T
4.5k ThruVent Tile (A=180, B=120, C=175, D=83)		
Cambrian Slate	124	60
Fenland Pantile	122	33
Redland 49	107	40
8.8k ThruVent Tile (A=303, B=202, C=200, D=109)		
Saxon 10 & Richmond 10 (inc MockBond)	116	24
Mini Stonewold (inc MockBond)	112	22
Grovebury	93	31
50 Double Roman	102	23
Regent	94	21
Renown	113	26



This product is suitable for use as part of a BMI Redland specified roof system covered by a **SpecMaster 15 year Guarantee**

COMPONENTS

- The ThruVent Tile is manufactured in concrete or clay with a PVC ventilation unit and cap. The caps are colour coordinated to the colour of the tile base
- Each ThruVent Tile is supplied with a Underlay Seal

Each pack contains:

- 1 x ThruVent (concrete or clay and PVC)
- 1 x Underlay Seal

THRUVENT PERFORMANCE / SPACING

ThruVent	Roof space ventilation (mm ² /m)	ThruVent spacing (m)
4.5k	5,000	0.9
4.5k	10,000	0.45
8.8k	5,000	1.76
8.8k	10,000	0.88
8.8k	25,000	0.35

PRODUCT CODES

	Previous code	Code
4.5K THRUVENT		
Cambrian 4.5k ThruVent Heather	770528	10002317
Cambrian 4.5k ThruVent Slate Grey	770530	10002319
Cambrian 4.5k ThruVent Pre Weathered Slate Grey	770531	10002320
Fenland Pantile 4.5k ThruVent Breckland Brown	732852	10002179
Fenland Pantile 4.5k ThruVent Terracotta	732834	10002176
Fenland Pantile 4.5k ThruVent Farmhouse Red	732839	10002178
Fenland Pantile 4.5k ThruVent Black	732863	10002180
Redland 49 4.5k ThruVent Brown	733402	10002181
Redland 49 4.5k ThruVent Antique Red	733403	10002182
Redland 49 4.5k ThruVent Breckland Brown	733452	10002187
Redland 49 4.5k ThruVent Slate Grey	733430	10002183
Redland 49 4.5k ThruVent Terracotta	733434	10002184
Redland 49 4.5k ThruVent Tudor Brown	733436	10002185
Redland 49 4.5k ThruVent Farmhouse Red	733439	10002186
Redland 49 4.5k ThruVent Rustic Red	733478	10002188
8.8K THRUVENT		
Saxon 10 8.8k ThruVent Black	794463	10002469
Richmond 10 8.8k ThruVent Slate Grey	794330	10002464
Richmond 10 8.8k ThruVent Flame Red	794338	10002465
Richmond 10 8.8k ThruVent Black	794363	10002467
Richmond 10 8.8k ThruVent Rustic Brown	794340	10002466

PRODUCT CODES

	Previous code	Code
Mini Stonewold 8.8k ThruVent Breckland Brown	793552	10002457
Mini Stonewold 8.8k ThruVent Slate Grey	793530	10002453
Mini Stonewold 8.8k ThruVent Terracotta	793534	10002454
Mini Stonewold 8.8k ThruVent Tudor Brown	793536	10002455
Mini Stonewold 8.8k ThruVent Farmhouse Red	793539	10002456
Mini Stonewold 8.8k ThruVent Charcoal Grey	793577	11000227
Mini Stonewold 8.8k ThruVent Black	793563	10002458
Grovebury 8.8k ThruVent Breckland Brown	793152	10002435
Grovebury 8.8k ThruVent Slate Grey	793130	10002431
Grovebury 8.8k ThruVent Terracotta	793134	10002432
Grovebury 8.8k ThruVent Tudor Brown	793136	10002433
Grovebury 8.8k ThruVent Farmhouse Red	793139	10002434
50 Double Roman 8.8k ThruVent Breckland Brown	793352	10002450
50 Double Roman 8.8k ThruVent Slate Grey	793330	10002446
50 Double Roman 8.8k ThruVent Terracotta	793334	10002447
50 Double Roman 8.8k ThruVent Tudor Brown	793336	10002448
50 Double Roman 8.8k ThruVent Farmhouse Red	793339	10002449
Regent 8.8k ThruVent Slate Grey	793030	10002423
Regent 8.8k ThruVent Tudor Brown	793036	10002425
Regent 8.8k ThruVent Farmhouse Red	793039	10002426
Renown 8.8k ThruVent Breckland Brown	793252	10002442
Renown 8.8k ThruVent Slate Grey	793230	10002438
Renown 8.8k ThruVent Tudor Brown	793236	10002440
Renown 8.8k ThruVent Farmhouse Red	793239	10002441

Rapid Roof Vent Tile

A range of discreet ventilating tiles suitable for both low and high-level roof space ventilation, to combat condensation, as well as mechanical and soil pipe ventilation. Suitable for use with most popular interlocking concrete tiles and plain tiles.

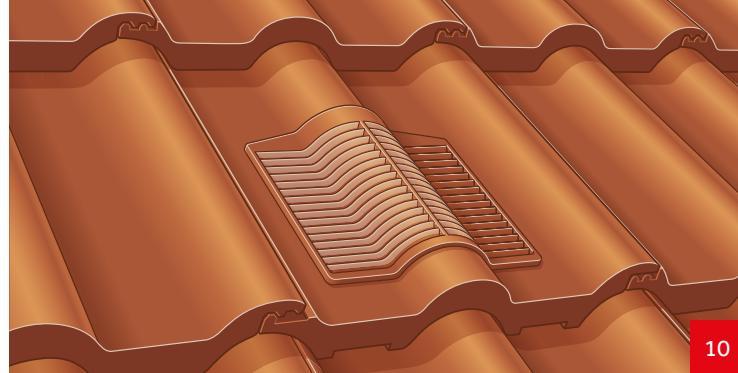

FEATURES

- Ventilates to comply with BS 5250, therefore reducing the risk of harmful condensation in the roof
- Discreet design matches the aesthetics of the roof
- Excellent weather performance
- Rigid construction, high quality
- Complies with BS EN 12056-2, Gravity Drainage Systems Inside Buildings

COMPATIBILITY

- Complies with NHBC guidelines for high-level ventilation in new build housing
- Suitable for Saxon 10 Slate, Richmond 10 Slate (inc MockBond), Renown, 50 Double Roman, Grovebury, Mini Stonewold (inc MockBond) and concrete Plain Tiles in a range of colours

PERFORMANCE

- The effective ventilation area is 10,000mm² (except Plain Tile which is 6,500mm²)

COMPONENTS

Each pack contains:

- 1 x Vent
- 1 x Underlay Seal

Also available (sold separately)

- Interlocking Tiles Pipe Adaptor or Plain Tiles Pipe Adaptor
- Flexible Pipe

RAPID ROOF VENT TILE CONNECTED TO FLEXIBLE PIPE (REGENT / GROVEBURY)

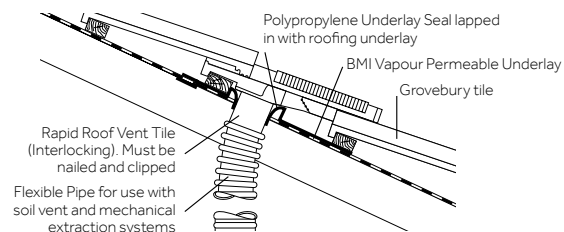

RAPID ROOF VENT TILE COLOUR SELECTOR

Tile type	Tile colour	Vent colour
Mini Stonewold	Slate Grey	Grey
MockBond Mini Stonewold	Terracotta	Terracotta
Grovebury	Tudor Brown	Brown
Renown	Farmhouse Red	Terracotta
50 Double Roman	Breckland Brown	Brown
Plain Tile	Brown	Dark Brown
	Antique Red	Red
	Terracotta	Terracotta
	Tudor Brown	Brown
	Farmhouse Red	Terracotta
	Breckland Brown	Brown
Saxon 10 / Richmond 10 / MockBond Richmond 10	Rustic Red	Red
	Slate Grey	Grey
	Flame Red	Terracotta
	Rustic Brown	Brown
	Black	Black

RAPID ROOF VENT TILE COMPONENTS

RAPID ROOF VENT: PLAIN TILE

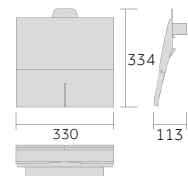

Plain Tile
Rapid Roof Vent

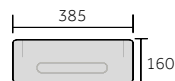

Plain Tile Underlay Seal

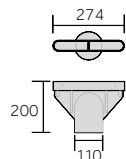

Plain Tile
Pipe Adaptor (sold separately)

RAPID ROOF VENT: INTERLOCKING TILE

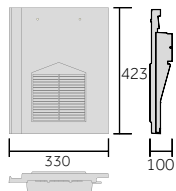

Interlocking Tiles
Rapid Roof Vent

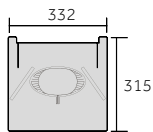

Interlocking Tiles
Underlay Seal

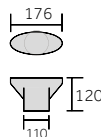

Interlocking Tiles
Pipe Adaptor (sold separately)

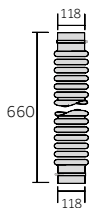

Flexible Pipe
(sold separately)

RAPID ROOF VENT PERFORMANCE / SPACING

Rapid Roof Vent	Roof space ventilation (mm ² /m)	Vent spacing (m)
Interlocking	5,000	2
	10,000	1
	25,000	0.4
Plain Tile	5,000	1.3
	10,000	0.65
	25,000	0.26

PRODUCT CODES

PLAIN TILE

	Previous code	Code
Plain Tile Rapid Roof Vent Brown	912836	10002789
Plain Tile Rapid Roof Vent Grey	912830	10002787
Plain Tile Rapid Roof Vent Terracotta	912834	10002788
Plain Tile Rapid Roof Vent Dark Brown	912802	10002785
Plain Tile Rapid Roof Vent Red	912803	10002786

INTERLOCKING FLAT

Slate 10 Rapid Roof Vent Brown	912336	10002768
Slate 10 Rapid Roof Vent Black	912363	10002769
Slate 10 Rapid Roof Vent Grey	912330	10002766
Slate 10 Rapid Roof Vent Terracotta	912334	10002767
Mini Stonewold Rapid Roof Vent Grey	912430	10002770
Mini Stonewold Rapid Roof Vent Terracotta	912434	10002771
Mini Stonewold Rapid Roof Vent Brown	912436	10002772

INTERLOCKING PROFILE

Grovebury Rapid Roof Vent Brown	912636	10002780
Grovebury Rapid Roof Vent Terracotta	912634	10002779
Grovebury Rapid Roof Vent Red	912603	11000228
Grovebury Rapid Roof Vent Grey	912630	10002778
50 Double Roman Rapid Roof Vent Brown	912536	10002776
50 Double Roman Rapid Roof Vent Terracotta	912534	10002775
50 Double Roman Rapid Roof Vent Red	912503	10002773
50 Double Roman Rapid Roof Vent Grey	912530	10002774
Renown Rapid Roof Vent Brown	912736	10002783
Renown Rapid Roof Vent Grey	912730	10002781
Renown Rapid Roof Vent Terracotta	912734	10002782

Wakaflex Rapid Flashing

Can be used instead of lead for the majority of pitched roof applications. The unrivalled speed and ease of installation enables standard flashing details to be completed twice as quickly as with lead, offering a viable and safer alternative to traditional methods.

FEATURES

- Appearance of lead, grey colour
- Lighter weight than lead and easy to use
- Can be moulded quickly and easily, without the need for special tools
- No welding required, thanks to the self-fusing properties of the material
- Insensitive to extremes of cold and heat (-40° to +100°C)
- No scrap value means Wakaflex Rapid Flashing is not at risk of theft
- 20-year product guarantee
- Low site wastage due to ease of cutting and simple fixing
- Non-toxic

COMPATIBILITY

- Compatible with all BMI Redland tiles and slates
- Suitable for use with most pitched roofing materials

PERFORMANCE

- Awarded British Board of Agrément Certification, certificate number 09/4622

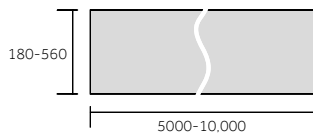

Wakaflex Rapid Flashing

COMPONENTS

COLOURFAST PLASTIC WITH ALUMINIUM RIB MESH INSERT AND BUTYL SEALING EDGE

Size	Weight	Rolls/Box	Previous code	Code
180mm x 5m	3.1kg	4	996030	10002893
280mm x 5m	4.8kg	4	995530	10002886
370mm x 5m	6.3kg	3	995730	10002889
560mm x 5m	9.6kg	2	995930	10002892

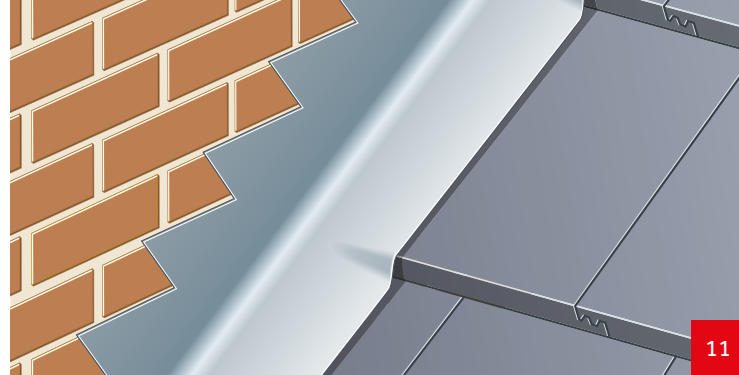

TRADITIONAL STEP AND COVER FLASHING – FLAT INTERLOCKING TILES

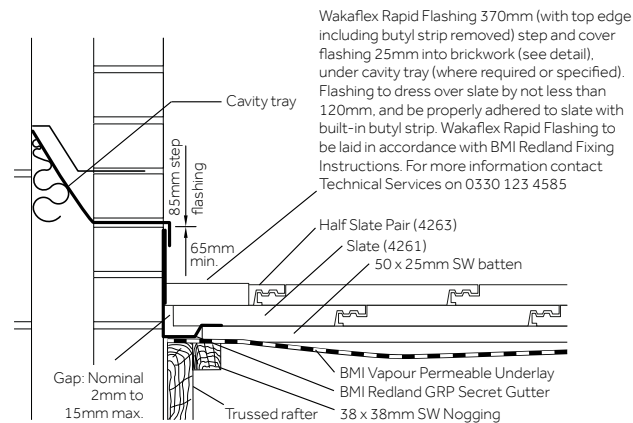

This product is suitable for use as part of a BMI Redland specified roof system covered by a **SpecMaster** 15 year Guarantee

Mortar Bedded Fixing Kit

The BMI Redland Mortar Bedded Fixing Kit is the most effective way to mechanically fix mortar bedded ridges and hips. It maintains a traditional aesthetic, whilst complying with BS 5534 and NHBC Technical Standards.

FEATURES

- Maintains a traditional look
- Simple to use. Very similar to standard mortar bedding installation
- One system to be used for both ridges and hips
- Complies with BS 5534 requirements for mechanical fixing
- Complies with NHBC Guidelines for mechanical fixing

COMPATIBILITY

- Fully compatible with all BMI Redland tiles
- Suitable for traditional timber rafter, timber trussed rafter and rigid sarking constructions
- Compatible with most other tiles and slates

COMPONENTS

Each Mortar Bedded Fixing Kit contains sufficient components to secure 5m of concrete ridge or hip tiles or 3.3m of clay ridge or hip tiles. Each pack contains:

- 8 x Batten Straps (Stainless Steel)
- 11 x Universal Angle Clamping Plates (Stainless Steel)
- 16 x Batten Strap Nails (Stainless Steel)
- 11 x 100mm Woodscrews (Stainless Steel)

PRODUCT CODE	Previous code	Code
Mortar Bedded Fixing Kit	931400	10002814

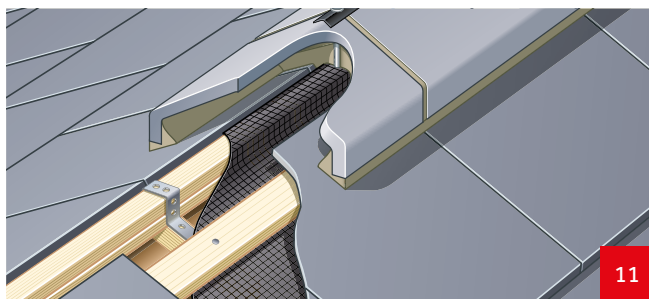

Kro-Clip

Kro-Clip is a versatile clip that allows small roof tile cuts to be mechanically fixed in accordance with BS 5534, particularly at hips and valleys.

FEATURES

- Robust solution to the long-standing problem of fixing small cut tiles
- Quick and easy to fit
- Firmly grips the side of the tile
- Suitable for numerous roofing details such as at hips and valleys and around roof windows, dormers and solar PV panels
- Mechanical fixing for consistent results, removing the need for glue which requires optimum conditions for use
- Supplied in convenient boxes of 50 clips
- Universal fit covering a large range of tile types

COMPATIBILITY

- Works with any tile from 8-16mm thickness, including Plain Tiles and DuoPlain, or where the cut section of the tile is 8-16mm thick
- Not suitable for Cambrian Slate

PERFORMANCE

- The rigid clip is secured to the roof tile using a hammer. The attached wire is then wound around a nail which itself is secured to a convenient structural timber fixing point, e.g. a tiling batten, ridge or hip rafter
- The Kro-Clip can be used either on its own or in combination with other clips such as the BMI Redland C-Clip to provide secure head and/or tail fixings for small roof tile cuts and other difficult to fix roof tiles

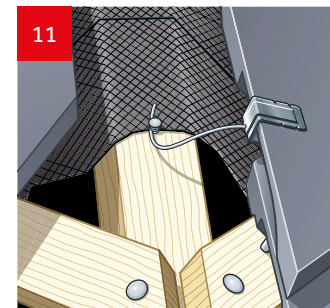

COMPONENTS

Material	Stainless Steel
Size	30mm long clip with 380mm attached wire
Box Quantity	50

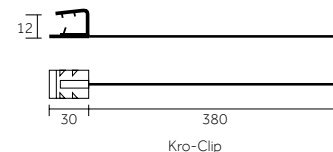

PRODUCT CODE	Previous code	Code
Kro-Clip	914200	10003245

 This product is suitable for use as part of a BMI Redland specified roof system covered by a **SpecMaster** 15 year Guarantee

This product is suitable for use as part of a BMI Redland specified roof system covered by a **SpecMaster** 15 year Guarantee 

Innofix Clip

Innofix is the multi award-winning revolutionary tool-free tile clip. Simple to fix, with less tile breakage and quicker than ever to install. It's our strongest clip yet, and suitable for all UK exposures in accordance with BS 5534.

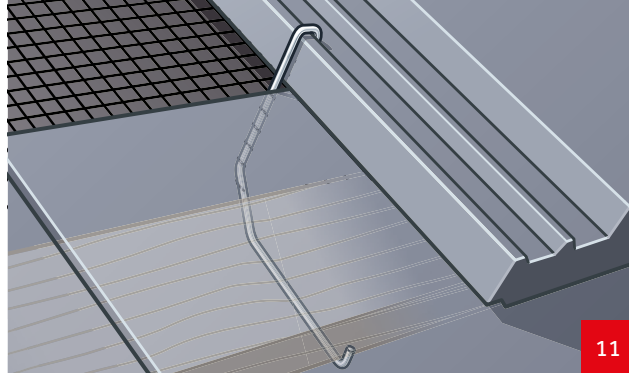

FEATURES

- Five sizes available to suit all BMI Redland concrete interlocking tiles
- Tool-free – quick and simple to fix
- Unique clip magazine allowing tangle-free usage
- Colour-coded for error-free identification
- Award-winning design

COMPATIBILITY

- Innofix Clips are compatible with the following tiles:
 - Red: Grovebury, Regent, and Fenland Pantile
 - Light Blue: 50 Double Roman
 - Light Orange: Redland 49 and Renown
 - Gold: Mini Stonewold and MockBond Mini Stonewold
 - Purple: Richmond 10 Slate, MockBond Richmond 10 Slate, Saxon 10 Slate and DuoPlain
- For the tile course immediately above a sprocket, it is necessary to use the next colour up i.e. instead of Purple use Gold, instead of Gold use Light Orange, instead of Light Orange use Light Blue, instead of Light Blue use Red
- Must be used in conjunction with a 50 x 25 mm tiling batten only

PERFORMANCE

- Up to 40% quicker to install than traditional nailed clips
- Suitable for all exposure zones under BS 5534
- Rustproof and made to last the lifetime of the roof
- Quickest ever clip to install
- Storm-proof - very high resistance to wind uplift

COMPONENTS

Material	Stainless Steel
Box Quantity	250 clips
50 x 25mm tiling battens only	
Size (mm):	Five sizes available to suit all Redland concrete interlocking tiles

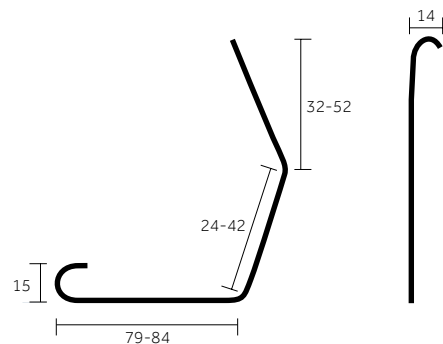

Innofix Clip

If using counterbattens they must be minimum 15mm high

PRODUCT CODES	Previous code	Code
Innofix Clip Red (250)	982100	11000253
Innofix Clip Light Blue (250)	982200	11000252
Innofix Clip Orange (250)	982300	11000230
Innofix Clip Gold (250)	982400	11000231
Innofix Clip Purple (250)	982500	11000229



This product is suitable for use as part of a BMI Redland specified roof system covered by a **SpecMaster** 15 year Guarantee

Hip End Cap

Hip End Caps are the modern way to complete a dry hip installation. Cost-effective and quick-to-install, **Hip End Caps** are compatible with all BMI Redland dry hip systems providing a neat, colour-matched finish to the hip end.

FEATURES

- Available in both Universal Angle and Third Round profiles
- Available in Black and Terracotta. Third Round additionally available in Brown
- Quick and easy to install
- Lightweight, high-impact construction

COMPATIBILITY

- Third Round Hip End Cap designed for use with Rosemary clay and BMI Redland concrete hip tiles or equivalent hip tile profiles
- Universal Angle Hip End Cap designed for use with both concrete and clay universal angle hip tiles
- Colour matched to suit most hip tiles



COMPONENTS

Material High impact Polystyrene

PRODUCT CODES	Previous code	Code
Hip End Cap - Universal Angle Terracotta	970434	10002848
Hip End Cap - Universal Angle Black	970463	10002849
Hip End Cap - Third Round Terracotta	971234	10002850
Hip End Cap - Third Round Brown	971236	10002851
Hip End Cap - Third Round Black	971263	10002852

Ridge End Cap

Ridge End Caps are the easy way to complete a dry ridge installation. Cost-effective and quick-to-install, **Ridge End Caps** are designed to work seamlessly with BMI Redland DryVerge systems to give a neat, weathertight, colour-matched aesthetically pleasing finish to a roof system.

FEATURES

- Available in Universal Angle and Half Round designs
- Quick and easy to install
- Maintenance-free
- Complies with NHBC Guidelines for mechanical fixing

COMPATIBILITY

- Colour match to Rapid Verge units (Slate Grey, Rust) and our clay Universal Angle Ridge Tiles (Black and Terracotta)
- Half Round Ridge End Cap compatible for use with Rosemary clay and BMI Redland concrete half round ridge tiles or equivalent ridge tile profiles
- Universal Angle Ridge End Cap compatible for use with BMI Redland concrete universal angle ridge tiles or equivalent ridge tile profiles

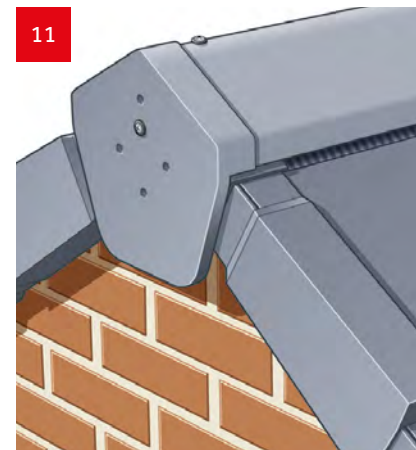

COMPONENTS

Material UV-stable Polypropylene

PRODUCT CODES	Previous code	Code
Ridge End Cap - Half Round Slate Grey	977230	20001251
Ridge End Cap - Half Round Rust	977255	20001252
Ridge End Cap - Universal Angle Slate Grey	977330	20001254
Ridge End Cap - Universal Angle Terracotta	977334	20001255
Ridge End Cap - Universal Angle Rust	977355	20001256
Ridge End Cap - Universal Angle Black	977363	20001257

Monoridge End Cap

Monoridge End Caps are the easy way to complete a dry ridge installation. Effective and quick-to-install, Monoridge End Caps are designed to work seamlessly with BMI Redland dry verge systems to give a neat, weathertight, colour-matched finish to a roof system.

FEATURES

- Available in Universal Angle and Half Round designs
- Quick and easy to install
- Maintenance-free

COMPATIBILITY

- Colour matched to Rapid DryVerge units (Slate Grey, Rust) and DryVerge (Slate Grey, Terracotta)
- Monoridge End Cap Half Round is compatible for use with Redland concrete Half Round Monoridge tiles or similar monoridge tile profiles
- Monoridge End Cap Universal Angle is compatible for use with Redland concrete Monoridge tiles or similar monoridge tile profiles

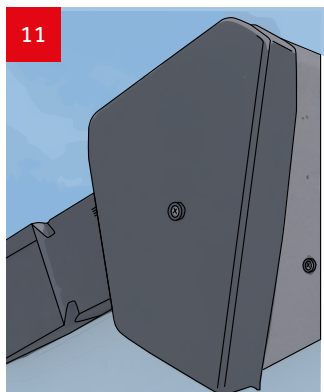

COMPONENTS

Material UV-stable Polypropylene

PRODUCT CODES	Previous code	Code
Monoridge End Cap - Half Round Left Hand (Slate Grey)	976330	20001384
Monoridge End Cap - Half Round Right Hand (Slate Grey)	976430	20001386
Monoridge End Cap - Half Round Left Hand (Rust)	976355	20001385
Monoridge End Cap - Half Round Right Hand (Rust)	976455	20001387
Monoridge End Cap - Universal Angle Left Hand (Slate Grey)	977830	20001388
Monoridge End Cap - Universal Angle Right Hand (Slate Grey)	977930	20001390
Monoridge End Cap - Universal Angle Left Hand (Rust)	977855	20001389
Monoridge End Cap - Universal Angle Right Hand (Rust)	977955	20001391



This product is suitable for use as part of a BMI Redland specified roof system covered by a **SpecMaster 15 year Guarantee**



Best in class training

We provide first class training and application support at our BMI Academy with both practical hands-on training programmes and courses through our e-learning platform.

The BMI Academy delivers training to architects, contractors, housebuilders, merchants, local authorities and housing associations for both pitched and flat roofing.

With an industry-leading mix of theory and practical courses, from RIBA-approved CPDs to installation and estimating courses, the BMI Academy offers the chance to develop and improve knowledge and skills to those in the roofing sector at all levels.

Whether your interest is in the latest British Standards, estimating, dry-fix components, solar, ventilation, or simply getting a better grasp of BMI Redland's systems in order to do your job better, we can accommodate your needs, alongside offering bespoke courses tailored directly to your requirements.



Contact us at the BMI Academy to find out how we can help you with your training needs:

0128 586 3545
bmitraininguk@bmgroupp.com

[bmgroupp.com/uk/bmi-academy](https://www.bmgroupp.com/uk/bmi-academy)



BMI Group UK Limited

BMI House

2 Pitfield

Kiln Farm

Milton Keynes

MK11 3LW

Tel 0370 560 1000

sales.redland@bmigroup.com

BMI Group UK Limited is part of the world's largest roofing and waterproofing manufacturer. A global business specialising in building materials for today's and tomorrow's needs. BMI is a new name, backed-up with over 180 years of experience and knowledge. Bringing together the roofing expertise of industry leading Icopal and Redland and their experience in the specification, manufacture and supply of flat and pitched roofing solutions. United to deliver excellence for our customers.

Learn more at www.bmigroup.com/uk

bmigroup.com/uk